

NEKO
THINK DESIGN

NEKO
THINK DESIGN
www.nekolighting.com

2025

2025

NEKO
THINK DESIGN

NEKO LIGHTING AG
Kreuzstrasse 2
CH-8008 Zürich / Switzerland
+41 44 451 80 15
sales@nekolighting.com
www.nekolighting.com



NEKO
THINK DESIGN
www.nekolighting.com

NEKO vereint europäisches Denken und asiatische Effizienz

Die Schweizer Firma NEKO LIGHTING bietet seit 2013 effiziente und qualitativ hochwertige LED Architekturbeleuchtung zu einem attraktiven Preis-Leistungsverhältnis. Kombiniert werden europäisches Denken und asiatische Effizienz zur gemeinsamen Firmenphilosophie „Think Design“.

Eigentümer ist Sven Speissegger (Schweiz), welcher über eine langjährige und umfangreiche Erfahrung im Beleuchtungsmarkt verfügt.

Firmensitz und Zentrale des Unternehmens sind in der Schweiz. Aktuell betreibt NEKO eine eigene Produktions- und Beschichtungsanlage in China.

In Deutschland, Frankreich, England, Nordamerika/Canada, Peking und Shanghai befinden sich im NEKO Besitz Vertriebsstützpunkte. Eigene Lagerhaltung ist in Deutschland und China vorhanden.

NEKO Leuchten werden exklusiv über ein Distributorennetz in zwischen mehr als 90 Ländern weltweit vertrieben.

Von Beginn an produzierte NEKO nachhaltige LED Leuchten. Für die Produkte setzt NEKO ausschließlich hochwertige LED-Chips namenhafter Hersteller, z. B. Osram, Samsung, Citizen ein. Die verwendeten Treiber besitzen das ENEC-Zeichen.

Jedes NEKO Produkt für den Innenbereich hat eine Garantie von 5 Jahren (NEKO Produkte für den Außenbereich haben 3 Jahre Garantie). 2019 investierte NEKO in die Produktionsanlage und in die lichttechnischen Labore in China. Die Expansion erforderte größere Räume und einen neuen Standort für die Firma.

NEKO
THINK DESIGN
www.nekolighting.com

NEKO: the union of European thinking and asian Efficiency

NEKO LIGHTING provides high quality as well as efficient LED-lighting solutions at a very competitive price/performance ratio since 2013. By uniting European thinking and asian Efficiency NEKO created its corporate philosophy “Think Design”.

NEKO is owned by Sven Speissegger (Switzerland), with a long track record and extensive know-how in the lighting market.

NEKO with its registered and head office in Switzerland owns a production facility as well as a coating plant in China.

The corporation runs with NEKO owned offices in Germany, France, Great Britain, North America/Canada, Beijing and Shanghai.

NEKO lights are exclusively sold via a distributor network in more than 90 countries worldwide.

NEKO LED-lights were sustainably produced right from the beginning and are solely fitted with premium LED-Chips by renowned manufacturers such as Osram, Samsung and Citizen. All drivers installed come with ENEC-labeling.

Every NEKO interior lighting product is backed by a robust 5-Year Warranty, while our exterior lighting products come with a reliable 3-Year Warranty. In 2019, NEKO embarked on an exciting expansion journey driven by the need for larger facilities and a new site, significantly investing in our production facility and state-of-the-art lighting laboratories in China.

NEKO
THINK DESIGN
www.nekolighting.com

NEKO COLORS

Standard white & standard black of NEKO products

RAL 9016

TRAFFIC WHITE

RAL 9005

JET BLACK

Besides standard colors as mentioned in the catalogue, any individual RAL classic color can be custom made.

Details for your individual colors

Have the freedom of design a wide range of NEKO products, can now be ordered in any RAL classic color for indoor lighting

The individual color can be produced for you with a reasonable surcharge.

For this customized color the delivery times will be a bit longer.

Please ask our NEKO sales team to support you.



NEKO
THINK DESIGN

NEKO colors
your life

INDEX

MINUX Series



MINUX 38 ■ 007-008
MINUX 44 ■ 009-010
MINUX 57 ■ 011-012

SENSE 45 Series

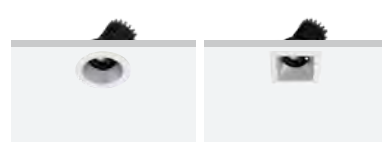

S45R1 ■ 025-026
S45S1 ■ 027-028

SENSE 55 Series

! NEW



S55R1-G2 ■ 031-032

SENSE 68 Series



S68R1-G2 ■ 037-038
S68S1-G2 ■ 039-040

SENSE 75 Series

! NEW



S75R1-G2 ■ 041-042

SENSE 100 Series



S100R1-G2 ■ 049-050
S100S1-G2 ■ 051-052
S100HR1-G2 ■ 053
S100HS1-G2 ■ 054
S100R7-G2 ■ 055
S100HR7-G2 ■ 056
S100R2-G2 ■ 057



S100HR2-G2 ■ 058
S100S2-G2 ■ 059
S100HS2-G2 ■ 060

SENSE 125 Series



S125R1-G2 ■ 065
S125S1-G2 ■ 066
S125R2-G2 ■ 067
S125S2-G2 ■ 068

SENSE 150 Series



S150R1-G2 ■ 071
S150S1-G2 ■ 072
S150R2-G2 ■ 073
S150S2-G2 ■ 074

SENSE New Wall Washer Series

! NEW

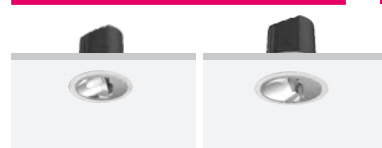

SENSE W75 ■ 079
SENSE W100 ■ 080

TAKEO Round Series

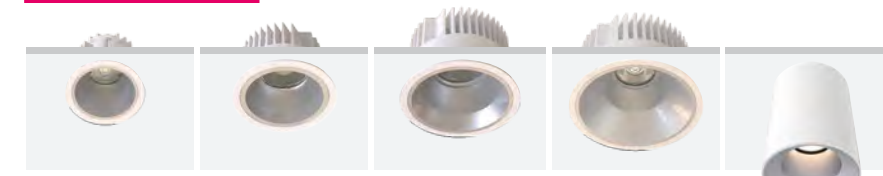

T75 ■ 091-092
T100 Pro ■ 093-096
T150 Pro ■ 097-098
T200 Pro ■ 099-100
T150C Pro ■ 101-102

TAKEO Square Series

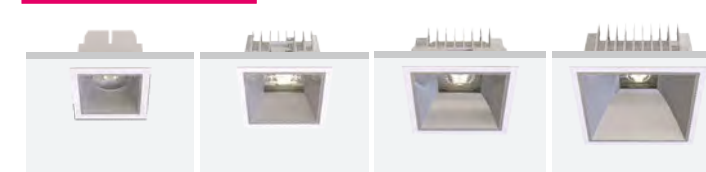

TS68 ■ 105
TS100 Pro ■ 106
TS150 Pro ■ 107
TS200 Pro ■ 108

VISION Series



VISION V68 ■ 111
VISION V68W ■ 112

PASSION Series

! NEW



PASSION 100 ■ 115-116
PASSION 150 ■ 117
PASSION 200 ■ 118

NEKO Code Introduction

[Code_Prefix]-[Electrical-optical Info.]-[Color Info]-[Accessories]

***** - * ** ** * - * * - *

SSR1G2 - 9 30 45 18 D - W S - H

↑ Acronym of Model ↑ CRI ↑ CCT ↑ Beam Angle ↑ Power ↑ Lighting Control ↑ Reflector / Decoration Ring Color ↑ Accessories

SSR1G2-9304518D-WS-H
- SENSE100-G2, Round Trim, Adjustable Version,
- CRI90, CCT3000K, Beam 45°, 18W, DALI Control,
- White Trim, Specular 2nd Reflector,
- with Honeycomb.

CLUB LED Module

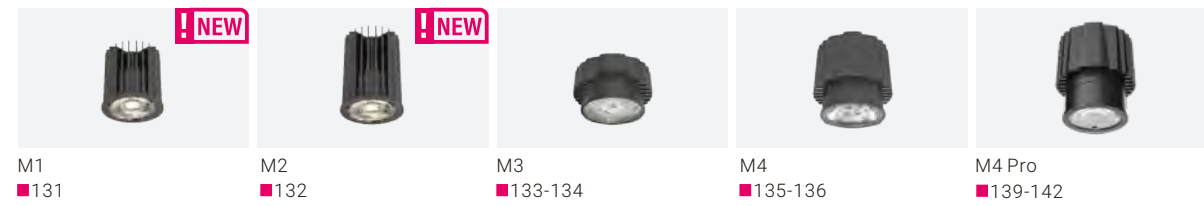

M1 ■131 M2 ■132 M3 ■133-134 M4 ■135-136 M4 Pro ■139-142

CLUB Trim Series



TA5 TA6 TA7 TA8 TF5 TRF1-IP44 TA5-IP65



TSF1 TSA1 TSA2 TSA3



TSA1D TSA2D TSA3D
■143-172

SKYJACK Series

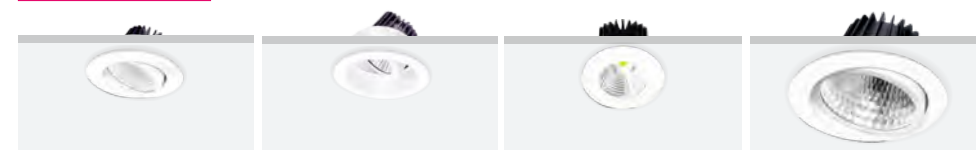

SKYJACK A68 ■175-176 SKYJACK D ■177-178 SKYJACK F ■179-180 SKYJACK A145 ■181-182

KENZO Series



K1X30 ■189 K1X55 ■190 K1X70 ■191-192

FUSION Fixed

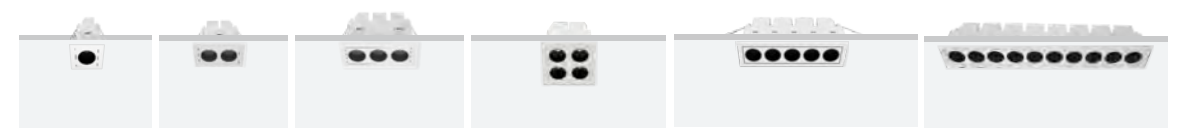

FUSION FF1 ■207-208 FUSION FF2 ■209-210 FUSION FF3 ■211-212 FUSION FX4 ■213-214 FUSION FF5 ■215-216 FUSION FF10 ■217-218

FUSION Fixed IP65

! NEW



FUSION FF2-IP65 ■219 FUSION FF3-IP65 ■220 FUSION FF5-IP65 ■221 FUSION FF10-IP65 ■222

FUSION Adjustable



FUSION FA5 ■223 FUSION FA10 ■225

FUSION Fixed Trimless



FUSION FFT5 ■223 FUSION FFT10 ■225

FUSION Wall Washer



FUSION FW5 ■227-228 FUSION FW10 ■229-230

FUSION General Light



FUSION FG5 ■231 FUSION FG10 ■232

FUSION Adjustable Spotlight



FUSION FS1 ■237 FUSION FS2 ■238 FUSION FS3 ■239 FUSION FS6 ■240



FUSION FF3-FS1 ■241 FUSION FF6-FS2 ■242

FUSION G2 Fixed **! NEW**



FUSION G2 FF1 ■245 FUSION G2 FF2 ■246 FUSION G2 FF3 ■247 FUSION G2 FF5 ■248 FUSION G2 FF10 ■249-250

FUSION G2 Trimless Fixed **! NEW**



FUSION G2 FFT5 ■248 FUSION G2 FFT10 ■249-250

FUSION G2 Adjustable **! NEW**



FUSION G2 FA5 ■251 FUSION G2 FA10 ■252

FUSION Linear System



FUSION Linear System ■253-290

SPACE 60 Linear System

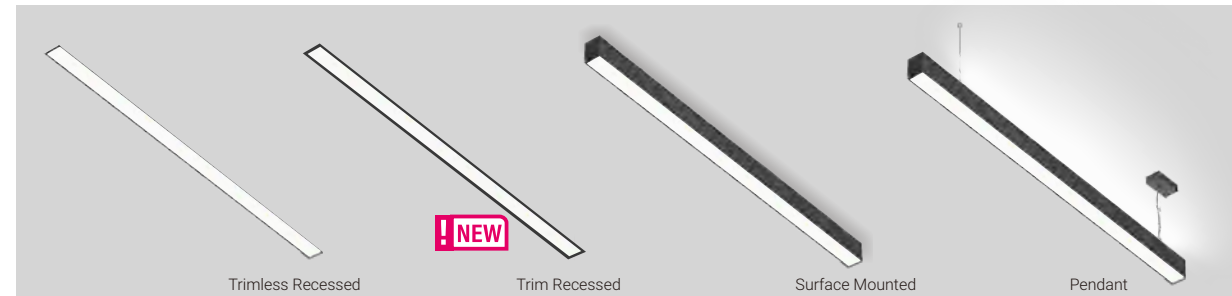

SPACE 60 Linear System ■291-314

MODULINE 05 24V Linear System **! NEW**



MODULINE 05 Linear System ■315-326

MODULINE 26 48V Linear System



MODULINE 26 Linear System ■327-398

GAME Ceiling Light Series



GAME ■405-414

SUGAR Ceiling Light Series



SUGAR ■415-424

GLAMOR Ceiling Light Series



GLAMOR ■425-430

MINT Ceiling Light Series



MINT 280 ■431-436

SKY Family Ceiling Light



SKYDRIVER SDRC ■ 439
 SKYDRIVER SDSC ■ 440
 SKYJOY Single SJSC ■ 441-442
 SKYJOY Double SJDC ■ 443-444
 SKYLINE SL5C ■ 445-446

MIU Series



MIU-C M ■ 451
 MIU-C L ■ 452
 MIU-P S ■ 453
 MIU-P M ■ 454
 MIU-P L ■ 455

MIU Art Series

! NEW



MIU Art-S ■ 459
 MIU Art-M ■ 460

BREEZE Series



BREEZE Single ■ 463-464
 BREEZE Double ■ 465
 BREEZE Triple ■ 466

VIBES Series

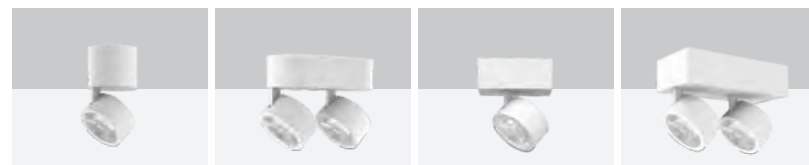

V1RC ■ 469
 V2RC ■ 470
 V1SC ■ 471
 V2SC ■ 472



V1RR ■ 473
 V2RR ■ 474
 V1SR ■ 475
 V2SR ■ 476

Ceiling Mounted PURE Series



PURE Art-C ■ 479
 PURE S-C ■ 480

PURE Series Tracklight



PURE ART ■ 491-492
 PURE S ■ 493-494
 PURE M ■ 495-496

ROXY Series Tracklight



ROXY ART ■ 503-504
 ROXY S ■ 505-506
 ROXY K ■ 507-508
 Zooming ROXY Art-Z ■ 511
 Zooming ROXY S-Z ■ 512

DASH Smart Series

! NEW

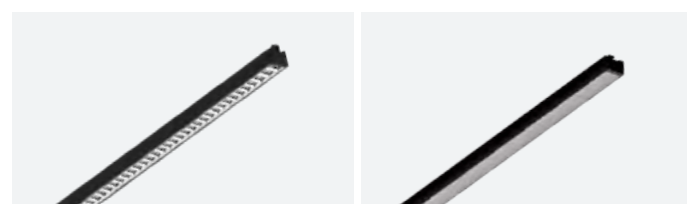

DSD26 ■ 519
 DS026 ■ 520

INLINE Series Tracklight



INLINE ST ■ 525
 INLINE SP ■ 526

INDEX

LED Strip Light **! NEW**



SL2835A
■ 533-534

SL2835B
■ 535-536

SL5050C
■ 537-538

SL2835D
■ 539-540

LED Neon Flex **! NEW**



NF1717T
■ 545-552

NF0817S
■ 553-558

NF1221S
■ 559-564

NF1228S
■ 565-572

SEAPOINT Series



SEAPOINT
■ 581-582

LAKEPOINT Series



LAKEPOINT Fixed
■ 583-584



LAKEPOINT Adjustable
■ 585-586

CARMEL Series



SKYSURFER SSRC
■ 587-588



CARMEL Round
■ 589-590

CLIFTON Series



CLIFTON
■ 591-592



RIVA Round
■ 593-594



RIVA Square
■ 595-596

CAMPSBAY Series



CAMPSBAY Single
■ 597-598



CAMPSBAY Double

LAGOON Series



LAGOON
■ 599-600

CRUZ D Series



CRUZ D
■ 601-602

CAPRI Series



CAPRI
■ 603-604

BAY Series



BAY
■ 605-606

NICE Series



NICE 250S & NICE 250D
■ 607-608

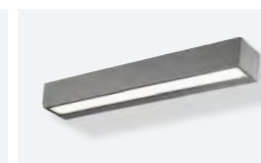

NICE 500S & NICE 500D
■ 609-610

St.Tropez Series



St.Tropez
■ 611-612

Capetown-Recessed Series

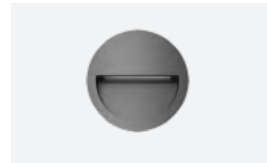

Capetown Round-Recessed
■ 613-614



Capetown Square-Recessed

Capetown-Surface Series

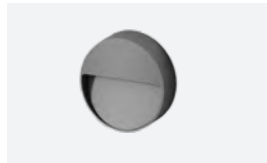

Capetown Round-Surface
■ 615-616



Capetown Square-Surface

POSEIDON Series

! NEW

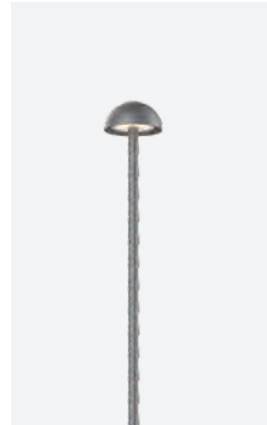

POSEIDON S100A
■ 617-620



POSEIDON S100B

CALIFORNIA Series



CALIFORNIA 12
■ 621-622

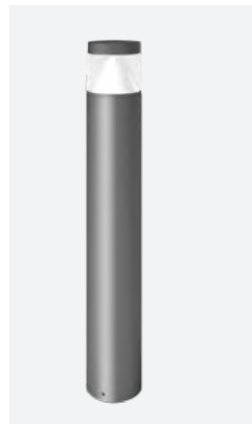

CALIFORNIA 16

DURBAN Series



DURBAN
■ 623-624

POSITANO Series

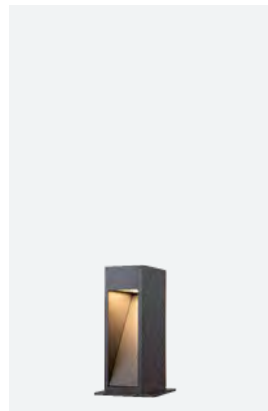

POSITANO 300
■ 625-626



POSITANO 600

PORTOFINO Series

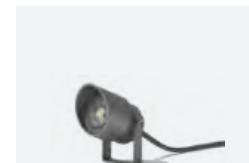

PORTOFINO S
■ 627-628



PORTOFINO L



PORTOFINO Adjustable

AFTER7 Series



AFTER7 Mini
■ 631



AFTER7 Maxi
■ 632

NEPTUNE Series

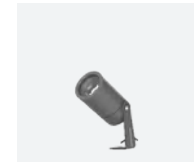

NEPTUNE XSU CV
■ 635

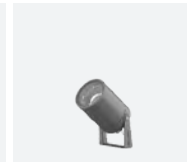

NEPTUNE SU CV
■ 636



NEPTUNE MU CV
■ 637



NEPTUNE LU CV
■ 638



NEPTUNE SR CV
NEPTUNE SR HV
■ 640



NEPTUNE MR CV
NEPTUNE MR HV
■ 641



NEPTUNE LR CV
NEPTUNE LR HV
■ 642

TERARACE Series

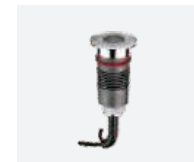

TERARACE Micro
■ 643



TERARACE Nano
■ 644



TERARACE Mini
■ 647



TERARACE Maxi
■ 648

MINUX

The
Slim
Powerful
Fixed Downlight



Minimalist slim design with high lumen package
Ceiling cut-outs in Ø38mm, Ø44mm and Ø57mm for trim version
Trimless versions also available (see details in following pages)
Aluminum housing and in wet-painting finish, excellent dissipation performance & antirust

Five different secondary reflectors of dark-light (chrome black), matt, white, black or gold
Beam angles in small, medium and wide for selection
UGR<19 providing visual comfort and quality light

LED chip in standard CRI>90 and 3-step MacAdam for perfect color consistency
Color temperature in 2700K, 3000K and 4000K as standard for selection
IP class in IP54 from front, good for damp applications

Different functions LED driver in On-Off, Phase Dim, 1-10V Dim and DALI Dim



37mm

Scale 1:1
millimeter





Trim Version



Trimless Version



EI-Trimless Version

MINUX 38 – The Slim & Powerful Fixed Downlight Series

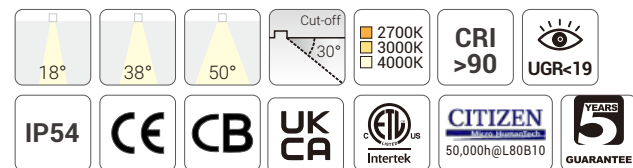

Quick Info

- Ceiling Cut-out: Ø38mm for Trim Version
- Trimless Version also Available
- CITIZEN LED: 6W, CRI>90
- CCT: 2700K, 3000K, 4000K Available as Standard
- Beam Angle: 18°(UGR<19), 38°(UGR<19), 50°
- Lumen Output: Up to 500lm System Luminous Flux
- IP Class: IP54 from Front
- LED Driver: On-Off, Phase Dim, 1-10V Dim, DALI Dim

Light Distribution

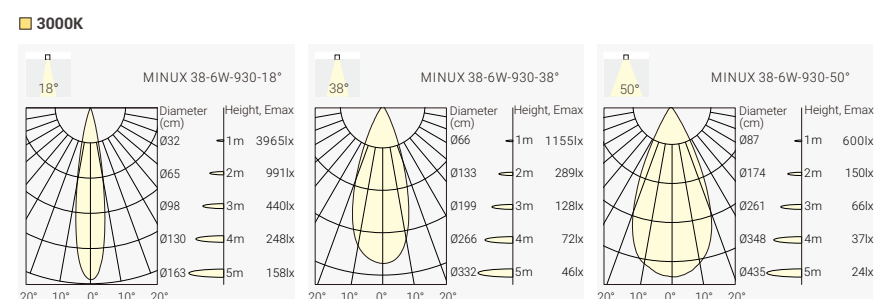

Order Info (MINUX 38 Trim Version in White Trim & Dark Light Reflector as an Example)

LED Power	System Power	LED Voltage	LED Current	CRI	CCT	Beam	LED Output	System Output	Code
6 W	8 W	12 V	500 mA	90	2700K	18°	500lm	420lm	MIF3-9271806N-WC
						38°	500lm	420lm	MIF3-9273806N-WC
						50°	500lm	420lm	MIF3-9275006N-WC
				3000K	18°	550lm	450lm	450lm	MIF3-9301806N-WC
					38°	550lm	450lm	450lm	MIF3-9303806N-WC
					50°	550lm	450lm	450lm	MIF3-9305006N-WC
				4000K	18°	600lm	500lm	500lm	MIF3-9401806N-WC
					38°	600lm	500lm	500lm	MIF3-9403806N-WC
					50°	600lm	500lm	500lm	MIF3-9405006N-WC

Code Remark: N=N(No Driver) F=F(ON-OFF) P=P(Phase Dim) A=A(1-10V Dim) D=D(DALI Dim)

Coding

Model	CRI/ CCT	Beam Angle	LED Power	Control	Trim Finish	Reflector Color	Accessory
MIF3	927	18	06	N	W	C	H
MINUX 38 Trim Version	CR190/ 2700K	18°	6W	No Driver	White	Dark Light	Honeycomb
MIT3	930	38		F	B	B	
MINUX 38 Trimless Version	CR190/ 3000K	38°		On-Off	Black	Black	
MIE3	940	50		P		M	
MINUX 38 EI-Trimless Version	CR190/ 4000K	50°		Phase Dim		Matt	
				A		W	
				1-10V Dim		White	
				D		G	
				DALI Dim		Gold	

Trim Finish



Reflector Options



Optional accessory

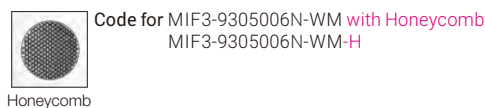

MINUX 44 – The Slim & Powerful Fixed Downlight Series

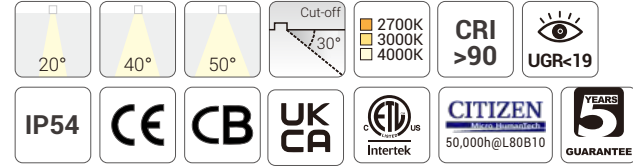
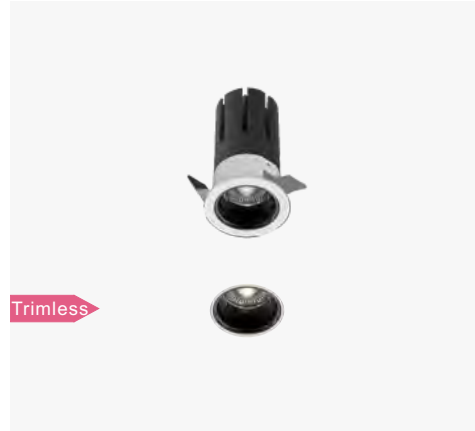

Quick Info

- Ceiling Cut-out: Ø44mm for Trim Version
- Trimless Version also Available
- CITIZEN LED: 9W, CRI>90
- CCT: 2700K, 3000K, 4000K Available as Standard
- Beam Angle: 20°(UGR<19), 40°(UGR<19), 50°
- Lumen Output: Up to 900lm System Luminous Flux
- IP Class: IP54 from Front
- LED Driver: On-Off, Phase Dim, 1-10V Dim, DALI Dim

Light Distribution

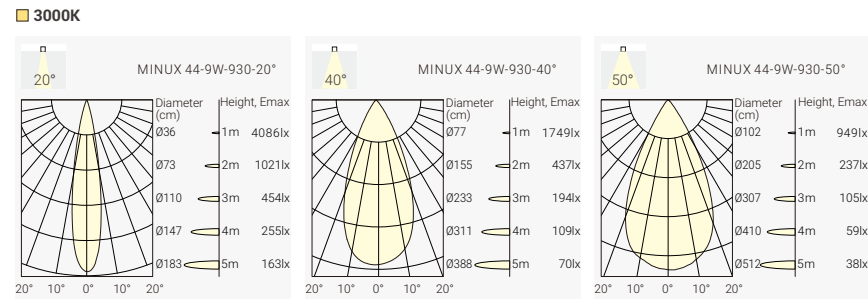

Order Info (MINUX 44 Trim Version in White Trim & Dark Light Reflector as an Example)

LED Power	System Power	LED Voltage	LED Current	CRI	CCT	Beam	LED Output	System Output	Code	
9 W	11 W	36 V	250 mA	90	2700K	20°	950lm	800lm	MIF4-9272009N-WC	
						40°	950lm	800lm	MIF4-9274009N-WC	
						50°	950lm	800lm	MIF4-9275009N-WC	
						3000K	20°	1000lm	850lm	MIF4-9302009N-WC
							40°	1000lm	850lm	MIF4-9304009N-WC
							50°	1000lm	850lm	MIF4-9305009N-WC
						4000K	20°	1050lm	900lm	MIF4-9402009N-WC
							40°	1050lm	900lm	MIF4-9404009N-WC
							50°	1050lm	900lm	MIF4-9405009N-WC

Code Remark: N=N(No Driver) F=F(ON-OFF) P=P(Phase Dim) A=A(1-10V Dim) D=D(DALI Dim)

Coding

Model	CRI/ CCT	Beam Angle	LED Power	Control	Trim Finish	Reflector Color	Accessory
MIF4	927	20	09	N	W	C	H
MINUX 44 Trim Version	CR190/ 2700K	20°	9W	No Driver	White	Dark Light	Honeycomb
MIT4	930	40		F	B	B	
MINUX 44 Trimless Version	CR190/ 3000K	40°		On-Off	Black	Black	
MIE4	940	50		P		M	
MINUX 44 EI-Trimless Version	CR190/ 4000K	50°		Phase Dim		Matt	
				A		W	
				1-10V Dim		White	
				D		G	
				DALI Dim		Gold	

Trim Finish



Reflector Options

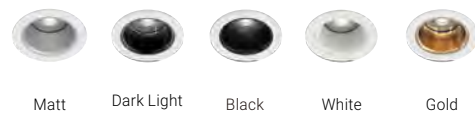

Optional accessory

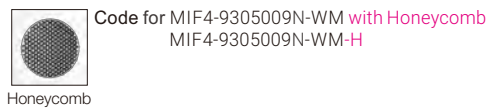

MINUX 57 – The Slim & Powerful Fixed Downlight Series

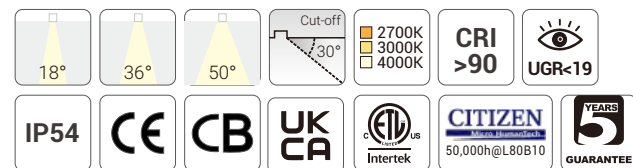

Quick Info

- Ceiling Cut-out: Ø57mm for Trim Version
- Trimless Version also Available
- CITIZEN LED: 13W, CRI>90
- CCT: 2700K, 3000K, 4000K Available as Standard
- Beam Angle: 18°(UGR<19), 36°(UGR<19), 50°
- Lumen Output: Up to 1050lm System Luminous Flux
- IP Class: IP54 from Front
- LED Driver: On-Off, Phase Dim, 1-10V Dim, DALI Dim, Casambi Wireless Dim

Light Distribution

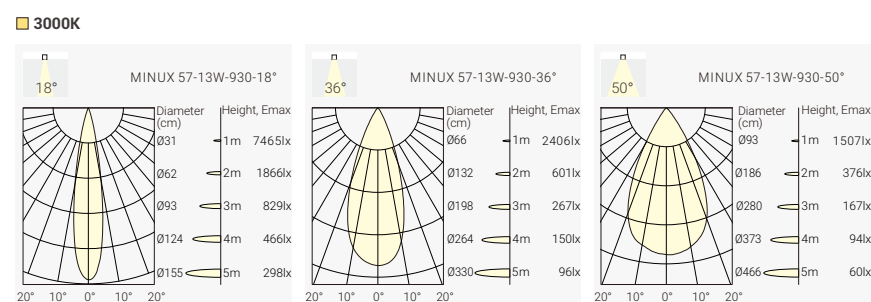

Order Info (MINUX 57 Trim Version in White Trim & Dark Light Reflector as an Example)

LED Power	System Power	LED Voltage	LED Current	CRI	CCT	Beam	LED Output	System Output	Code	
13 W	15 W	36 V	350 mA	90	2700K	18°	1200lm	950lm	MIF5-9271813N-WC	
						36°	1200lm	950lm	MIF5-9273613N-WC	
						50°	1200lm	950lm	MIF5-9275013N-WC	
						3000K	18°	1300lm	1000lm	MIF5-9301813N-WC
							36°	1300lm	1000lm	MIF5-9303613N-WC
							50°	1300lm	1000lm	MIF5-9305013N-WC
						4000K	18°	1400lm	1050lm	MIF5-9401813N-WC
							36°	1400lm	1050lm	MIF5-9403613N-WC
							50°	1400lm	1050lm	MIF5-9405013N-WC

Code Remark: N=N(No Driver) F=F(ON-OFF) P=P(Phase Dim) A=A(1-10V Dim) D=D(DALI Dim)

Coding

Model	CRI/ CCT	Beam Angle	LED Power	Control	Trim Finish	Reflector Color	Accessory
MIF5	927	18	13	N	W	C	H
MINUX 57 Trim Version	CR190/ 2700K	18°	13W	No Driver	White	Dark Light	Honeycomb
MIF5	930	36	13	F	B	B	
MINUX 57 Trimless Version	CR190/ 3000K	36°		On-Off	Black	Black	
MIF5	940	50	13	P		M	
MINUX 57 EI-Trimless Version	CR190/ 4000K	50°		Phase Dim		Matt	
				A		W	
				1-10V Dim		White	
				D		G	
				DALI Dim		Gold	

Trim Finish



Reflector Options

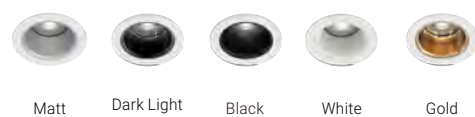

Optional accessory

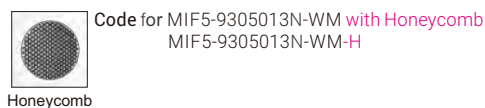

SENSE G2

The Upgraded SENSE Downlight Series
Modular Design Architectural Downlight System
Adjustable and Fixed
LED Engine Power from 4W to 38W
Round & Square, Trim & Trimless
Cutouts in 45mm, 55mm, 68mm, 75mm,
100mm, 125mm, 150mm





SENSE G2

Modular Design Architectural Downlight System

Adjustable and Fixed
LED Engine Power from 4W to 38W
Round & Square, Trim & Trimless
Cutouts in 45mm, 55mm, 68mm, 75mm, 100mm, 125mm, 150mm
Reflector Color in Dark-light(Chrome-black), Specular, Matt, White, Black & Gold

! NEW

! NEW



S45R1
4W 330lm-380lm

S55R1-G2
7W 460lm-600lm

S68R1-G2
7.5W 620lm-700lm
11W 770lm-850lm

S75R1-G2
11W 770lm-850lm

S100R1-G2
13W 1050lm-1300lm
18W 1400lm-1800lm

S100HR1-G2
25W 1800lm-2200lm

S125R1-G2
18W 1500lm-1900lm
25W 2000lm-2600lm

S150R1-G2
25W 2000lm-2700lm
38W 2800lm-3900lm

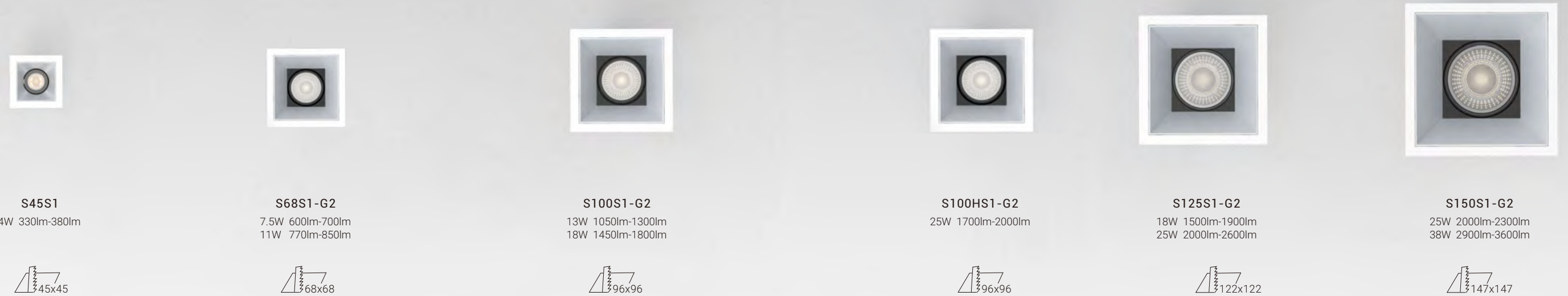

S45S1
4W 330lm-380lm

S68S1-G2
7.5W 600lm-700lm
11W 770lm-850lm

S100S1-G2
13W 1050lm-1300lm
18W 1450lm-1800lm

S100HS1-G2
25W 1700lm-2000lm

S125S1-G2
18W 1500lm-1900lm
25W 2000lm-2600lm

S150S1-G2
25W 2000lm-2300lm
38W 2900lm-3600lm



S100R2-G2
13W 950lm-1200lm
18W 1350lm-1700lm

S100HR2-G2
25W 1700lm-2000lm

S125R2-G2
18W 1400lm-1800lm
25W 1900lm-2400lm

S150R2-G2
25W 2100lm-2300lm
38W 2900lm-3400lm

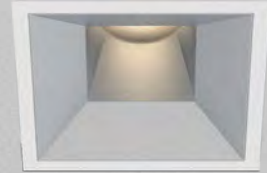
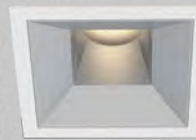

S100R7-G2
13W 850lm-1350lm
18W 1250lm-1900lm

S100HR7-G2
25W 1800lm-2200lm

S100S2-G2
13W 900lm-1150lm
18W 1200lm-1600lm

S100HS2-G2
25W 1400lm-1700lm

S125S2-G2
18W 1200lm-1700lm
25W 1700lm-2300lm

S150S2-G2
25W 1800lm-2200lm
38W 2500lm-3100lm

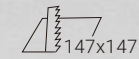
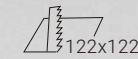
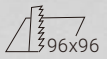
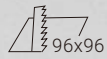

White

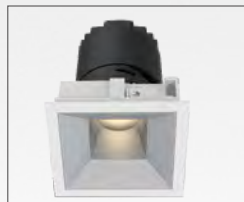

White



Black



Black



Project: Bellune Hotel Project, Paris, France



Project: Bellune Hotel Project, Paris, France



SENSE S45R1 – Modular design architectural downlight

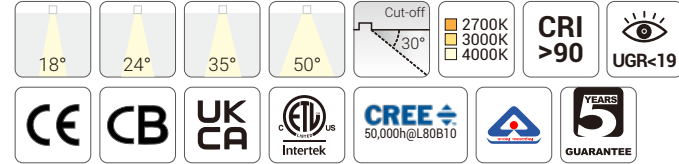

Quick Info

- Ceiling Cut-out: Ø45mm for Trim Version
- CREE LED: 4W, CRI>90
- CCT: 2700K, 3000K, 4000K Available as Standard
- Beam Angle: 18°, 24°, 35°, 50°
- Lumen Output: Up to 380lm System Luminous Flux
- IP Class: IP20
- LED Driver: On-Off, Phase Dim, 1-10V Dim, DALI Dim

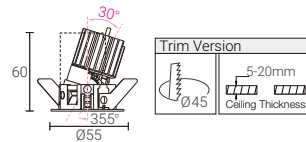

Light Distribution

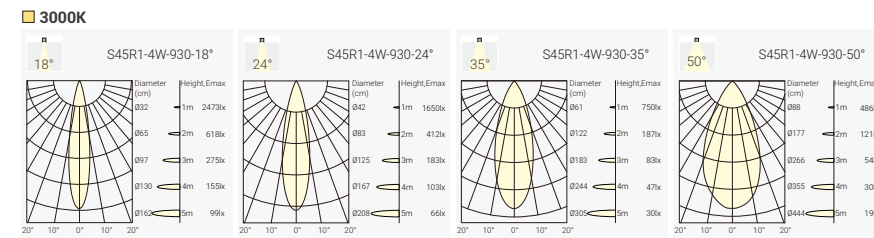

Order Info (SENSE S45 Trim Version in White Trim & Matt Reflector as an Example)

LED Power	System Power	LED Voltage	LED Current	CRI	CCT	Beam	LED Output	System Output	Code
4W	6W	12V	350mA	90	2700K	18°	480lm	330lm	SUR1-9271804N-WM
						24°	480lm	330lm	SUR1-9272404N-WM
						35°	480lm	330lm	SUR1-9273504N-WM
						50°	480lm	330lm	SUR1-9275004N-WM
				3000K	18°	500lm	350lm	350lm	SUR1-9303804N-WM
					24°	500lm	350lm	350lm	SUR1-9302404N-WM
					35°	500lm	350lm	350lm	SUR1-9303504N-WM
					50°	500lm	350lm	350lm	SUR1-9305004N-WM
				4000K	18°	550lm	380lm	380lm	SUR1-9401804N-WM
					24°	550lm	380lm	380lm	SUR1-9402404N-WM
					35°	550lm	380lm	380lm	SUR1-9403504N-WM
					50°	550lm	380lm	380lm	SUR1-9405004N-WM

Code Remark: N=N(No Driver) F=F(ON-OFF) P=P(Phase Dim) A=A(1-10V Dim) D=D(DALI Dim)

Trim Finish



Reflector Options



Optional accessory

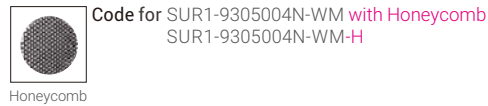

Coding

SUR1 - *** ** * - * * - *

Model	CRI/ CCT	Beam Angle	LED Power	Control	Trim Finish	Reflector Color	Accessory
SUR1	927	18	04	N	W	B	H
S45R1	CRI90/ 2700K	18°	4W	No Driver	White	Black	Honeycomb
	930	24		F	B	M	
	CRI90/ 3000K	24°		On-Off	Black	Matt	
	940	35		P		W	
	CRI90/ 4000K	35°		Phase Dim		White	
		50		A			
		50°		1-10V Dim			
				D			
				DALI Dim			



SENSE S45S1 – Modular design architectural downlight

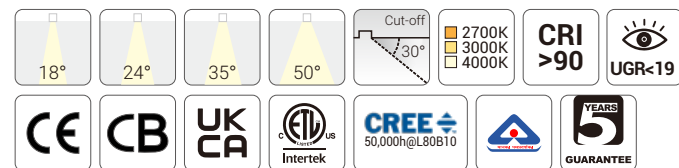

Quick Info

- Ceiling Cut-out: 45x45mm for Trim Version
- CREE LED: 4W, CRI>90
- CCT: 2700K, 3000K, 4000K Available as Standard
- Beam Angle: 18°, 24°, 35°, 50°
- Lumen Output: Up to 380lm System Luminous Flux
- IP Class: IP20
- LED Driver: On-Off, Phase Dim, 1-10V Dim, DALI Dim

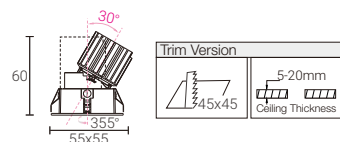

Light Distribution

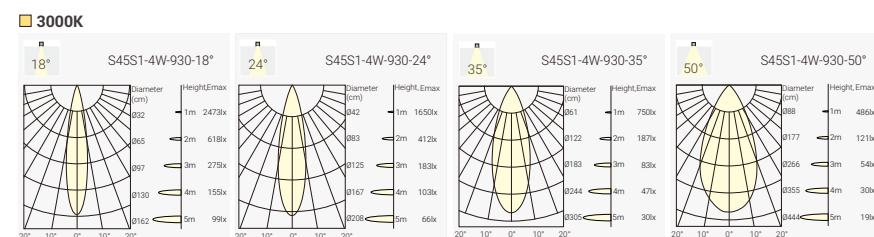

Order Info (SENSE S45 Trim Version in White Trim & Matt Reflector as an Example)

LED Power	System Power	LED Voltage	LED Current	CRI	CCT	Beam	LED Output	System Output	Code
4W	6W	12V	350mA	90	2700K	18°	480lm	330lm	SUS1-9271804N-WM
						24°	480lm	330lm	SUS1-9272404N-WM
						35°	480lm	330lm	SUS1-9273504N-WM
						50°	480lm	330lm	SUS1-9275004N-WM
				3000K		18°	500lm	350lm	SUS1-9303804N-WM
						24°	500lm	350lm	SUS1-9302404N-WM
						35°	500lm	350lm	SUS1-9303504N-WM
						50°	500lm	350lm	SUS1-9305004N-WM
				4000K		18°	550lm	380lm	SUS1-9401804N-WM
						24°	550lm	380lm	SUS1-9402404N-WM
						35°	550lm	380lm	SUS1-9403504N-WM
						50°	550lm	380lm	SUS1-9405004N-WM

Code Remark: N=N(No Driver) F=F(ON-OFF) P=P(Phase Dim) A=A(1-10V Dim) D=D(DALI Dim)

Trim Finish



White Black

Reflector Options



Black White Matt

Optional accessory



Honeycomb

Code for SUS1-9305004N-WM with Honeycomb
SUS1-9305004N-WM-H

Coding

SUS1 - *** ** * - * * - *

Model	CRI/ CCT	Beam Angle	LED Power	Control	Trim Finish	Reflector Color	Accessory
SUS1	927	18	04	N	W	B	H
S45S1	CRI90/ 2700K	18°	4W	No Driver	White	Black	Honeycomb
	930	24		F	B	M	
	CRI90/ 3000K	24°		On-Off	Black	Matt	
	940	35		P		W	
	CRI90/ 4000K	35°		Phase Dim		White	
		50		A			
		50°		1-10V Dim			
				D			
				DALI Dim			

Ultra Tiny



NEW



SENSE S55R1-G2 – The precise cut-off lighting performance adjustable downlight

NEW

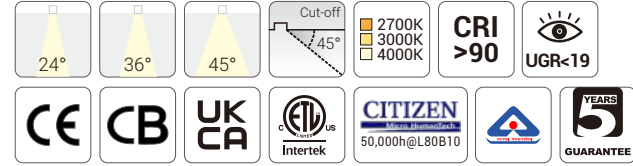

Quick Info

- The exceptionally precise cut-off lighting performance enhances the architectural lines on the wall, lending it a touch of elegance.
- Ceiling Cut-out: Ø55mm for Trim Version
- CITIZEN LED: 7W, CRI>90
- CCT: 2700K, 3000K, 4000K Available as Standard
- Beam Angle: 24°, 36°, 45°
- Lumen Output: Up to 600lm System Luminous Flux
- IP Class: IP20 (Light Engine IP54)
- LED Driver: On-Off, Phase Dim, 1-10V Dim, DALI Dim, Casambi Wireless Dim

Light Distribution

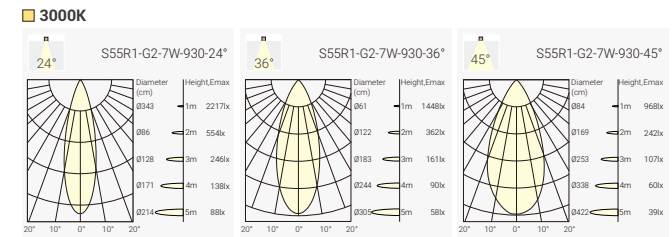

Order Info (SENSE S55R1-G2 Trim Version in White Trim & Black Reflector as an Example)

LED Power	System Power	LED Voltage	LED Current	CRI	CCT	Beam	LED Output	System Output	Code	
7W	8.5W	36V	200mA	90	2700K	24°	720lm	460lm	SXR1G2-9272407N-WB	
						36°	720lm	520lm	SXR1G2-9273607N-WB	
						45°	720lm	520lm	SXR1G2-9274507N-WB	
						3000K	24°	750lm	480lm	SXR1G2-9302407N-WB
							36°	750lm	550lm	SXR1G2-9303607N-WB
							45°	750lm	550lm	SXR1G2-9304507N-WB
						4000K	24°	800lm	530lm	SXR1G2-9402407N-WB
							36°	800lm	600lm	SXR1G2-9403607N-WB
							45°	800lm	600lm	SXR1G2-9404507N-WB

Code Remark: N=N(No Driver) F=F(ON-OFF) P=P(Phase Dim) A=A(1-10V Dim) D=D(DALI Dim)

Trim Finish



Reflector Options

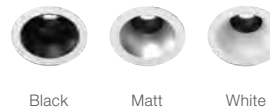

Optional accessory

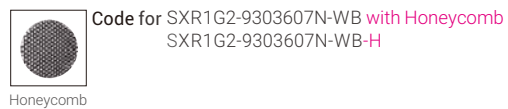

Coding

Model	CRI/ CCT	Beam Angle	LED Power	Control	Trim Finish	Reflector Color	Accessory
SXRG2	927	24	07	N	W	B	H
SENSE S55R1-G2 Trim Verion	CR190/ 2700K	24°	7W	No Driver	White	Black	Honeycomb
EXR1G2	930	36	7W	F	Black	M	
		36°		On-Off			
SENSE S55R1 EI-G2 EI-Trimless Verion	940	45	7W	P	White	W	
		45°		Phase Dim			
				A			
				1-10V Dim			
				D			
				DALI Dim			



Project Application Reference

SENSE G2 –Modular Design Architectural Downlight System

Project: MICHAEL KORS, Hongkong



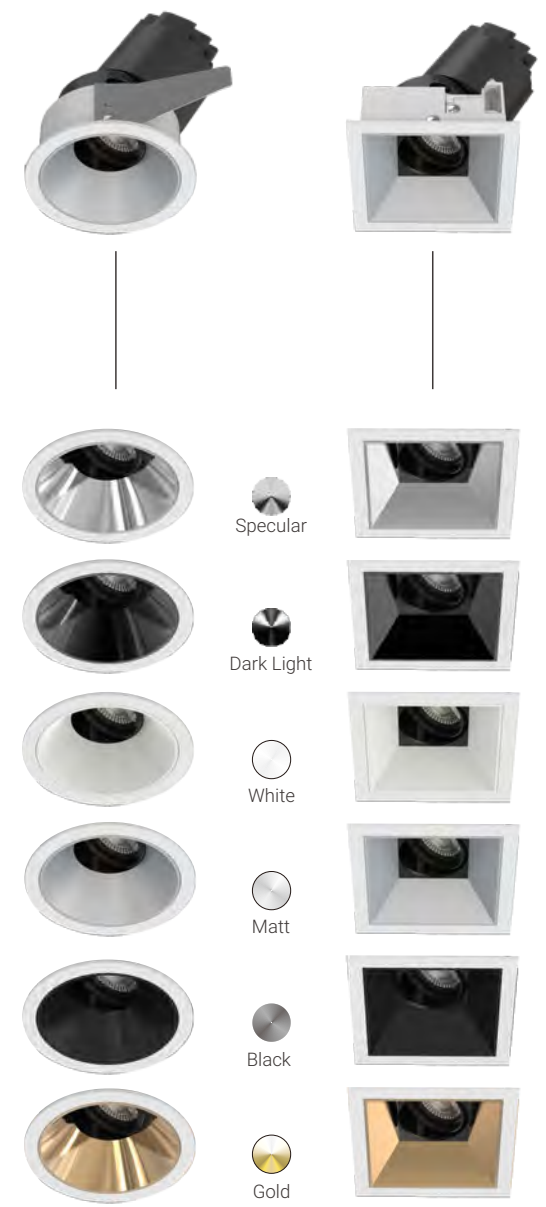

SENSE S68R1-G2 – Modular design architectural downlight

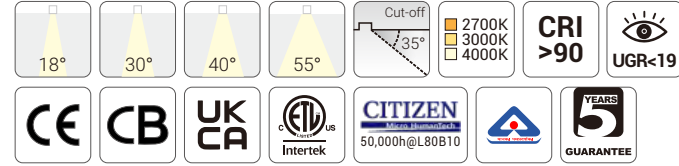

Quick Info

- Ceiling Cut-out: Ø68mm (Metal Ceiling: Ø70mm) for Trim Version
- Trimless Version also Available
- CITIZEN LED: 7.5W, 11W, CRI>90
- CCT: 2700K, 3000K, 4000K Available as Standard
- Beam Angle: 18°, 30°, 40°, 55°
- Lumen Output: Up to 850lm System Luminous Flux
- IP Class: IP20 (Light Engine IP54)
- LED Driver: On-Off, Phase Dim, 1-10V Dim, DALI Dim, Casambi Wireless Dim

Light Distribution

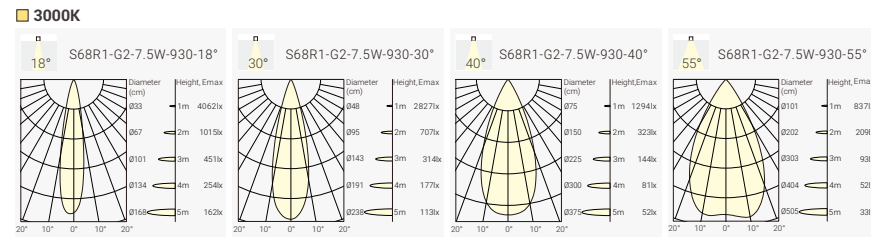

Order Info (SENSE 68-G2 Trim Version in White Trim & Dark Light Reflector as an Example)

LED Power	System Power	LED Voltage	LED Current	CRI	CCT	Beam	LED Output	System Output	Code	
7.5W	9W	31V	250mA	90	2700K	18°	850lm	620lm	STR1G2-9271808N-WC	
						30°	850lm	620lm	STR1G2-9273008N-WC	
						40°	850lm	620lm	STR1G2-9274008N-WC	
						55°	850lm	620lm	STR1G2-9275508N-WC	
						3000K	18°	900lm	650lm	STR1G2-9301808N-WC
							30°	900lm	650lm	STR1G2-9303008N-WC
							40°	900lm	650lm	STR1G2-9301408N-WC
							55°	900lm	650lm	STR1G2-9301558N-WC
						4000K	18°	1000lm	700lm	STR1G2-9401808N-WC
							30°	1000lm	700lm	STR1G2-9403008N-WC
							40°	1000lm	700lm	STR1G2-9404008N-WC
							55°	1000lm	700lm	STR1G2-9405508N-WC
11W	13W	31V	350mA	90	2700K	18°	1100lm	770lm	STR1G2-9271811N-WC	
						30°	1100lm	770lm	STR1G2-9273011N-WC	
						40°	1100lm	770lm	STR1G2-9274011N-WC	
						55°	1100lm	770lm	STR1G2-9275511N-WC	
						3000K	18°	1200lm	800lm	STR1G2-9301811N-WC
							30°	1200lm	800lm	STR1G2-9303011N-WC
							40°	1200lm	800lm	STR1G2-9301411N-WC
							55°	1200lm	800lm	STR1G2-9305511N-WC
						4000K	18°	1300lm	850lm	STR1G2-9401811N-WC
							30°	1300lm	850lm	STR1G2-9403011N-WC
							40°	1300lm	850lm	STR1G2-9404011N-WC
							55°	1300lm	850lm	STR1G2-9405511N-WC

Code Remark: N=N(No Driver) F=F(ON-OFF) P=P(Phase Dim) A=A(1-10V Dim) D=D(DALI Dim)

Coding

STR1G2 - *** ** * - * * - *

Model	CRI/ CCT	Beam Angle	LED Power	Control	Trim Finish	Reflector Color	Accessory
STR1G2 S68R1-G2 Trim Version	927 CRI90/ 2700K	18°	08 7.5W	N No Driver	W White	B Black	H Honeycomb
STR3G2 S68RT1-G2 Trimless Version	930 CRI90/ 3000K	30°	11 11W	F On-Off	B Black	M Matt	
ETR1G2 S68RT1-EI-G2 EI-Trimless Version	940 CRI90/ 4000K	40°		P Phase Dim		W White	
		55°		A 1-10V Dim		C Chrome Black	
				D DALI Dim		G Gold	
						S Specular	

Trim Finish



Reflector Options

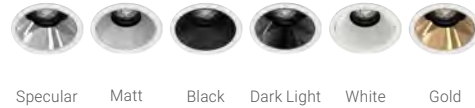

Optional accessory

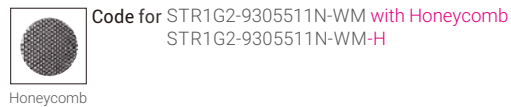

Light Distribution

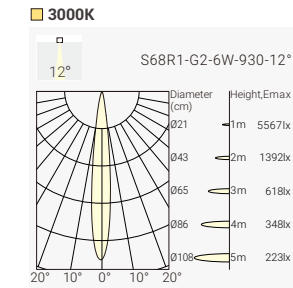

Order Info (SENSE 68-G2 Trim Version in White Trim & Dark Light Reflector as an Example)

LED Power	System Power	LED Voltage	LED Current	CRI	CCT	Beam	LED Output	System Output	Code
6W	8W	12V	500mA	90	2700K	12°	670lm	350m	STR1G2-9271206N-WC
						3000K	700lm	400lm	STR1G2-9301206N-WC
						4000K	750lm	450lm	STR1G2-9401206N-WC

Code Remark: N=N(No Driver) F=F(ON-OFF) P=P(Phase Dim) A=A(1-10V Dim) D=D(DALI Dim)

Coding

STR1G2 - *** ** * - * * - *

Model	CRI/ CCT	Beam Angle	LED Power	Control	Trim Finish	Reflector Color	Accessory
STR1G2 S68R1-G2 Trim Version	927 CRI90/ 2700K	12°	06 6W	N No Driver	W White	B Black	H Honeycomb
STR3G2 S68RT1-G2 Trimless Version	930 CRI90/ 3000K			F On-Off	B Black	M Matt	
ETR1G2 S68RT1-EI-G2 EI-Trimless Version	940 CRI90/ 4000K			P Phase Dim		W White	
				A 1-10V Dim		C Chrome Black	
				D DALI Dim		G Gold	
						S Specular	

SENSE S68S1-G2 – Modular design architectural downlight

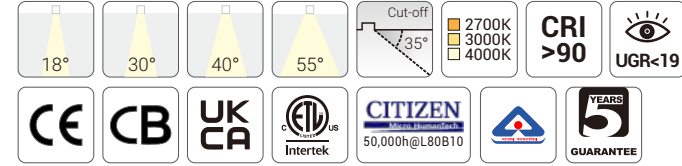

Quick Info

- Ceiling Cut-out: 68x68mm for Trim Version
- Trimless Version also Available
- CITIZEN LED: 7.5W/ 11W, CRI>90
- CCT: 2700K, 3000K, 4000K Available as Standard
- Beam Angle: 18°, 30°, 40°, 55°
- Lumen Output: Up to 850lm System Luminous Flux
- IP Class: IP20 (Light Engine IP54)
- LED Driver: On-Off, Phase Dim, 1-10V Dim, DALI Dim, Casambi Wireless Dim

Light Distribution

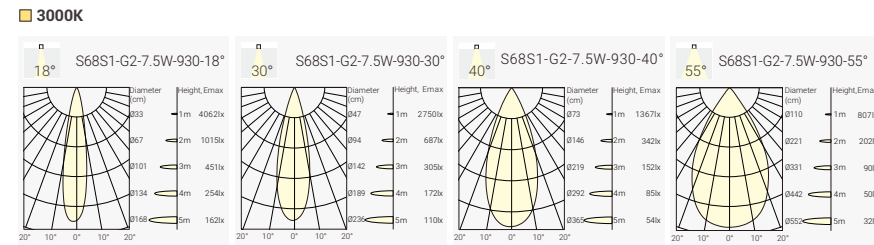

Order Info (SENSE 68-G2 Trim Version in White Trim & Dark Light Reflector as an Example)

LED Power	System Power	LED Voltage	LED Current	CRI	CCT	Beam	LED Output	System Output	Code	
7.5W	9W	31V	250mA	90	2700K	18°	850lm	620lm	STS1G2-9271808N-WC	
						30°	850lm	620lm	STS1G2-9273008N-WC	
						40°	850lm	620lm	STS1G2-9274008N-WC	
						55°	850lm	620lm	STS1G2-9275508N-WC	
						3000K	18°	900lm	650lm	STS1G2-9301808N-WC
							30°	900lm	650lm	STS1G2-9303008N-WC
							40°	900lm	650lm	STS1G2-9301408N-WC
							55°	900lm	650lm	STS1G2-9301558N-WC
						4000K	18°	1000lm	700lm	STS1G2-9401808N-WC
							30°	1000lm	700lm	STS1G2-9403008N-WC
							40°	1000lm	700lm	STS1G2-9404008N-WC
							55°	1000lm	700lm	STS1G2-9405508N-WC
11W	13W	31V	350mA	90	2700K	18°	1100lm	770lm	STS1G2-9271811N-WC	
						30°	1100lm	770lm	STS1G2-9273011N-WC	
						40°	1100lm	770lm	STS1G2-9274011N-WC	
						55°	1100lm	770lm	STS1G2-9275511N-WC	
						3000K	18°	1200lm	800lm	STS1G2-9301811N-WC
							30°	1200lm	800lm	STS1G2-9303011N-WC
							40°	1200lm	800lm	STS1G2-9301411N-WC
							55°	1200lm	800lm	STS1G2-9305511N-WC
						4000K	18°	1300lm	850lm	STS1G2-9401811N-WC
							30°	1300lm	850lm	STS1G2-9403011N-WC
							40°	1300lm	850lm	STS1G2-9404011N-WC
							55°	1300lm	850lm	STS1G2-9405511N-WC

Code Remark: N=N(No Driver) F=F(ON-OFF) P=P(Phase Dim) A=A(1-10V Dim) D=D(DALI Dim)

Coding

STS1G2 - *** ** * - * * - *

Model	CRI/ CCT	Beam Angle	LED Power	Control	Trim Finish	Reflector Color	Accessory
STS1G2 S68S1-G2 Trim Version	927 CRI90/ 2700K	18°	08 7.5W	N No Driver	W White	B Black	H Honeycomb
STS3G2 S68S1-G2 Trimless Version	930 CRI90/ 3000K	30°	11 11W	F On-Off	B Black	M Matt	
ETS1G2 S68S1-EI-G2 EI-Trimless Version	940 CRI90/ 4000K	40°		P Phase Dim	W White		
		55°		A 1-10V Dim	C Chrome Black		
				D DALI Dim	G Gold		
					S Specular		

Trim Finish



White Black

Reflector Options



Specular Matt Black Dark Light White Gold

Optional accessory



Honeycomb

Code for STS1G2-9304004N-WM with Honeycomb
STS1G2-9304004N-WM-H

Light Distribution

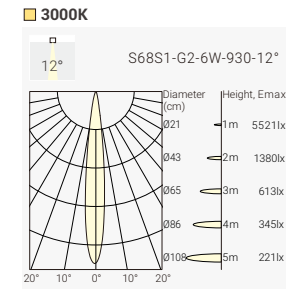

Order Info (SENSE 68-G2 Trim Version in White Trim & Dark Light Reflector as an Example)

LED Power	System Power	LED Voltage	LED Current	CRI	CCT	Beam	LED Output	System Output	Code
6W	8W	12V	500mA	90	2700K	12°	670lm	350m	STS1G2-9271206N-WC
						3000K	12°	700lm	400lm
					4000K	12°	750lm	450lm	STS1G2-9401206N-WC

Code Remark: N=N(No Driver) F=F(ON-OFF) P=P(Phase Dim) A=A(1-10V Dim) D=D(DALI Dim)

Coding

STS1G2 - *** ** * - * * - *

Model	CRI/ CCT	Beam Angle	LED Power	Control	Trim Finish	Reflector Color	Accessory
STS1G2 S68S1-G2 Trim Version	927 CRI90/ 2700K	12°	06 6W	N No Driver	W White	B Black	H Honeycomb
STS3G2 S68S1-G2 Trimless Version	930 CRI90/ 3000K			F On-Off	B Black	M Matt	
ETS1G2 S68S1-EI-G2 EI-Trimless Version	940 CRI90/ 4000K			P Phase Dim	W White		
				A 1-10V Dim	C Chrome Black		
				D DALI Dim	G Gold		
					S Specular		

SENSE S75R1-G2 – The precise cut-off lighting performance adjustable downlight

NEW

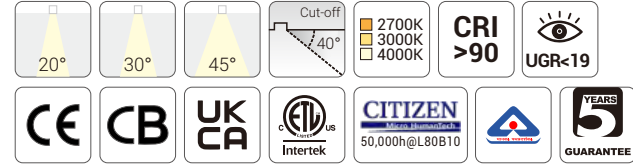

Quick Info

- The exceptionally precise cut-off lighting performance enhances the architectural lines on the wall, lending it a touch of elegance.
- Ceiling Cut-out: Ø75mm for Trim Version
- CITIZEN LED: 11W, CRI>90
- CCT: 2700K, 3000K, 4000K Available as Standard
- Beam Angle: 20°, 30°, 45°
- Lumen Output: Up to 850lm System Luminous Flux
- IP Class: IP20 (Light Engine IP54)
- LED Driver: On-Off, Phase Dim, 1-10V Dim, DALI Dim, Casambi Wireless Dim

Light Distribution

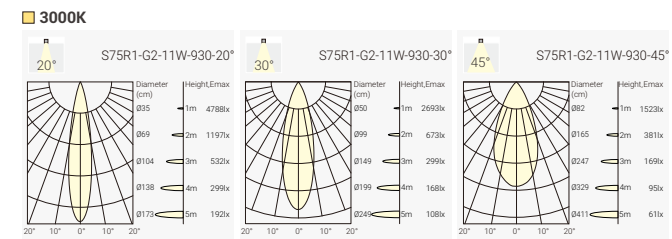

Order Info (SENSE S75R1-G2 Trim Version in White Trim & Black Reflector as an Example)

LED Power	System Power	LED Voltage	LED Current	CRI	CCT	Beam	LED Output	System Output	Code	
11W	13W	31V	350mA	90	2700K	20°	900lm	770lm	SGR1G2-9272011N-WB	
						30°	900lm	770lm	SGR1G2-9273011N-WB	
						45°	900lm	770lm	SGR1G2-9274511N-WB	
						3000K	20°	950lm	800lm	SGR1G2-9302011N-WB
							30°	950lm	800lm	SGR1G2-9303011N-WB
							45°	950lm	800lm	SGR1G2-9304511N-WB
						4000K	20°	1000lm	850lm	SGR1G2-9402011N-WB
							30°	1000lm	850lm	SGR1G2-9403011N-WB
							45°	1000lm	850lm	SGR1G2-9404511N-WB

Code Remark: N=N(No Driver) F=F(ON-OFF) P=P(Phase Dim) A=A(1-10V Dim) D=D(DALI Dim)

Trim Finish



Reflector Options



Optional accessory

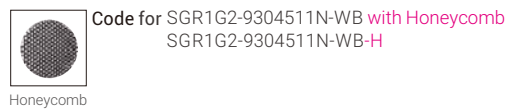

Coding

Model	CRI/ CCT	Beam Angle	LED Power	Control	Trim Finish	Reflector Color	Accessory
SGR1G2	927	20	11	N	W	B	H
SENSE S75R1-G2 Trim Verion	CR190/ 2700K	20°	11W	No Driver	White	Black	Honeycomb
EGR1G2	930	30		F	B	M	
SENSE S75R1 EI-G2 EI-Trimless Verion	CR190/ 3000K	30°		On-Off	Black	Matt	
	940	45		P		W	
	CR190/ 4000K	45°		Phase Dim		White	
				A			
				1-10V Dim			
				D			
				DALI Dim			



Project: Application Reference

SENSE G2 –Modular Design Architectural Downlight System

Project: Mist Hot Spring Hotel Xuchang, China



SENSE G2 –Modular Design Architectural Downlight System

Project: Holiday Inn Pattaya, Thailand





S100G2 LED Engine
Adjustable/ Fixed



S100HG2 LED Engine
Adjustable/ Fixed

Trim



Round Trim



Round Trimless



Round EI-Trimless



Square Trim



Square Trimless

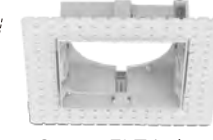

Square EI-Trimless

Accessory



Honeycomb



Linear Spread Filter



Diffusion Filter



Honeycomb



Linear Spread Filter



Diffusion Filter

Reflector



Round Adjustable



Round Fixed
(Horn Type)



Round Fixed



Square Adjustable



Square Fixed

Anti-Glare Ring



(Straight Type)



(Curve Type, Option)



(Straight Type)



(Curve Type, Option)

Second Accessory



(Option)



(Option)

Model



S100R1-G2



S100R1-G2-CA



S100R7-G2



S100R2-G2



S100S1-G2



S100S1-G2-CA



S100S2-G2

Secondary Reflector



Specular



Dark Light



Matt



White



Black



Gold

SENSE S100R1-G2 – Modular design architectural downlight

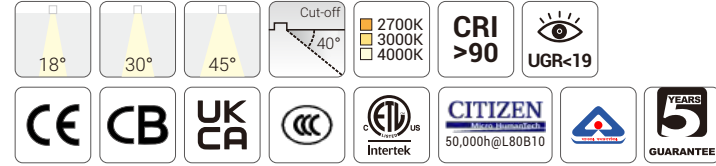

Quick Info

- Ceiling Cut-out: Ø100mm for Trim Version
- Trimless Version also Available
- CITIZEN LED: 13W, 18W, CRI>90
- CCT: 2700K, 3000K, 4000K Available as Standard
- Beam Angle: 18°, 30°, 45°
- Lumen Output: Up to 1800lm System Luminous Flux
- IP Class: IP20 (Light Engine IP54)
- LED Driver: On-Off, Phase Dim, 1-10V Dim, DALI Dim, Casambi Wireless Dim

Light Distribution

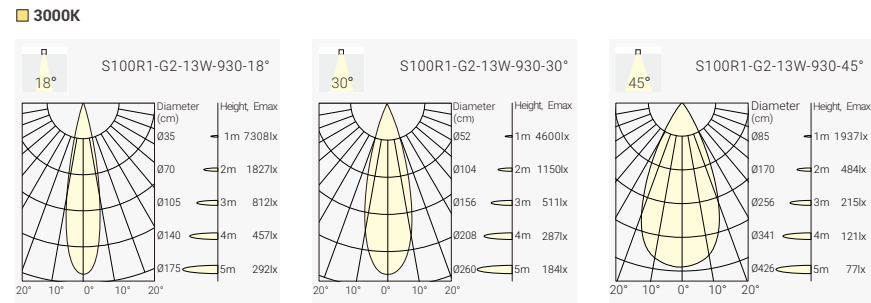

Order Info (SENSE 100-G2 Trim Version in White Trim & Dark Light Reflector as an Example)

LED Power	System Power	LED Voltage	LED Current	CRI	CCT	Beam	LED Output	System Output	Code						
13W	15W	36V	350mA	90	2700K	18°	1500lm	1050lm	SSR1G2-9271813N-WC						
						30°	1500lm	1100lm	SSR1G2-9273013N-WC						
						45°	1500lm	1050lm	SSR1G2-9274513N-WC						
						3000K	18°	1600lm	1150lm	SSR1G2-9301813N-WC					
							30°	1600lm	1200lm	SSR1G2-9303013N-WC					
							45°	1600lm	1150lm	SSR1G2-9304513N-WC					
						4000K	18°	1700lm	1200lm	SSR1G2-9401813N-WC					
							30°	1700lm	1300lm	SSR1G2-9403013N-WC					
							45°	1700lm	1200lm	SSR1G2-9404513N-WC					
						18W	21W	36V	500mA	90	2700K	18°	1900lm	1400lm	SSR1G2-9271818N-WC
												30°	1900lm	1600lm	SSR1G2-9273018N-WC
												45°	1900lm	1400lm	SSR1G2-9274518N-WC
3000K	18°	2000lm	1500lm	SSR1G2-9301818N-WC											
	30°	2000lm	1700lm	SSR1G2-9303018N-WC											
	45°	2000lm	1500lm	SSR1G2-9304518N-WC											
4000K	18°	2200lm	1700lm	SSR1G2-9401818N-WC											
	30°	2200lm	1800lm	SSR1G2-9403018N-WC											
	45°	2200lm	1700lm	SSR1G2-9404518N-WC											

Code Remark: N=N(No Driver) F=F(ON-OFF) P=P(Phase Dim) A=A(1-10V Dim) D=D(DALI Dim)

Coding

Model	CRI/ CCT	Beam Angle	LED Power	Control	Trim Finish	Reflector Color	Accessory
SSR1G2	927	18	13	N	W	B	H
SENSE 100-G2 Trim Verion	CR190/ 2700K	18°	13W	No Driver	White	Black	Honeycomb
SSR4G2	930	30	18	F	B	M	
SENSE 100-G2 Trimless Verion	CR190/ 3000K	36°	18W	On-Off	Black	Matt	
ESR1G2	940	45		P		W	
SENSE 100-G2 EI-Trimless Verion	CR190/ 4000K	45°		Phase Dim		White	
				A		C	
				1-10V Dim		Dark Light	
				D		G	
				DALI Dim		Gold	
						S	
						Specular	

Trim Finish



White Black

Reflector Options



Specular Matt Black Dark Light White Gold

Optional accessory



Honeycomb

Code for SSR1G2-9304018N-WM with Honeycomb
SSR1G2-9304018N-WM-H

Light Distribution

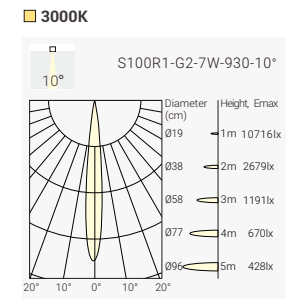

Order Info (SENSE 100-G2 Trim Version in White Trim & Dark Light Reflector as an Example)

LED Power	System Power	LED Voltage	LED Current	CRI	CCT	Beam	LED Output	System Output	Code
7W	9W	36V	200mA	90	2700K	10°	600lm	480lm	SSR1G2-9271007N-WC
					3000K	10°	650lm	500lm	SSR1G2-9301007N-WC
					4000K	10°	700lm	550lm	SSR1G2-9401007N-WC

Code Remark: N=N(No Driver) F=F(ON-OFF) P=P(Phase Dim) A=A(1-10V Dim) D=D(DALI Dim)

Coding

Model	CRI/ CCT	Beam Angle	LED Power	Control	Trim Finish	Reflector Color	Accessory
SSR1G2	927	10	07	N	W	B	H
SENSE 100-G2 Trim Verion	CR190/ 2700K	10°	7W	No Driver	White	Black	Honeycomb
SSR4G2	930			F	B	M	
SENSE 100-G2 Trimless Verion	CR190/ 3000K			On-Off	Black	Matt	
ESR1G2	940			P		W	
SENSE 100-G2 EI-Trimless Verion	CR190/ 4000K			Phase Dim		White	
				A		C	
				1-10V Dim		Dark Light	
				D		G	
				DALI Dim		Gold	
						S	
						Specular	

SENSE S100S1-G2 – Modular design architectural downlight

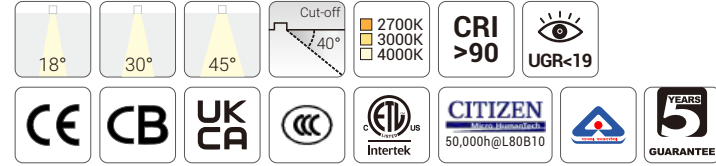

Quick Info

- Ceiling Cut-out: 96x96mm for Trim Version
- Trimless Version also Available
- CITIZEN LED: 13W, 18W, CRI>90
- CCT: 2700K, 3000K, 4000K Available as Standard
- Beam Angle: 18°, 30°, 45°
- Lumen Output: Up to 1800lm System Luminous Flux
- IP Class: IP20 (Light Engine IP54)
- LED Driver: On-Off, Phase Dim, 1-10V Dim, DALI Dim, Casambi Wireless Dim

Light Distribution

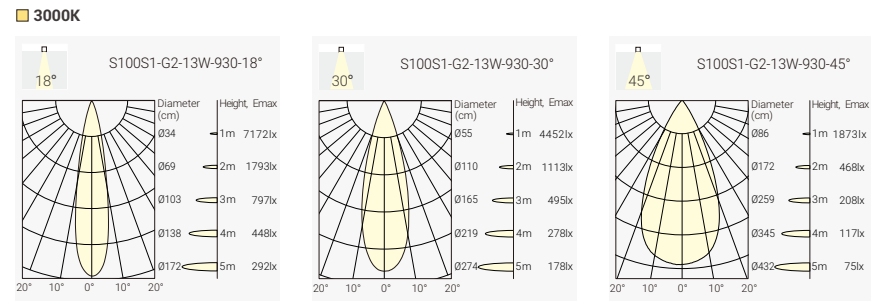

Order Info (SENSE 100-G2 Trim Version in White Trim & Dark Light Reflector as an Example)

LED Power	System Power	LED Voltage	LED Current	CRI	CCT	Beam	LED Output	System Output	Code						
13W	15W	36V	350mA	90	2700K	18°	1500lm	1050lm	SSS1G2-9271813N-WC						
						30°	1500lm	1150lm	SSS1G2-9273013N-WC						
						45°	1500lm	1050lm	SSS1G2-9274513N-WC						
						3000K	18°	1600lm	1150lm	SSS1G2-9301813N-WC					
							30°	1600lm	1250lm	SSS1G2-9303013N-WC					
							45°	1600lm	1150lm	SSS1G2-9304513N-WC					
						4000K	18°	1700lm	1200lm	SSS1G2-9401813N-WC					
							30°	1700lm	1300lm	SSS1G2-9403013N-WC					
							45°	1700lm	1200lm	SSS1G2-9404513N-WC					
						18W	21W	36V	500mA	90	2700K	18°	1900lm	1450lm	SSS1G2-9271818N-WC
												30°	1900lm	1550lm	SSS1G2-9273018N-WC
												45°	1900lm	1450lm	SSS1G2-9274518N-WC
3000K	18°	2000lm	1550lm	SSS1G2-9301818N-WC											
	30°	2000lm	1650lm	SSS1G2-9303018N-WC											
	45°	2000lm	1550lm	SSS1G2-9304518N-WC											
4000K	18°	2200lm	1600lm	SSS1G2-9401818N-WC											
	30°	2200lm	1800lm	SSS1G2-9403018N-WC											
	45°	2200lm	1600lm	SSS1G2-9404518N-WC											

Code Remark: N=N(No Driver) F=F(ON-OFF) P=P(Phase Dim) A=A(1-10V Dim) D=D(DALI Dim)

Coding

Model	CRI/ CCT	Beam Angle	LED Power	Control	Trim Finish	Reflector Color	Accessory
SSS1G2	927	18	13	N	W	B	H
SENSE 100-G2 Trim Verion	CR190/ 2700K	18°	13W	No Driver	White	Black	Honeycomb
SSS4G2	930	30	18	F	B	M	
SENSE 100-G2 Trimless Verion	CR190/ 3000K	30°	18W	On-Off	Black	Matt	
ESS1G2	940	45		P		W	
SENSE 100-G2 EI-Trimless Verion	CR190/ 4000K	45°		Phase Dim		White	
				A		C	
				1-10V Dim		Dark Light	
				D		G	
				DALI Dim		Gold	
						S	
						Specular	

Trim Finish



White Black

Reflector Options



Specular Matt Black Dark Light White Gold

Optional accessory



Honeycomb

Code for SSS1G2-9301813N-WM with Honeycomb
SSS1G2-9301813N-WM-H

Light Distribution

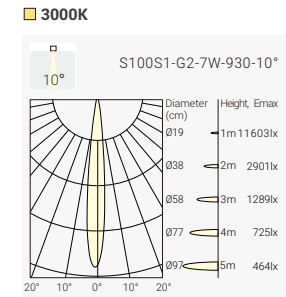

Order Info (SENSE 100-G2 Trim Version in White Trim & Dark Light Reflector as an Example)

LED Power	System Power	LED Voltage	LED Current	CRI	CCT	Beam	LED Output	System Output	Code
7W	9W	36V	200mA	90	2700K	10°	600lm	480lm	SSS1G2-9271007N-WC
					3000K	10°	650lm	500lm	SSS1G2-9301007N-WC
					4000K	10°	700lm	550lm	SSS1G2-9401007N-WC

Code Remark: N=N(No Driver) F=F(ON-OFF) P=P(Phase Dim) A=A(1-10V Dim) D=D(DALI Dim)

Coding

Model	CRI/ CCT	Beam Angle	LED Power	Control	Trim Finish	Reflector Color	Accessory
SSS1G2	927	10	07	N	W	B	H
SENSE 100-G2 Trim Verion	CR190/ 2700K	10°	7W	No Driver	White	Black	Honeycomb
SSS4G2	930			F	B	M	
SENSE 100-G2 Trimless Verion	CR190/ 3000K			On-Off	Black	Matt	
ESS1G2	940			P		W	
SENSE 100-G2 EI-Trimless Verion	CR190/ 4000K			Phase Dim		White	
				A		C	
				1-10V Dim		Dark Light	
				D		G	
				DALI Dim		Gold	
						S	
						Specular	

SENSE S100HR1-G2 – Modular design architectural downlight

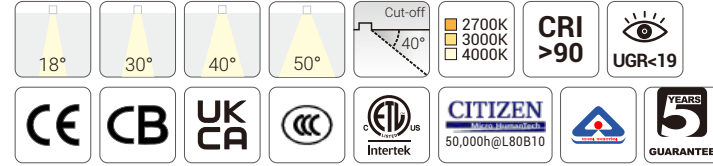

Quick Info

- Ceiling Cut-out: Ø100mm for Trim Version
- Trimless Version also Available
- CITIZEN LED: 25W, CRI>90
- CCT: 2700K, 3000K, 4000K Available as Standard
- Beam Angle: 18°, 30°, 40°, 50°
- Lumen Output: Up to 2200lm System Luminous Flux
- IP Class: IP20 (Light Engine IP54)
- LED Driver: On-Off, Phase Dim, 1-10V Dim, DALI Dim, Casambi Wireless Dim

Light Distribution

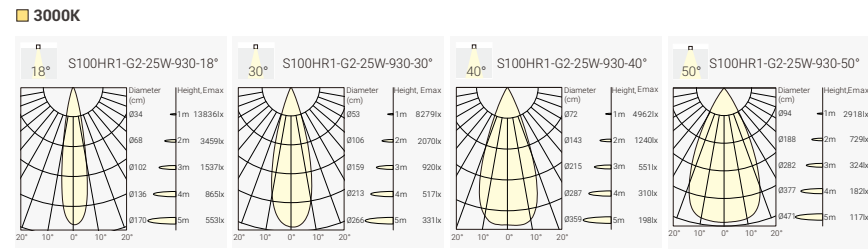

Order Info (SENSE 100H-G2 Trim Version in White Trim & Dark Light Reflector as an Example)

LED Power	System Power	LED Voltage	LED Current	CRI	CCT	Beam	LED Output	System Output	Code	
25W	28W	36V	700mA	90	2700K	18°	2400lm	1900lm	SHR1G2-9271825N-WC	
						30°	2400lm	2000lm	SHR1G2-9273025N-WC	
						40°	2400lm	2000lm	SHR1G2-9274025N-WC	
						50°	2400lm	1800lm	SHR1G2-9275025N-WC	
						3000K	18°	2600lm	2000lm	SHR1G2-9301825N-WC
							30°	2600lm	2100lm	SHR1G2-9303025N-WC
							40°	2600lm	2100lm	SHR1G2-9304025N-WC
							50°	2600lm	1900lm	SHR1G2-9305025N-WC
						4000K	18°	2800lm	2100lm	SHR1G2-9401825N-WC
							30°	2800lm	2200lm	SHR1G2-9403025N-WC
							40°	2800lm	2200lm	SHR1G2-9404025N-WC
							50°	2800lm	2000lm	SHR1G2-9405025N-WC

Code Remark: N=N(No Driver) F=F(ON-OFF) P=P(Phase Dim) A=A(1-10V Dim) D=D(DALI Dim)

Coding

SHR1G2 - *** ** ** * - * * - *

Model	CRI/ CCT	Beam Angle	LED Power	Control	Trim Finish	Reflector Color	Accessory
SHR1G2	927	18°	25	N	W	B	H
SENSE 100H-G2 Trim Verion	CR190/ 2700K	18°	25W	No Driver	White	Black	Honeycomb
SHR4G2	930	30°		F	B	M	
SENSE 100H-G2 Trimless Verion	CR190/ 3000K	30°		On-Off	Black	Matt	
EHR1G2	940	40°		P	W	W	
SENSE 100H-G2 EI-Trimless Verion	CR190/ 4000K	40°		Phase Dim	White	White	
		50°		A	C	C	
		50°		1-10V Dim	Dark Light	Dark Light	
				D	G	G	
				DALI Dim	Gold	Gold	
					S	S	
					Specular	Specular	

Trim Finish



White Black

Reflector Options



Specular Matt Black Dark Light White Gold

Optional accessory



Honeycomb

Code for SHR1G2-9304025N-WM with Honeycomb
SHR1G2-9304025N-WM-H

SENSE S100HS1-G2 – Modular design architectural downlight

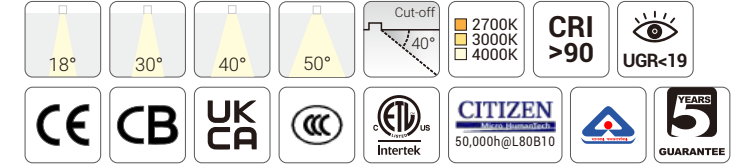

Quick Info

- Ceiling Cut-out: 96x96mm for Trim Version
- Trimless Version also Available
- CITIZEN LED: 25W, CRI>90, CITIZEN
- CCT: 2700K, 3000K, 4000K Available as Standard
- Beam Angle: 18°, 30°, 40°, 50°
- Lumen Output: Up to 2000lm System Luminous Flux
- IP Class: IP20 (Light Engine IP54)
- LED Driver: On-Off, Phase Dim, 1-10V Dim, DALI Dim, Casambi Wireless Dim

Light Distribution

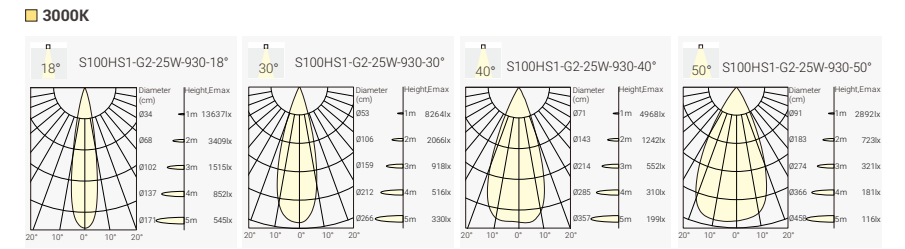

Order Info (SENSE 100H-G2 Trim Version in White Trim & Dark Light Reflector as an Example)

LED Power	System Power	LED Voltage	LED Current	CRI	CCT	Beam	LED Output	System Output	Code	
25W	28W	36V	700mA	90	2700K	18°	2400lm	1700lm	SHS1G2-9271825N-WC	
						30°	2400lm	1800lm	SHS1G2-9273025N-WC	
						40°	2400lm	1800lm	SHS1G2-9274025N-WC	
						50°	2400lm	1700lm	SHS1G2-9275025N-WC	
						3000K	18°	2600lm	1800lm	SHS1G2-9301825N-WC
							30°	2600lm	1900lm	SHS1G2-9303025N-WC
							40°	2600lm	1900lm	SHS1G2-9304025N-WC
							50°	2600lm	1800lm	SHS1G2-9305025N-WC
						4000K	18°	2800lm	1900lm	SHS1G2-9401825N-WC
							30°	2800lm	2000lm	SHS1G2-9403025N-WC
							40°	2800lm	2000lm	SHS1G2-9404025N-WC
							50°	2800lm	1900lm	SHS1G2-9405025N-WC

Code Remark: N=N(No Driver) F=F(ON-OFF) P=P(Phase Dim) A=A(1-10V Dim) D=D(DALI Dim)

Trim Finish



White Black

Reflector Options



Specular Matt Black Dark Light White Gold

Optional accessory



Honeycomb

Code for SHS1G2-9301825N-WM with Honeycomb
SHS1G2-9301825N-WM-H

Coding

SHS1G2 - *** ** ** * - * * - *

Model	CRI/ CCT	Beam Angle	LED Power	Control	Trim Finish	Reflector Color	Accessory
SHS1G2	927	18°	25	N	W	B	H
SENSE 100H-G2 Trim Verion	CR190/ 2700K	18°	25W	No Driver	White	Black	Honeycomb
SHS4G2	930	30°		F	B	M	
SENSE 100H-G2 Trimless Verion	CR190/ 3000K	30°		On-Off	Black	Matt	
EHS1G2	940	40°		P	W	W	
SENSE 100H-G2 EI-Trimless Verion	CR190/ 4000K	40°		Phase Dim	White	White	
		50°		A	C	C	
		50°		1-10V Dim	Dark Light	Dark Light	
				D	G	G	
				DALI Dim	Gold	Gold	
					S	S	
					Specular	Specular	

SENSE S100R7-G2 – Modular design architectural downlight

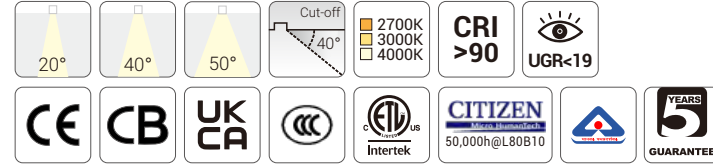

Quick Info

- Ceiling Cut-out: Ø100mm for Trim Version
- Trimless Version also Available
- CITIZEN LED: 13W, 18W, CRI>90
- CCT: 2700K, 3000K, 4000K Available as Standard
- Beam Angle: 20°, 40°, 50°
- Lumen Output: Up to 1900lm System Luminous Flux
- IP Class: IP20 (Light Engine IP54)
- LED Driver: On-Off, Phase Dim, 1-10V Dim, DALI Dim, Casambi Wireless Dim

Light Distribution

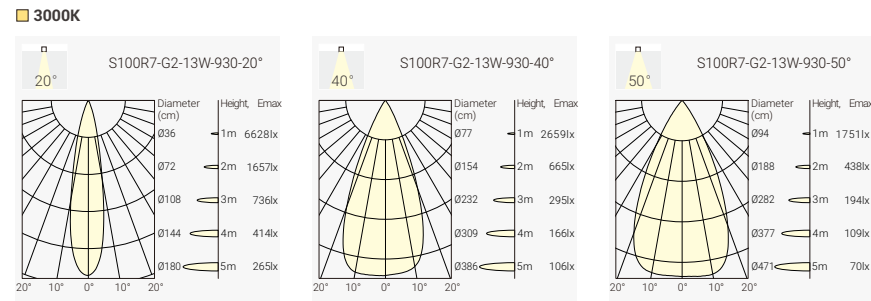

Order Info (SENSE 100-G2 Trim Version in White Trim & Dark Light Reflector as an Example)

LED Power	System Power	LED Voltage	LED Current	CRI	CCT	Beam	LED Output	System Output	Code						
13W	15W	36V	350mA	90	2700K	20°	1500lm	1100lm	SSR7G2-9272013N-WC						
						40°	1500lm	1200lm	SSR7G2-9274013N-WC						
						50°	1500lm	850lm	SSR7G2-9275013N-WC						
						3000K	20°	1600lm	1150lm	SSR7G2-9302013N-WC					
							40°	1600lm	1300lm	SSR7G2-9304013N-WC					
							50°	1600lm	900lm	SSR7G2-9305013N-WC					
						4000K	20°	1700lm	1200lm	SSR7G2-9402013N-WC					
							30°	1700lm	1350lm	SSR7G2-9404013N-WC					
							50°	1700lm	1000lm	SSR7G2-9405013N-WC					
						18W	21W	36V	500mA	90	2700K	20°	1900lm	1500lm	SSR7G2-9272018N-WC
												40°	1900lm	1700lm	SSR7G2-9274018N-WC
												50°	1900lm	1250lm	SSR7G2-9275018N-WC
3000K	20°	2000lm	1600lm	SSR7G2-9302018N-WC											
	40°	2000lm	1800lm	SSR7G2-9304018N-WC											
	50°	2000lm	1350lm	SSR7G2-9305018N-WC											
4000K	20°	2200lm	1700lm	SSR7G2-9402018N-WC											
	40°	2200lm	1900lm	SSR7G2-9404018N-WC											
	50°	2200lm	1450lm	SSR7G2-9405018N-WC											

Code Remark: N=N(No Driver) F=F(ON-OFF) P=P(Phase Dim) A=A(1-10V Dim) D=D(DALI Dim)

Coding

Model	CRI/ CCT	Beam Angle	LED Power	Control	Trim Finish	Reflector Color	Accessory
SSR7G2	927	20	13	N	W	B	H
SENSE 100-G2 Trim Verion	CR190/ 2700K	20°	13W	No Driver	White	Black	Honeycomb
SSR84G2	930	40	18	F	B	M	
SENSE 100-G2 Trimless Verion	CR190/ 3000K	40°	18W	On-Off	Black	Matt	
ESR7G2	940	50		P	W	C	
SENSE 100-G2 EI-Trimless Verion	CR190/ 4000K	50°		Phase Dim	White	Dark Light	
				A		G	
				1-10V Dim		Gold	
				D		S	
				DALI Dim		Specular	

Trim Finish



White Black

Reflector Options



Specular Matt Black Dark Light White Gold

Optional accessory



Honeycomb

Code for SSR7G2-9304013N-WM with Honeycomb
SSR7G2-9304013N-WM-H

SENSE S100HR7-G2 – Modular design architectural downlight

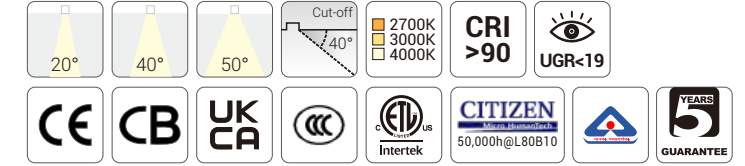

Quick Info

- Ceiling Cut-out: Ø100mm for Trim Version
- Trimless Version also Available
- CITIZEN LED: 25W, CRI>90
- CCT: 2700K, 3000K, 4000K Available as Standard
- Beam Angle: 20°, 30°, 40°, 50°
- Lumen Output: Up to 2200lm System Luminous Flux
- IP Class: IP20 (Light Engine IP54)
- LED Driver: On-Off, Phase Dim, 1-10V Dim, DALI Dim, Casambi Wireless Dim

Light Distribution

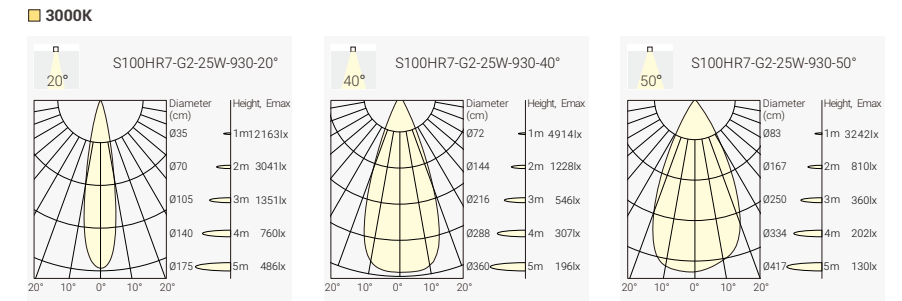

Order Info (SENSE 100H-G2 Trim Version in White Trim & Dark Light Reflector as an Example)

LED Power	System Power	LED Voltage	LED Current	CRI	CCT	Beam	LED Output	System Output	Code	
25W	28W	36V	700mA	90	2700K	20°	2400lm	1800lm	SHR7G2-9272025N-WC	
						40°	2400lm	2000lm	SHR7G2-9274025N-WC	
						50°	2400lm	1800lm	SHR7G2-9275025N-WC	
						3000K	20°	2600lm	1900lm	SHR7G2-9302025N-WC
							40°	2600lm	2100lm	SHR7G2-9304025N-WC
							50°	2600lm	1900lm	SHR7G2-9305025N-WC
						4000K	20°	2800lm	2000lm	SHR7G2-9402025N-WC
							30°	2800lm	2200lm	SHR7G2-9404025N-WC
							50°	2800lm	2000lm	SHR7G2-9404025N-WC

Code Remark: N=N(No Driver) F=F(ON-OFF) P=P(Phase Dim) A=A(1-10V Dim) D=D(DALI Dim)

Trim Finish



White Black

Reflector Options



Specular Matt Black Dark Light White Gold

Optional accessory



Honeycomb

Code for SHR1G2-9304025N-WM with Honeycomb
SHR1G2-9304025N-WM-H

Coding

Model	CRI/ CCT	Beam Angle	LED Power	Control	Trim Finish	Reflector Color	Accessory
SHR7G2	927	20	25	N	W	B	H
SENSE 100H-G2 Trim Verion	CR190/ 2700K	20°	25W	No Driver	White	Black	Honeycomb
SHR8G2	930	40		F	B	M	
SENSE 100H-G2 Trimless Verion	CR190/ 3000K	40°		On-Off	Black	Matt	
EHR7G2	940	50		P	W	C	
SENSE 100H-G2 EI-Trimless Verion	CR190/ 4000K	50°		Phase Dim	White	Dark Light	
				A		G	
				1-10V Dim		Gold	
				D		S	
				DALI Dim		Specular	

SENSE S100R2-G2 – Modular design architectural downlight

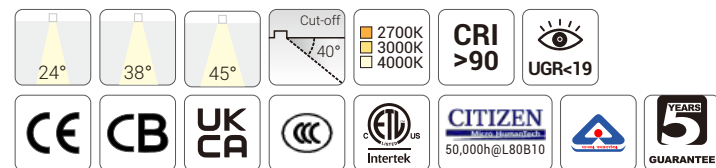
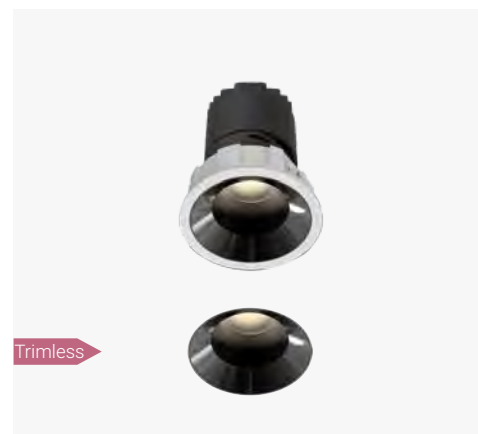

Quick Info

- Ceiling Cut-out: Ø100mm for Trim Version
- Trimless Version also Available
- CITIZEN LED: 13W, 18W, CRI>90
- CCT: 2700K, 3000K, 4000K Available as Standard
- Beam Angle: 24°, 38°, 45°
- Lumen Output: Up to 1700lm System Luminous Flux
- IP Class: IP20 (Light Engine IP54)
- LED Driver: On-Off, Phase Dim, 1-10V Dim, DALI Dim, Casambi Wireless Dim

Light Distribution

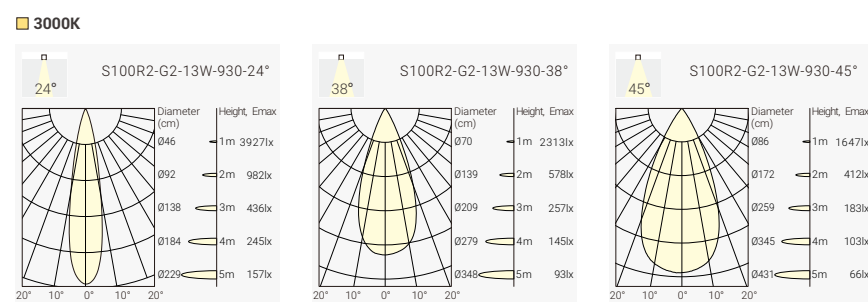

Order Info (SENSE 100-G2 Trim Version in White Trim & Dark Light Reflector as an Example)

LED Power	System Power	LED Voltage	LED Current	CRI	CCT	Beam	LED Output	System Output	Code						
13W	15W	36V	350mA	90	2700K	24°	1500lm	950lm	SSR2G2-9272413N-WC						
						38°	1500lm	1000lm	SSR2G2-9273813N-WC						
						45°	1500lm	950lm	SSR2G2-9274513N-WC						
						3000K	24°	1600lm	1000lm	SSR2G2-9302413N-WC					
							38°	1600lm	1100lm	SSR2G2-9303813N-WC					
							45°	1600lm	1000lm	SSR2G2-9304513N-WC					
						4000K	24°	1700lm	1100lm	SSR2G2-9402413N-WC					
							38°	1700lm	1200lm	SSR2G2-9403813N-WC					
							45°	1700lm	1100lm	SSR2G2-9404513N-WC					
						18W	21W	36V	500mA	90	2700K	24°	1900lm	1350lm	SSR2G2-9272418N-WC
												38°	1900lm	1450lm	SSR2G2-9273818N-WC
												50°	1900lm	1350lm	SSR2G2-9274518N-WC
3000K	24°	2000lm	1450lm	SSR2G2-9302418N-WC											
	38°	2000lm	1550lm	SSR2G2-9303818N-WC											
	45°	2000lm	1450lm	SSR2G2-9304518N-WC											
4000K	24°	2200lm	1550lm	SSR2G2-9402418N-WC											
	38°	2200lm	1700lm	SSR2G2-9403818N-WC											
	45°	2200lm	1550lm	SSR2G2-9404518N-WC											

Code Remark: N=N (No Driver) F=F (ON-OFF) P=P (Phase Dim) A=A (1-10V Dim) D=D (DALI Dim)

Coding

Model	CRI/ CCT	Beam Angle	LED Power	Control	Trim Finish	Reflector Color	Accessory
SSR2G2	927	24	13	N	W	B	H
SENSE 100-G2 Trim Verion	CR190/ 2700K	24°	13W	No Driver	White	Black	Honeycomb
SSR54G2	930	38	18	F	B	M	
SENSE 100-G2 Trimless Verion	CR190/ 3000K	38°	18W	On-Off	Black	Matt	
ESR2G2	940	45		P	W	W	
SENSE 100-G2 EI-Trimless Verion	CR190/ 4000K	45°		Phase Dim	White	White	
				A		C	
				1-10V Dim		Dark Light	
				D		G	
				DALI Dim		Gold	
						S	
						Specular	

Trim Finish



White Black

Reflector Options



Specular Matt Black Dark Light White Gold

Optional accessory



Code for SSR2G2-9303618N-WM with Honeycomb
SSR2G2-9303618N-WM-H

Honeycomb

SENSE S100HR2-G2 – Modular design architectural downlight

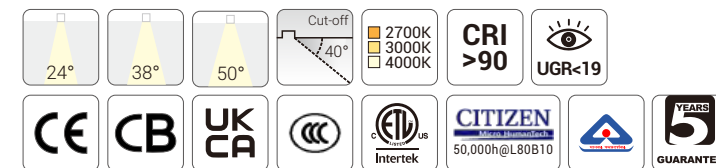
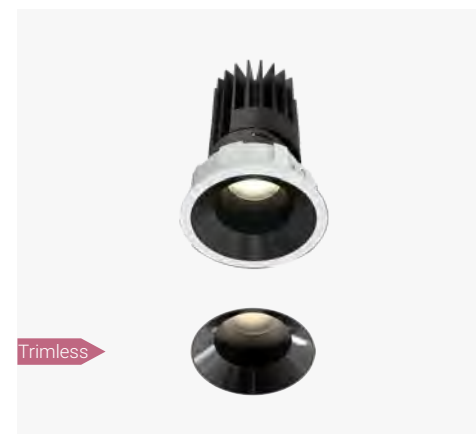

Quick Info

- Ceiling Cut-out: Ø100mm for Trim Version
- Trimless Version also Available
- CITIZEN LED: 25W, CRI>90
- CCT: 2700K, 3000K, 4000K Available as Standard
- Beam Angle: 24°, 38°, 50°
- Lumen Output: Up to 2000lm System Luminous Flux
- IP Class: IP20 (Light Engine IP54)
- LED Driver: On-Off, Phase Dim, 1-10V Dim, DALI Dim, Casambi Wireless Dim

Light Distribution

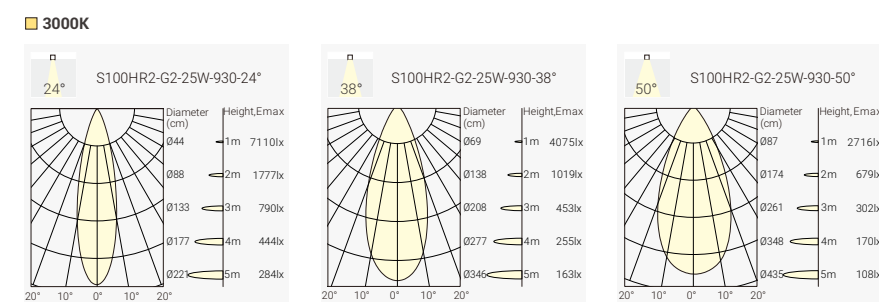

Order Info (SENSE 100H-G2 Trim Version in White Trim & Dark Light Reflector as an Example)

LED Power	System Power	LED Voltage	LED Current	CRI	CCT	Beam	LED Output	System Output	Code	
25W	28W	36V	700mA	90	2700K	24°	2400lm	1700lm	SHR2G2-9272425N-WC	
						38°	2400lm	1800lm	SHR2G2-9273825N-WC	
						50°	2400lm	1700lm	SHR2G2-9275025N-WC	
						3000K	24°	2600lm	1800lm	SHR2G2-9302425N-WC
							38°	2600lm	1900lm	SHR2G2-9303825N-WC
							50°	2600lm	1800lm	SHR2G2-9305025N-WC
						4000K	24°	2800lm	1900lm	SHR2G2-9402425N-WC
							38°	2800lm	2000lm	SHR2G2-9403825N-WC
							50°	2800lm	1900lm	SHR2G2-9405025N-WC

Code Remark: N=N (No Driver) F=F (ON-OFF) P=P (Phase Dim) A=A (1-10V Dim) D=D (DALI Dim)

Trim Finish



White Black

Reflector Options



Specular Matt Black Dark Light White Gold

Optional accessory



Code for SHR2G2-9305025N-WM with Honeycomb
SHR2G2-9305025N-WM-H

Honeycomb

Coding

Model	CRI/ CCT	Beam Angle	LED Power	Control	Trim Finish	Reflector Color	Accessory
SHR5G2	927	24	25	N	W	B	H
SENSE 100H-G2 Trim Verion	CR190/ 2700K	24°	25W	No Driver	White	Black	Honeycomb
SHR5G2	930	38		F	B	M	
SENSE 100H-G2 Trimless Verion	CR190/ 3000K	38°		On-Off	Black	Matt	
EHR5G2	940	50		P	W	W	
SENSE 100H-G2 EI-Trimless Verion	CR190/ 4000K	50°		Phase Dim	White	White	
				A		C	
				1-10V Dim		Dark Light	
				D		G	
				DALI Dim		Gold	
						S	
						Specular	

SENSE S100S2-G2 – Modular design architectural downlight

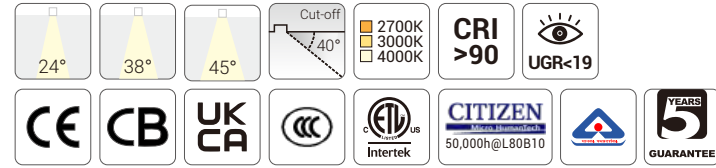

Quick Info

- Ceiling Cut-out: 96x96mm for Trim Version
- Trimless Version also Available
- CITIZEN LED: 13W, 18W, CRI>90
- CCT: 2700K, 3000K, 4000K Available as Standard
- Beam Angle: 24°, 38°, 45°
- Lumen Output: Up to 1600lm System Luminous Flux
- IP Class: IP20 (Light Engine IP54)
- LED Driver: On-Off, Phase Dim, 1-10V Dim, DALI Dim, Casambi Wireless Dim

Light Distribution

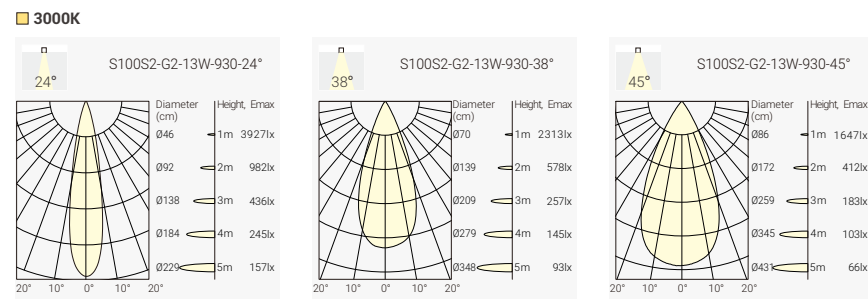

Order Info (SENSE 100-G2 Trim Version in White Trim & Dark Light Reflector as an Example)

LED Power	System Power	LED Voltage	LED Current	CRI	CCT	Beam	LED Output	System Output	Code						
13W	15W	36V	350mA	90	2700K	24°	1500lm	900lm	SSS2G2-9272413N-WC						
						38°	1500lm	950lm	SSS2G2-9273813N-WC						
						45°	1500lm	900lm	SSS2G2-9274513N-WC						
						3000K	24°	1600lm	950lm	SSS2G2-9302413N-WC					
							38°	1600lm	1000lm	SSS2G2-9303813N-WC					
							45°	1600lm	950lm	SSS2G2-9304513N-WC					
						4000K	24°	1700lm	1100lm	SSS2G2-9402413N-WC					
							38°	1700lm	1150lm	SSS2G2-9403813N-WC					
							45°	1700lm	1100lm	SSS2G2-9404513N-WC					
						18W	21W	36V	500mA	90	2700K	24°	1900lm	1200lm	SSS2G2-9272418N-WC
												38°	1900lm	1350lm	SSS2G2-9273818N-WC
												50°	1900lm	1200lm	SSS2G2-9274518N-WC
3000K	24°	2000lm	1300lm	SSS2G2-9302418N-WC											
	38°	2000lm	1450lm	SSS2G2-9303818N-WC											
	45°	2000lm	1300lm	SSS2G2-9304518N-WC											
4000K	24°	2200lm	1450lm	SSS2G2-9402418N-WC											
	38°	2200lm	1600lm	SSS2G2-9403818N-WC											
	45°	2200lm	1450lm	SSS2G2-9404518N-WC											

Code Remark N=N(No Driver) F=F(ON-OFF) P=P(Phase Dim) A=A(1-10V Dim) D=D(DALI Dim)

Coding

Model	CRI/ CCT	Beam Angle	LED Power	Control	Trim Finish	Reflector Color	Accessory
SSS2G2	927	24	13	N	W	B	H
SENSE 100-G2 Trim Verion	CR190/ 2700K	24°	13W	No Driver	White	Black	Honeycomb
SSS4G2	930	38	18	F	B	M	
SENSE 100-G2 Trimless Verion	CR190/ 3000K	38°	18W	On-Off	Black	Matt	
ESS2G2	940	45		P	W	C	
SENSE 100-G2 EI-Trimless Verion	CR190/ 4000K	45°		Phase Dim	White	Dark Light	
				A		G	
				1-10V Dim		Gold	
				D		S	
				DALI Dim		Specular	

Trim Finish



White Black

Reflector Options



Specular Matt Black Dark Light White Gold

Optional accessory



Honeycomb

Code for SSS2G2-9302413N-WM with Honeycomb
SSS2G2-9302413N-WM-H

SENSE S100HS2-G2 – Modular design architectural downlight

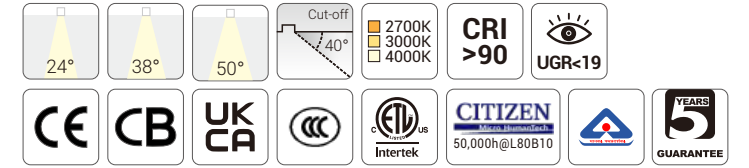

Quick Info

- Ceiling Cut-out: 96x96mm for Trim Version
- Trimless Version also Available
- CITIZEN LED: 25W, CRI>90
- CCT: 2700K, 3000K, 4000K Available as Standard
- Beam Angle: 24°, 38°, 50°
- Lumen Output: Up to 1700lm System Luminous Flux
- IP Class: IP20 (Light Engine IP54)
- LED Driver: On-Off, Phase Dim, 1-10V Dim, DALI Dim, Casambi Wireless Dim

Light Distribution

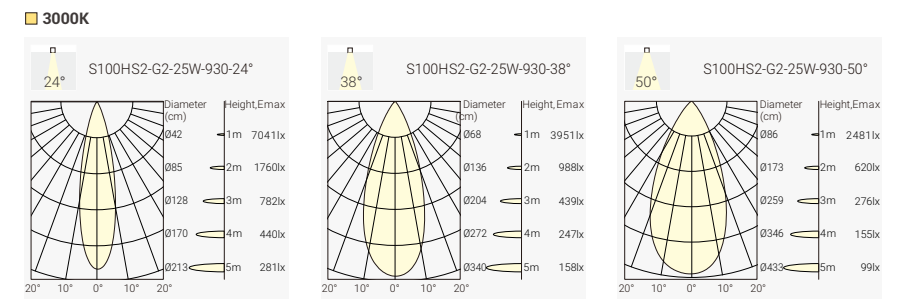

Order Info (SENSE 100H-G2 Trim Version in White Trim & Dark Light Reflector as an Example)

LED Power	System Power	LED Voltage	LED Current	CRI	CCT	Beam	LED Output	System Output	Code	
25W	28W	36V	700mA	90	2700K	24°	2400lm	1400lm	SHS2G2-9272425N-WC	
						38°	2400lm	1500lm	SHS2G2-9273825N-WC	
						50°	2400lm	1400lm	SHS2G2-9275025N-WC	
						3000K	24°	2600lm	1500lm	SHS2G2-9302425N-WC
							38°	2600lm	1600lm	SHS2G2-9303825N-WC
							50°	2600lm	1500lm	SHS2G2-9305025N-WC
						4000K	24°	2800lm	1600lm	SHS2G2-9402425N-WC
							38°	2800lm	1700lm	SHS2G2-9403825N-WC
							50°	2800lm	1600lm	SHS2G2-9405025N-WC

Code Remark N=N(No Driver) F=F(ON-OFF) P=P(Phase Dim) A=A(1-10V Dim) D=D(DALI Dim)

Trim Finish



White Black

Reflector Options



Specular Matt Black Dark Light White Gold

Optional accessory



Honeycomb

Code for SHS2G2-9302425N-WM with Honeycomb
SHS2G2-9302425N-WM-H

Coding

Model	CRI/ CCT	Beam Angle	LED Power	Control	Trim Finish	Reflector Color	Accessory
SHS2G2	927	24	25	N	W	B	H
SENSE 100-G2H Trim Verion	CR190/ 2700K	24°	25W	No Driver	White	Black	Honeycomb
SHS5G2	930	38		F	B	M	
SENSE 100H-G2 Trimless Verion	CR190/ 3000K	38°		On-Off	Black	Matt	
EHS5G2	940	50		P		W	
SENSE 100H-G2 EI-Trimless Verion	CR190/ 4000K	50°		Phase Dim		White	
				A		C	
				1-10V Dim		Dark Light	
				D		G	
				DALI Dim		Gold	
						S	
						Specular	

SENSE G2 –Modular Design Architectural Downlight System

Project: InterContinental Hefei,China





Project: Mecca cosmetic store, Australia

SENSE S125R1-G2 – Modular Design Architectural Downlight System

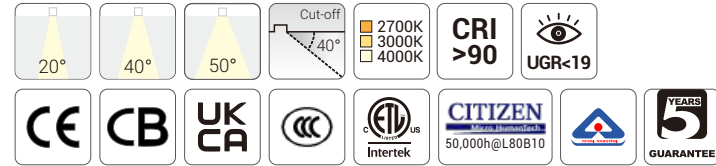

Quick Info

- Ceiling Cut-out: Ø125mm for Trim Version
- Trimless Version also Available
- CITIZEN LED: 18W, 25W, CRI>90
- CCT: 2700K, 3000K, 4000K Available as Standard
- Beam Angle: 20°, 40°, 50°
- Lumen Output: Up to 2600lm System Luminous Flux
- IP Class: IP20 (Light Engine IP54)
- LED Driver: On-Off, Phase Dim, 1-10V Dim, DALI Dim, Casambi Wireless Dim

Light Distribution

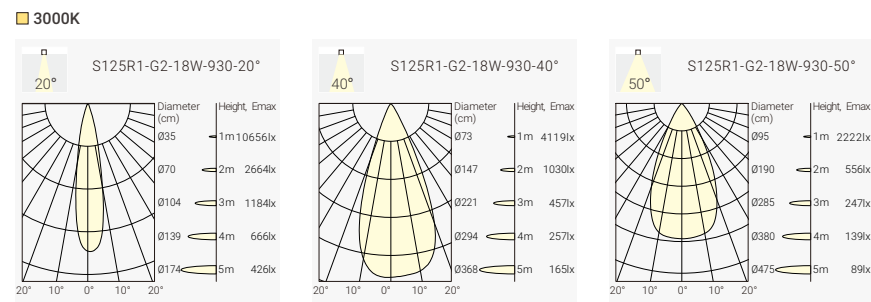

Order Info (SENSE 125-G2 Trim Version in White Trim & Dark Light Reflector as an Example)

LED Power	System Power	LED Voltage	LED Current	CRI	CCT	Beam	LED Output	System Output	Code						
18W	21W	36V	500mA	90	2700K	20°	2100lm	1600lm	SMR1G2-9272018N-WC						
						40°	2100lm	1700lm	SMR1G2-9274018N-WC						
						50°	2100lm	1500lm	SMR1G2-9275018N-WC						
						3000K	20°	2300lm	1700lm	SMR1G2-9302018N-WC					
							40°	2300lm	1800lm	SMR1G2-9304018N-WC					
							50°	2300lm	1600lm	SMR1G2-9305018N-WC					
						4000K	20°	2500lm	1800lm	SMR1G2-9402018N-WC					
							40°	2500lm	1900lm	SMR1G2-9404018N-WC					
							50°	2500lm	1700lm	SMR1G2-9405018N-WC					
						25W	28W	36V	700mA	90	2700K	20°	2900lm	2200lm	SMR1G2-9272025N-WC
												40°	2900lm	2400lm	SMR1G2-9274025N-WC
												50°	2900lm	2000lm	SMR1G2-9275025N-WC
3000K	20°	3100lm	2300lm	SMR1G2-9302025N-WC											
	40°	3100lm	2500lm	SMR1G2-9304025N-WC											
	50°	3100lm	2100lm	SMR1G2-9305025N-WC											
4000K	20°	3300lm	2400lm	SMR1G2-9402025N-WC											
	40°	3300lm	2600lm	SMR1G2-9404025N-WC											
	50°	3300lm	2200lm	SMR1G2-9405025N-WC											

Code Remark: N=N(No Driver) F=F(ON-OFF) P=P(Phase Dim) A=A(1-10V Dim) D=D(DALI Dim)

Product Code

Model	CRI/ CCT	Beam Angle	LED Power	Control	Trim Finish	Reflector Color	Accessory
SMR1G2	927	20	18	N	W	B	H
SENSE 125 Trim Verion	CRI90/ 2700K	20°	18W	No Driver	White	Black	Honeycomb
SMR4G2	930	40	25	F	B	M	
SENSE 125 Trimless Verion	CRI90/ 3000K	40°	25W	On-Off	Black	Matt	
EMR1G2	940	50		P		W	
SENSE 125 EI-Trimless Verion	CRI90/ 4000K	50°		Phase Dim		White	
				A		C	
				1-10V Dim		Dark Light	
				D		G	
				DALI Dim		Gold	
						S	
						Specular	

Trim Finish



White Black

Reflector Options



Specular Matt Black Dark Light White Gold

Optional accessory



Honeycomb

Code for SMR1G2-9405025N-WM with Honeycomb
SMR1G2-9405025N-WM-H

SENSE S125S1-G2 – Modular Design Architectural Downlight System

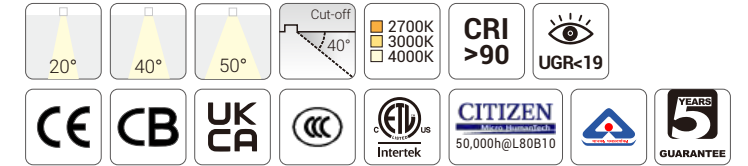

Quick Info

- Ceiling Cut-out: 122x122mm for Trim Version
- Trimless Version also Available
- CITIZEN LED: 18W, 25W, CRI>90
- CCT: 2700K, 3000K, 4000K Available as Standard
- Beam Angle: 20°, 40°, 50°
- Lumen Output: Up to 2600lm System Luminous Flux
- IP Class: IP20 (Light Engine IP54)
- LED Driver: On-Off, Phase Dim, 1-10V Dim, DALI Dim, Casambi Wireless Dim

Light Distribution

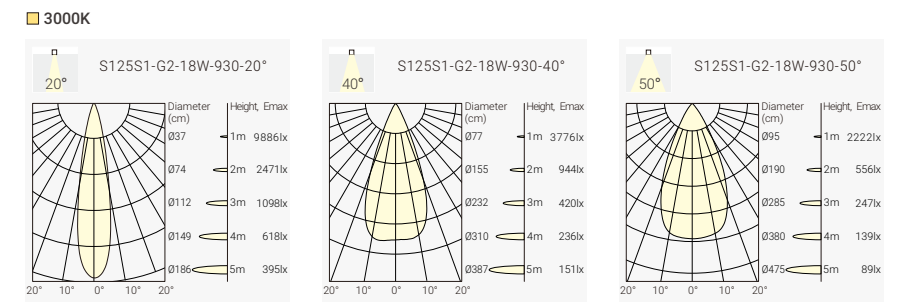

Order Info (SENSE 125-G2 Trim Version in White Trim & Dark Light Reflector as an Example)

LED Power	System Power	LED Voltage	LED Current	CRI	CCT	Beam	LED Output	System Output	Code						
18W	21W	36V	500mA	90	2700K	20°	2100lm	1500lm	SMS1G2-9272018N-WC						
						40°	2100lm	1700lm	SMS1G2-9274018N-WC						
						50°	2100lm	1500lm	SMS1G2-9275018N-WC						
						3000K	20°	2300lm	1600lm	SMS1G2-9302018N-WC					
							40°	2300lm	1800lm	SMS1G2-9304018N-WC					
							50°	2300lm	1600lm	SMS1G2-9305018N-WC					
						4000K	20°	2500lm	1700lm	SMS1G2-9402018N-WC					
							40°	2500lm	1900lm	SMS1G2-9404018N-WC					
							50°	2500lm	1700lm	SMS1G2-9405018N-WC					
						25W	28W	36V	700mA	90	2700K	20°	2900lm	2100lm	SMS1G2-9272025N-WC
												40°	2900lm	2300lm	SMS1G2-9274025N-WC
												50°	2900lm	2000lm	SMS1G2-9275025N-WC
3000K	20°	3100lm	2200lm	SMS1G2-9302025N-WC											
	40°	3100lm	2400lm	SMS1G2-9304025N-WC											
	50°	3100lm	2100lm	SMS1G2-9305025N-WC											
4000K	20°	3300lm	2300lm	SMS1G2-9402025N-WC											
	40°	3300lm	2600lm	SMS1G2-9404025N-WC											
	50°	3300lm	2200lm	SMS1G2-9405025N-WC											

Code Remark: N=N(No Driver) F=F(ON-OFF) P=P(Phase Dim) A=A(1-10V Dim) D=D(DALI Dim)

Product Code

Model	CRI/ CCT	Beam Angle	LED Power	Control	Trim Finish	Reflector Color	Accessory
SMS1G2	927	20	18	N	W	B	H
SENSE 125 Trim Verion	CRI90/ 2700K	20°	18W	No Driver	White	Black	Honeycomb
SMS4G2	930	40	25	F	B	M	
SENSE 125 Trimless Verion	CRI90/ 3000K	40°	25W	On-Off	Black	Matt	
EMS1G2	940	50		P		W	
SENSE 125 EI-Trimless Verion	CRI90/ 4000K	50°		Phase Dim		White	
				A		C	
				1-10V Dim		Dark Light	
				D		G	
				DALI Dim		Gold	
						S	
						Specular	

Trim Finish



White Black

Reflector Options



Specular Matt Black Dark Light White Gold

Optional accessory



Honeycomb

Code for SMS1G2-9405025N-WM with Honeycomb
SMS1G2-9405025N-WM-H

SENSE S125R2-G2 – Modular Design Architectural Downlight System

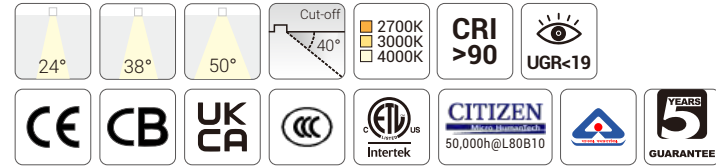
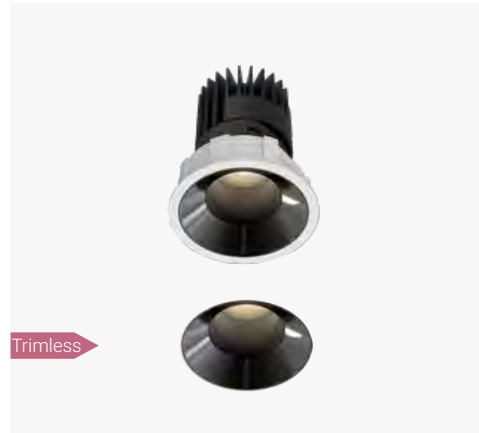

Quick Info

- Ceiling Cut-out: Ø125mm for Trim Version
- Trimless Version also Available
- CITIZEN LED: 18W, 25W, CRI>90
- CCT: 2700K, 3000K, 4000K Available as Standard
- Beam Angle: 24°, 38°, 50°
- Lumen Output: Up to 2400lm System Luminous Flux
- IP Class: IP20 (Light Engine IP54)
- LED Driver: On-Off, Phase Dim, 1-10V Dim, DALI Dim, Casambi Wireless Dim

Light Distribution

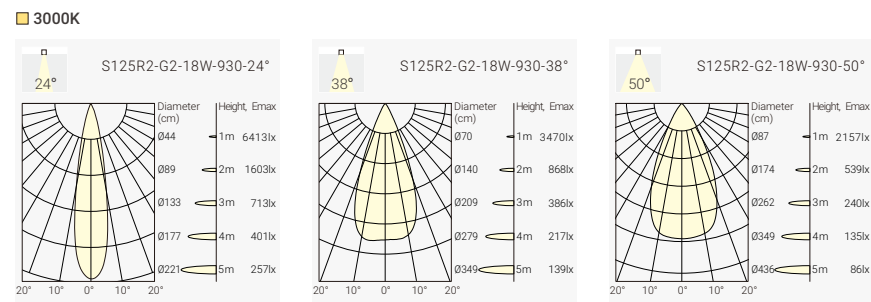

Order Info (SENSE 125-G2 Trim Version in White Trim & Dark Light Reflector as an Example)

LED Power	System Power	LED Voltage	LED Current	CRI	CCT	Beam	LED Output	System Output	Code						
18W	21W	36V	500mA	90	2700K	24°	2100lm	1500lm	SMR2G2-9272418N-WC						
						38°	2100lm	1600lm	SMR2G2-9273818N-WC						
						50°	2100lm	1400lm	SMR2G2-9275018N-WC						
						3000K	24°	2300lm	1600lm	SMR2G2-9302418N-WC					
							38°	2300lm	1700lm	SMR2G2-9303818N-WC					
							20°	2300lm	1500lm	SMR2G2-9305018N-WC					
						4000K	24°	2500lm	1700lm	SMR2G2-9404218N-WC					
							38°	2500lm	1800lm	SMR2G2-9403818N-WC					
							50°	2500lm	1600lm	SMR2G2-9405018N-WC					
						25W	28W	36V	700mA	90	2700K	24°	2900lm	2100lm	SMR2G2-9272425N-WC
												38°	2900lm	2200lm	SMR2G2-9273825N-WC
												50°	2900lm	1900lm	SMR2G2-9275025N-WC
3000K	24°	3100lm	2200lm	SMR2G2-9302425N-WC											
	38°	3100lm	2300lm	SMR2G2-9303825N-WC											
	50°	3100lm	2000lm	SMR2G2-9305025N-WC											
4000K	24°	3300lm	2300lm	SMR2G2-9402425N-WC											
	38°	3300lm	2400lm	SMR2G2-9403825N-WC											
	50°	3300lm	2100lm	SMR2G2-9405025N-WC											

Code Remark: N=N(No Driver) F=F(ON-OFF) P=P(Phase Dim) A=A(1-10V Dim) D=D(DALI Dim)

Product Code

Model	CRI/ CCT	Beam Angle	LED Power	Control	Trim Finish	Reflector Color	Accessory
SMR2G2	927	24	18	N	W	B	H
SENSE 125 Trim Verion	CRI90/ 2700K	24°	18W	No Driver	White	Black	Honeycomb
SMR5G2	930	38	25	F	B	M	
SENSE 125 Trimless Verion	CRI90/ 3000K	38°	25W	On-Off	Black	Matt	
EMR2G2	940	50		P		W	
SENSE 125 EI-Trimless Verion	CRI90/ 4000K	50°		Phase Dim		White	
				A		C	
				1-10V Dim		Dark Light	
				D		G	
				DALI Dim		Gold	
						S	
						Specular	

Trim Finish



White Black

Reflector Options



Specular Matt Black Dark Light White Gold

Optional accessory



Honeycomb

Code for SMR2G2-9405025N-WM with Honeycomb
SMR2G2-9405025N-WM-H

SENSE S125S2-G2 – Modular Design Architectural Downlight System

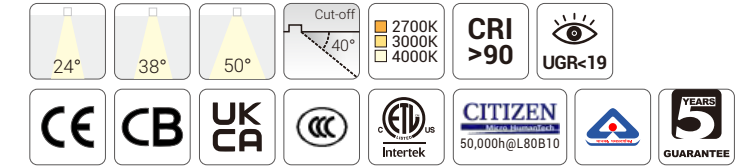

Quick Info

- Ceiling Cut-out: 122x122mm for Trim Version
- Trimless Version also Available
- CITIZEN LED: 18W, 25W, CRI>90
- CCT: 2700K, 3000K, 4000K Available as Standard
- Beam Angle: 24°, 38°, 50°
- Lumen Output: Up to 2300lm System Luminous Flux
- IP Class: IP20 (Light Engine IP54)
- LED Driver: On-Off, Phase Dim, 1-10V Dim, DALI Dim, Casambi Wireless Dim

Light Distribution

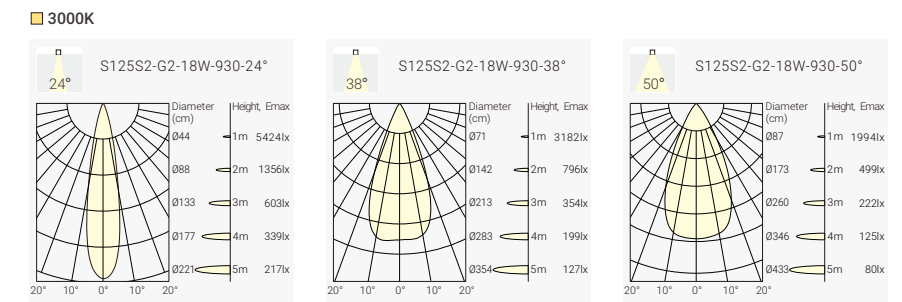

Order Info (SENSE 125-G2 Trim Version in White Trim & Dark Light Reflector as an Example)

LED Power	System Power	LED Voltage	LED Current	CRI	CCT	Beam	LED Output	System Output	Code						
18W	21W	36V	500mA	90	2700K	24°	2100lm	1300lm	SMS2G2-9272418N-WC						
						38°	2100lm	1500lm	SMS2G2-9273818N-WC						
						50°	2100lm	1200lm	SMS2G2-9275018N-WC						
						3000K	24°	2300lm	1500lm	SMS2G2-9302418N-WC					
							38°	2300lm	1600lm	SMS2G2-9303818N-WC					
							20°	2300lm	1300lm	SMS2G2-9305018N-WC					
						4000K	24°	2500lm	1500lm	SMS2G2-9404218N-WC					
							38°	2500lm	1700lm	SMS2G2-9403818N-WC					
							50°	2500lm	1400lm	SMS2G2-9405018N-WC					
						25W	28W	36V	700mA	90	2700K	24°	2900lm	1800lm	SMS2G2-9272425N-WC
												38°	2900lm	2000lm	SMS2G2-9273825N-WC
												50°	2900lm	1700lm	SMS2G2-9275025N-WC
3000K	24°	3100lm	1900lm	SMS2G2-9302425N-WC											
	38°	3100lm	2100lm	SMS2G2-9303825N-WC											
	50°	3100lm	1800lm	SMS2G2-9305025N-WC											
4000K	24°	3300lm	2100lm	SMS2G2-9402425N-WC											
	38°	3300lm	2300lm	SMS2G2-9403825N-WC											
	50°	3300lm	2000lm	SMS2G2-9405025N-WC											

Code Remark: N=N(No Driver) F=F(ON-OFF) P=P(Phase Dim) A=A(1-10V Dim) D=D(DALI Dim)

Product Code

Model	CRI/ CCT	Beam Angle	LED Power	Control	Trim Finish	Reflector Color	Accessory
SMS2G2	927	20	18	N	W	B	H
SENSE 125 Trim Verion	CRI90/ 2700K	20°	18W	No Driver	White	Black	Honeycomb
SMS5G2	930	38	25	F	B	M	
SENSE 125 Trimless Verion	CRI90/ 3000K	38°	25W	On-Off	Black	Matt	
EMS2G2	940	50		P		W	
SENSE 125 EI-Trimless Verion	CRI90/ 4000K	50°		Phase Dim		White	
				A		C	
				1-10V Dim		Dark Light	
				D		G	
				DALI Dim		Gold	
						S	
						Specular	

Trim Finish



White Black

Reflector Options



Specular Matt Black Dark Light White Gold

Optional accessory



Honeycomb

Code for SMS2G2-9405025N-WM with Honeycomb
SMS2G2-9405025N-WM-H



SENSE S150R1-G2 – Modular Design Architectural Downlight System

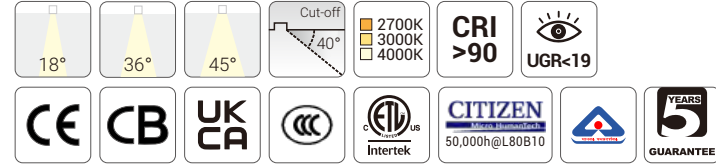

Quick Info

- Ceiling Cut-out: Ø150mm for Trim Version
- Trimless Version also Available
- CITIZEN LED: 25W, 38W, CRI>90
- CCT: 2700K, 3000K, 4000K Available as Standard
- Beam Angle: 18°, 36°, 45°
- Lumen Output: Up to 3900lm System Luminous Flux
- IP Class: IP20 (Light Engine IP54)
- LED Driver: No Driver, On-Off, Phase Dim, 1-10V Dim, DALI Dim, Casambi Wireless Dim

Light Distribution

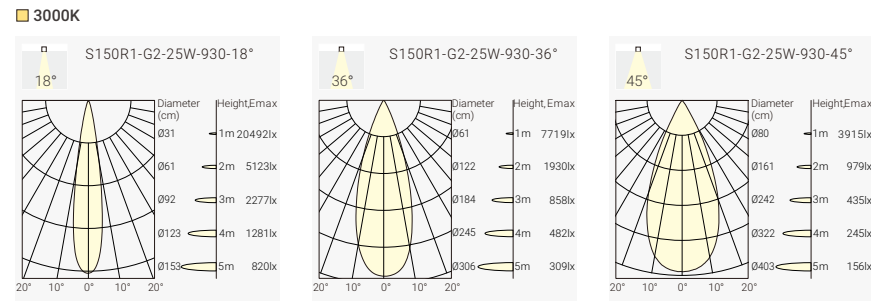

Order Info (SENSE 150-G2 Trim Version in White Trim & Dark Light Reflector as an Example)

LED Power	System Power	LED Voltage	LED Current	CRI	CCT	Beam	LED Output	System Output	Code							
25W	28W	36V	700mA	90	2700K	18°	3000lm	2300lm	SLR1G2-9271825N-WC							
						36°	3000lm	2500lm	SLR1G2-9273625N-WC							
						45°	3000lm	2000lm	SLR1G2-9274525N-WC							
						3000K	18°	3200lm	2400lm	SLR1G2-9301825N-WC						
							36°	3200lm	2600lm	SLR1G2-9303625N-WC						
							45°	3200lm	2100lm	SLR1G2-9304525N-WC						
						4000K	18°	3400lm	2500lm	SLR1G2-9401825N-WC						
							36°	3400lm	2700lm	SLR1G2-9403625N-WC						
							45°	3400lm	2200lm	SLR1G2-9404525N-WC						
							38W	42W	36V	1050mA	90	2700K	18°	4400lm	3300lm	SLR1G2-9271838N-WC
													36°	4400lm	3500lm	SLR1G2-9273638N-WC
													45°	4400lm	2800lm	SLR1G2-9274538N-WC
3000K	18°	4600lm	3500lm	SLR1G2-9301838N-WC												
	36°	4600lm	3700lm	SLR1G2-9303638N-WC												
	45°	4600lm	3000lm	SLR1G2-9304538N-WC												
	4000K	18°	4800lm	3700lm	SLR1G2-9401838N-WC											
		36°	4800lm	3900lm	SLR1G2-9403638N-WC											
		45°	4800lm	3200lm	SLR1G2-9404538N-WC											

Code Remark: N=N(No Driver) F=F(ON-OFF) P=P(Phase Dim) A=A(1-10V Dim) D=D(DALI Dim)

Product Code

Model	CRI/ CCT	Beam Angle	LED Power	Control	Trim Finish	Reflector Color	Accessory
SLR1G2	927	18	18	N	W	B	H
SENSE 150 Trim Verion	CRI90/ 2700K	18°	18W	No Driver	White	Black	Honeycomb
SLR5G2	930	36	25	F	B	M	
SENSE 150 Trimless Verion	CRI90/ 3000K	36°	25W	On-Off	Black	Matt	
ELR1G2	940	45		P		W	
SENSE 150 EI-Trimless Verion	CRI90/ 4000K	45°		Phase Dim		White	
				A		C	
				1-10V Dim		Dark Light	
				D		G	
				DALI Dim		Gold	
						S	
						Specular	

Trim Finish



White Black

Reflector Options



Specular Matt Black Dark Light White Gold

Optional accessory



Honeycomb

Code for SLR1G2-9404525N-WM with Honeycomb
SLR1G2-9404525N-WM-H

SENSE S150S1-G2 – Modular Design Architectural Downlight System

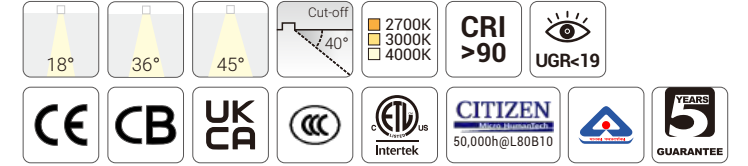

Quick Info

- Ceiling Cut-out: 147x147mm for Trim Version
- Trimless Version also Available
- CITIZEN LED: 25W, 38W, CRI>90
- CCT: 2700K, 3000K, 4000K Available as Standard
- Beam Angle: 18°, 36°, 45°
- Lumen Output: Up to 3600lm System Luminous Flux
- IP Class: IP20 (Light Engine IP54)
- LED Driver: On-Off, Phase Dim, 1-10V Dim, DALI Dim, Casambi Wireless Dim

Light Distribution

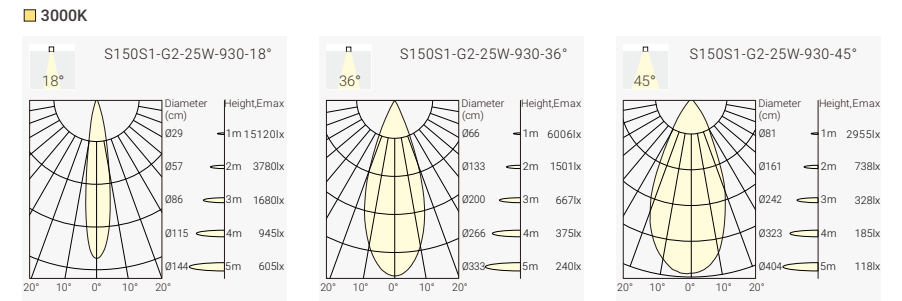

Order Info (SENSE 150-G2 Trim Version in White Trim & Dark Light Reflector as an Example)

LED Power	System Power	LED Voltage	LED Current	CRI	CCT	Beam	LED Output	System Output	Code							
25W	28W	36V	700mA	90	2700K	18°	3000lm	2000lm	SLS1G2-9271825N-WC							
						36°	3000lm	2100lm	SLS1G2-9273625N-WC							
						45°	3000lm	2000lm	SLS1G2-9274525N-WC							
						3000K	18°	3200lm	2100lm	SLS1G2-9301825N-WC						
							36°	3200lm	2200lm	SLS1G2-9303625N-WC						
							45°	3200lm	2100lm	SLS1G2-9304525N-WC						
						4000K	18°	3400lm	2200lm	SLS1G2-9401825N-WC						
							36°	3400lm	2300lm	SLS1G2-9403625N-WC						
							45°	3400lm	2200lm	SLS1G2-9404525N-WC						
							38W	42W	36V	1050mA	90	2700K	18°	4400lm	2900lm	SLS1G2-9271838N-WC
													36°	4400lm	3200lm	SLS1G2-9273638N-WC
													45°	4400lm	2900lm	SLS1G2-9274538N-WC
3000K	18°	4600lm	3100lm	SLS1G2-9301838N-WC												
	36°	4600lm	3400lm	SLS1G2-9303638N-WC												
	45°	4600lm	3100lm	SLS1G2-9304538N-WC												
	4000K	18°	4800lm	3300lm	SLS1G2-9401838N-WC											
		36°	4800lm	3600lm	SLS1G2-9403638N-WC											
		45°	4800lm	3300lm	SLS1G2-9404538N-WC											

Code Remark: N=N(No Driver) F=F(ON-OFF) P=P(Phase Dim) A=A(1-10V Dim) D=D(DALI Dim)

Product Code

Model	CRI/ CCT	Beam Angle	LED Power	Control	Trim Finish	Reflector Color	Accessory
SLS1G2	927	18	18	N	W	B	H
SENSE 150 Trim Verion	CRI90/ 2700K	18°	18W	No Driver	White	Black	Honeycomb
SLS4G2	930	36	25	F	B	M	
SENSE 150 Trimless Verion	CRI90/ 3000K	36°	25W	On-Off	Black	Matt	
ELS1G2	940	45		P		W	
SENSE 150 EI-Trimless Verion	CRI90/ 4000K	45°		Phase Dim		White	
				A		C	
				1-10V Dim		Dark Light	
				D		G	
				DALI Dim		Gold	
						S	
						Specular	

Trim Finish



White Black

Reflector Options



Specular Matt Black Dark Light White Gold

Optional accessory



Honeycomb

Code for SLS1G2-9404525N-WM with Honeycomb
SLS1G2-9404525N-WM-H

SENSE S150R2-G2 – Modular Design Architectural Downlight System

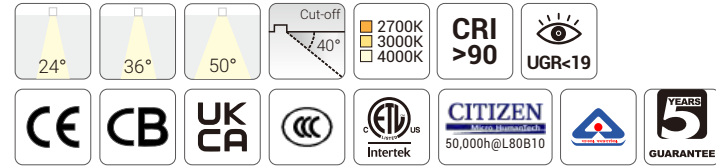
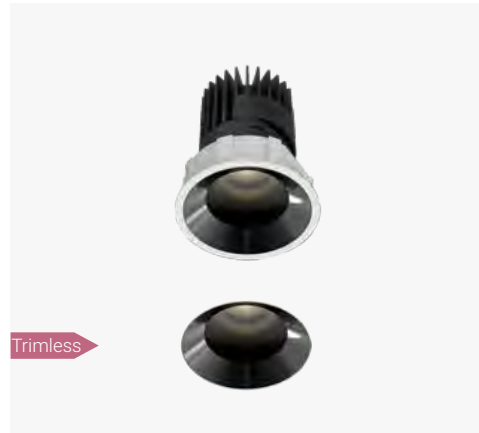

Quick Info

- Ceiling Cut-out: Ø150mm for Trim Version
- Trimless Version also Available
- CITIZEN LED: 25W, 38W, CRI>90
- CCT: 2700K, 3000K, 4000K Available as Standard
- Beam Angle: 24°, 36°, 50°
- Lumen Output: Up to 3400lm System Luminous Flux
- IP Class: IP20 (Light Engine IP54)
- LED Driver: On-Off, Phase Dim, 1-10V Dim, DALI Dim, Casambi Wireless Dim

Light Distribution

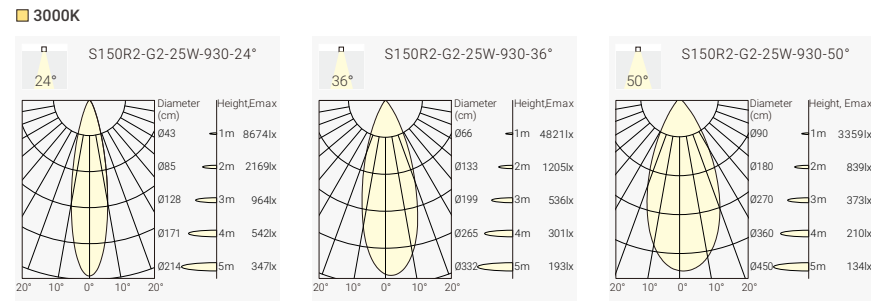

Order Info (SENSE 150-G2 Trim Version in White Trim & Dark Light Reflector as an Example)

LED Power	System Power	LED Voltage	LED Current	CRI	CCT	Beam	LED Output	System Output	Code							
25W	28W	36V	700mA	90	2700K	24°	3000lm	2100lm	SLR2G2-9272425N-WC							
						36°	3000lm	2100lm	SLR2G2-9273625N-WC							
						50°	3000lm	2100lm	SLR2G2-9275025N-WC							
						3000K	24°	3200lm	2200lm	SLR2G2-9302425N-WC						
							36°	3200lm	2200lm	SLR2G2-9303625N-WC						
							50°	3200lm	2200lm	SLR2G2-9305025N-WC						
						4000K	24°	3400lm	2300lm	SLR2G2-9402425N-WC						
							36°	3400lm	2300lm	SLR2G2-9403625N-WC						
							50°	3400lm	2300lm	SLR2G2-9405025N-WC						
							38W	42W	36V	1050mA	90	2700K	24°	4400lm	2900lm	SLR2G2-9272438N-WC
													36°	4400lm	3000lm	SLR2G2-9273638N-WC
													50°	4400lm	2900lm	SLR2G2-9275038N-WC
3000K	24°	4600lm	3100lm	SLR2G2-9302438N-WC												
	36°	4600lm	3200lm	SLR2G2-9303638N-WC												
	50°	4600lm	3100lm	SLR2G2-9305038N-WC												
4000K	24°	4800lm	3300lm	SLR2G2-9402438N-WC												
	36°	4800lm	3400lm	SLR2G2-9403638N-WC												
	50°	4800lm	3300lm	SLR2G2-9405038N-WC												

Code Remark: N=N(No Driver) F=F(ON-OFF) P=P(Phase Dim) A=A(1-10V Dim) D=D(DALI Dim)

Product Code

Model	CRI/ CCT	Beam Angle	LED Power	Control	Trim Finish	Reflector Color	Accessory
SLR2G2	927	24	25	N	W	B	H
SENSE 150 Trim Verion	CRI90/ 2700K	24°	25W	No Driver	White	Black	Honeycomb
SLR6G2	930	36	38	F	B	M	
SENSE 150 Trimless Verion	CRI90/ 3000K	36°	38W	On-Off	Black	Matt	
ELR2G2	940	50		P		W	
SENSE 150 EI-Trimless Verion	CRI90/ 4000K	50°		Phase Dim		White	
				A		C	
				1-10V Dim		Dark Light	
				D		G	
				DALI Dim		Gold	
						S	
						Specular	

Trim Finish

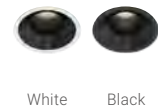

Reflector Options

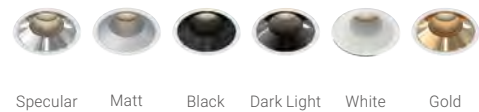

Optional accessory

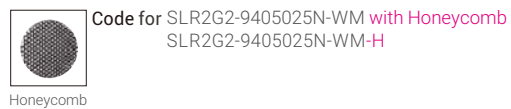

SENSE S150S2-G2 – Modular Design Architectural Downlight System

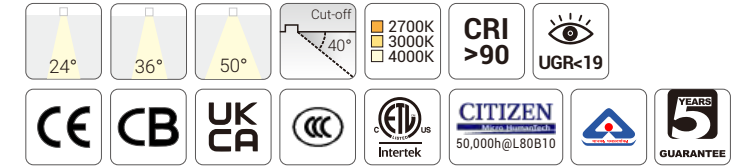

Quick Info

- Ceiling Cut-out: 147x147mm for Trim Version
- Trimless Version also Available
- CITIZEN LED: 25W, 38W, CRI>90
- CCT: 2700K, 3000K, 4000K Available as Standard
- Beam Angle: 24°, 36°, 50°
- Lumen Output: Up to 3100lm System Luminous Flux
- IP Class: IP20 (Light Engine IP54)
- LED Driver: On-Off, Phase Dim, 1-10V Dim, DALI Dim, Casambi Wireless Dim

Light Distribution

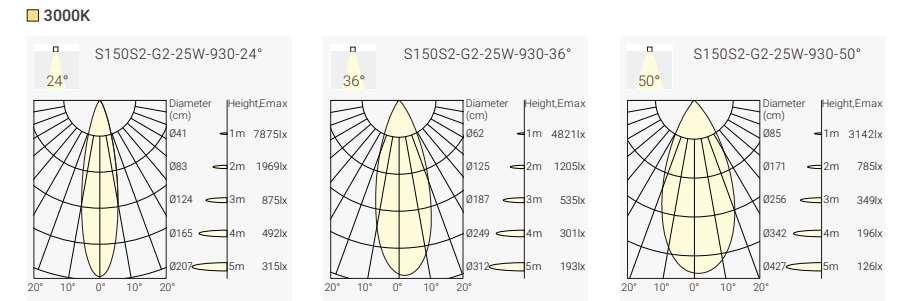

Order Info (SENSE 150-G2 Trim Version in White Trim & Dark Light Reflector as an Example)

LED Power	System Power	LED Voltage	LED Current	CRI	CCT	Beam	LED Output	System Output	Code							
25W	28W	36V	700mA	90	2700K	24°	3000lm	1800lm	SLS2G2-9272425N-WC							
						36°	3000lm	2000lm	SLS2G2-9273625N-WC							
						50°	3000lm	1900lm	SLS2G2-9275025N-WC							
						3000K	24°	3200lm	1900lm	SLS2G2-9302425N-WC						
							36°	3200lm	2100lm	SLS2G2-9303625N-WC						
							50°	3200lm	2000lm	SLS2G2-9305025N-WC						
						4000K	24°	3400lm	2000lm	SLS2G2-9402425N-WC						
							36°	3400lm	2200lm	SLS2G2-9403625N-WC						
							50°	3400lm	2100lm	SLS2G2-9405025N-WC						
							38W	42W	36V	1050mA	90	2700K	24°	4400lm	2500lm	SLS2G2-9272438N-WC
													36°	4400lm	2800lm	SLS2G2-9273638N-WC
													50°	4400lm	2700lm	SLS2G2-9275038N-WC
3000K	24°	4600lm	2600lm	SLS2G2-9302438N-WC												
	36°	4600lm	2900lm	SLS2G2-9303638N-WC												
	50°	4600lm	2850lm	SLS2G2-9305038N-WC												
4000K	24°	4800lm	2700lm	SLS2G2-9402438N-WC												
	36°	4800lm	3100lm	SLS2G2-9403638N-WC												
	50°	4800lm	3000lm	SLS2G2-9405038N-WC												

Code Remark: N=N(No Driver) F=F(ON-OFF) P=P(Phase Dim) A=A(1-10V Dim) D=D(DALI Dim)

Trim Finish



Reflector Options

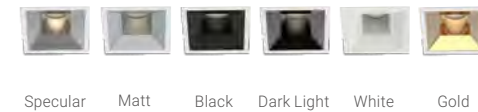

Optional accessory

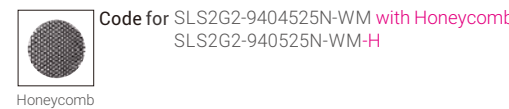

SENSE

New Wall Washer

Excellent glare control
Uniform illumination across the wall
Reflector available with specular



NEW

SENSE W75 & W100

The new technology of wall washer downlight is now part of the SENSE 2.0 Ceiling cutouts in both Ø75mm and Ø100mm sizes, offering different power and output options to meet diverse wall washing requirements across varying wall heights. Excellent glare control and uniform illumination across the wall. Reflector available in specular.

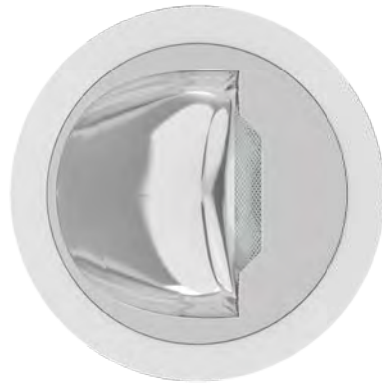

SENSE W75

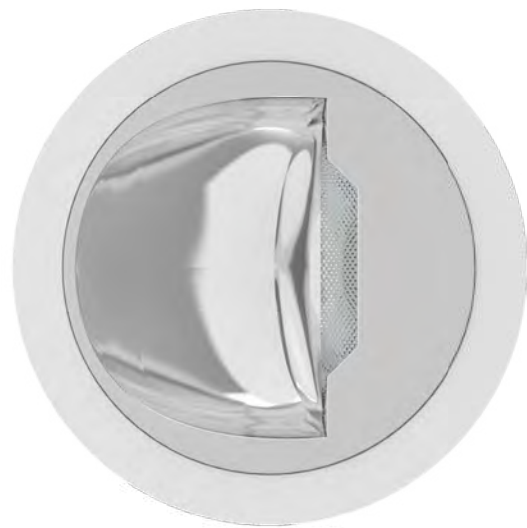

SENSE W100

Wall Washer

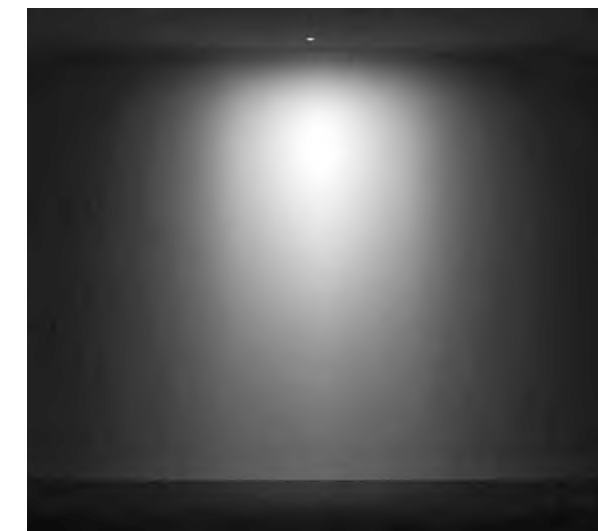
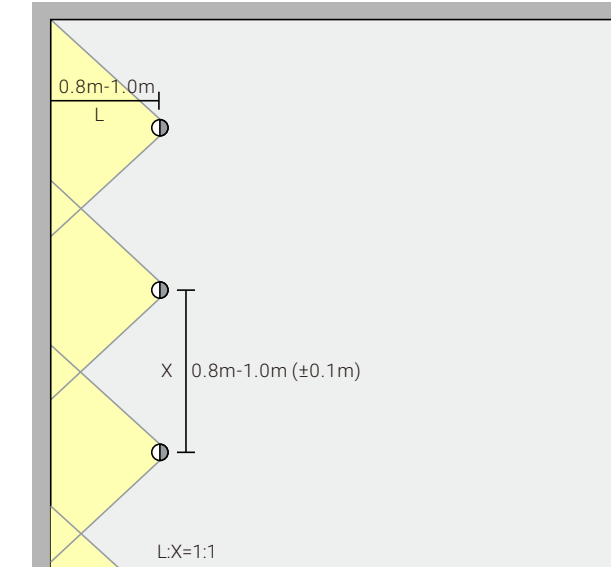
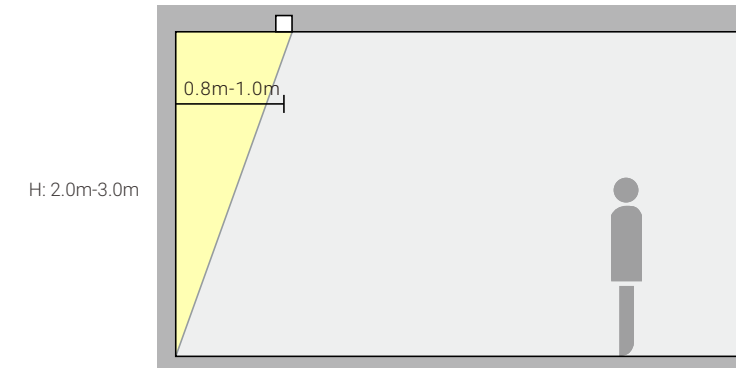

SENSE W75 – The new technology of wall washer downlight

NEW



Quick Info

- Ceiling Cut-out: Ø75mm
- CITIZEN LED: 13W, CRI>90
- CCT: 2700K, 3000K, 4000K Available as Standard
- Beam Angle: Wall Washer
- Lumen Output: Up to 900lm System Luminous Flux
- IP Class: IP20
- LED Driver: On-Off, Phase Dim, 1-10V Dim, DALI Dim, Casambi Wireless Dim

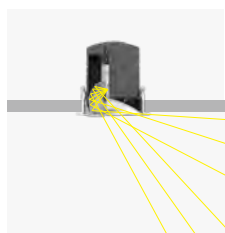
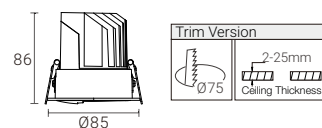

No Direct Light into Eyes

Light Distribution

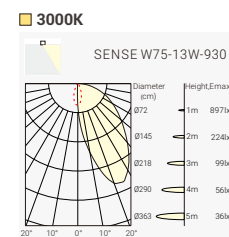

Order Info (SENSE W75 in White Trim & Specular Reflector as an Example)

LED Power	System Power	LED Voltage	LED Current	CRI	CCT	Beam	LED Output	System Output	Code
13W	15W	36V	350mA	90	2700K	Wall Washer	1200lm	800lm	S3RW-927WW13N-WS
					3000K	Wall Washer	1300lm	850lm	S3RW-930WW13N-WS
					4000K	Wall Washer	1400lm	900lm	S3RW-940WW13N-WS

Code Remark: N=N(No Driver) F=F(ON-OFF) P=P(Phase Dim) A=A(1-10V Dim) D=D(DALI Dim)

Trim Finish



White Black

Reflector Options



Specular



Coding

Model	CRI/ CCT	Beam Angle	LED Power	Control	Trim Finish	Reflector Color	Accessory
S3RW SENSE W75	927 CRI>90/ 2700K	WW Wall Washer	13 13W	N No Driver	W White	S Specular	
	930 CRI>90/ 3000K			F On-Off	B Black		
	940 CRI>90/ 4000K			P Phase Dim			
				A 1-10V Dim			
				D DALI Dim			

SENSE W100 – The new technology of wall washer downlight

NEW



Quick Info

- Ceiling Cut-out: Ø100mm
- CITIZEN LED: 17W, CRI>90
- CCT: 2700K, 3000K, 4000K Available as Standard
- Beam Angle: Wall Washer
- Lumen Output: Up to 1450lm System Luminous Flux
- IP Class: IP20
- LED Driver: On-Off, Phase Dim, 1-10V Dim, DALI Dim, Casambi Wireless Dim

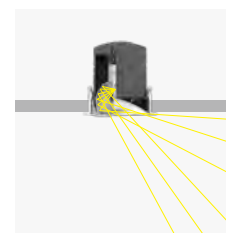
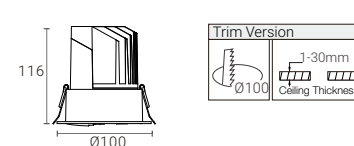

No Direct Light into Eyes

Light Distribution

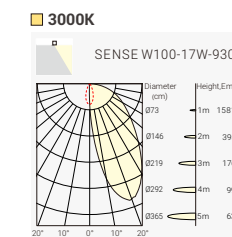

Order Info (SENSE W100 in White Trim & Specular Reflector as an Example)

LED Power	System Power	LED Voltage	LED Current	CRI	CCT	Beam	LED Output	System Output	Code
17W	20W	36V	500mA	90	2700K	Wall Washer	2300lm	1250lm	S4RW-927WW17N-WS
					3000K	Wall Washer	2400lm	1350lm	S4RW-930WW17N-WS
					4000K	Wall Washer	2600lm	1450lm	S4RW-940WW17N-WS

Code Remark: N=N(No Driver) F=F(ON-OFF) P=P(Phase Dim) A=A(1-10V Dim) D=D(DALI Dim)

Trim Finish

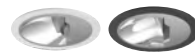

White Black

Reflector Options



Specular



Coding

Model	CRI/ CCT	Beam Angle	LED Power	Control	Trim Finish	Reflector Color	Accessory
S4RW SENSE W100	927 CRI>90/ 2700K	WW Wall Washer	17 17W	N No Driver	W White	S Specular	
	930 CRI>90/ 3000K			F On-Off	B Black		
	940 CRI>90/ 4000K			P Phase Dim			
				A 1-10V Dim			
				D DALI Dim			

TAKEO

The Interchangeable Design
Fixed Downlight Series
Round & Square
High Efficiency
UGR<19
IP54



Project: Mist Hot Spring Hotel Xuchang, China



TAKEO – High Efficiency Fixed Downlight

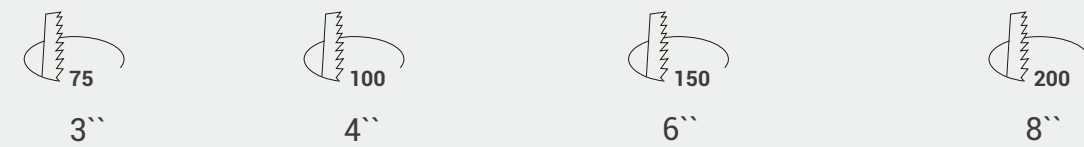
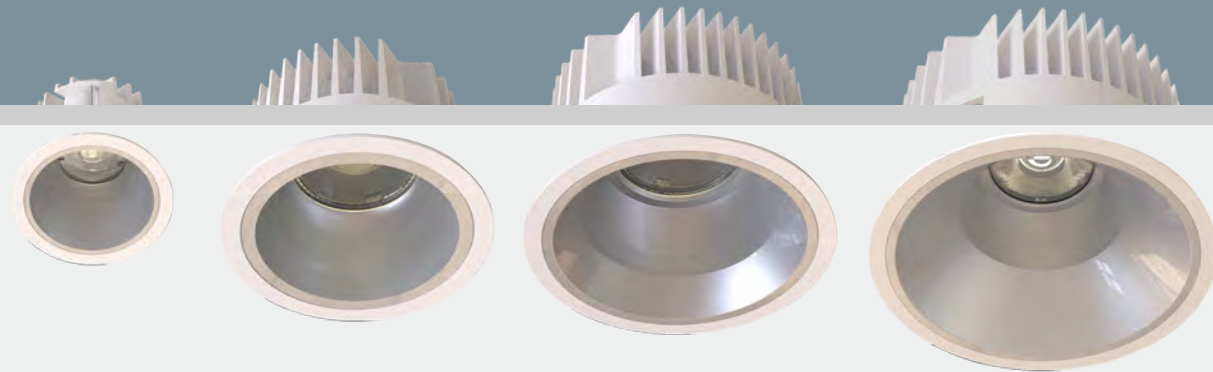

TAKEO T75 7.5W 750lm-800lm 11W 950lm-1050lm	TAKEO T100 Pro 8.5W 1200lm-1300lm 12W 1600lm-1700lm 17W 2250lm-2400lm	TAKEO T150 Pro 17W 2600lm-2800lm 24W 3500lm-3800lm	TAKEO T200 Pro 24W 3500lm-3800lm 36W 5000lm-5300lm
--	---	---	---

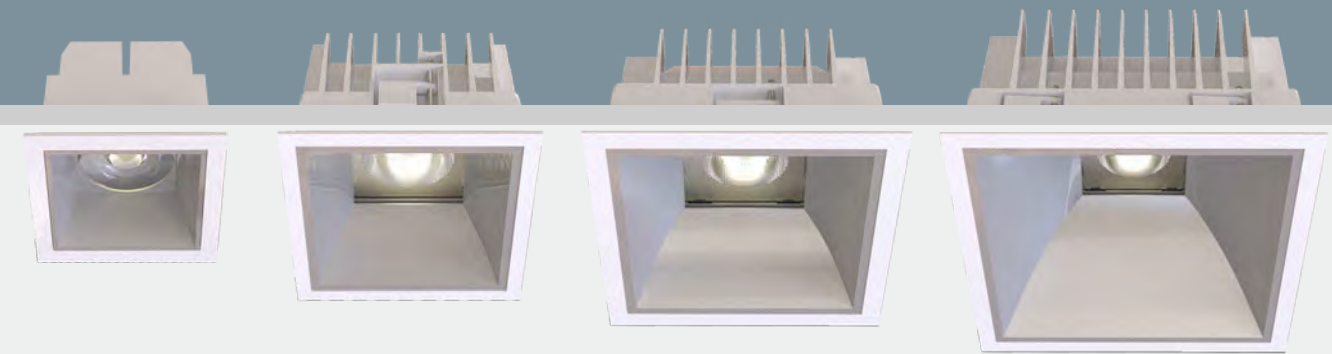

TAKEO TS68 7.5W 700lm-750lm 11W 900lm-950lm	TAKEO TS100 Pro 8.5W 1000lm-1100lm 12W 1350lm-1500lm	TAKEO TS150 Pro 17W 2050lm-2200lm 24W 2800lm-3000lm	TAKEO TS200 Pro 24W 2800lm-3000lm 36W 3900lm-4200lm
--	---	--	--



White



Black



White



Black

TAKEO – High Efficiency Fixed Downlight

Project: Office, Netherlands

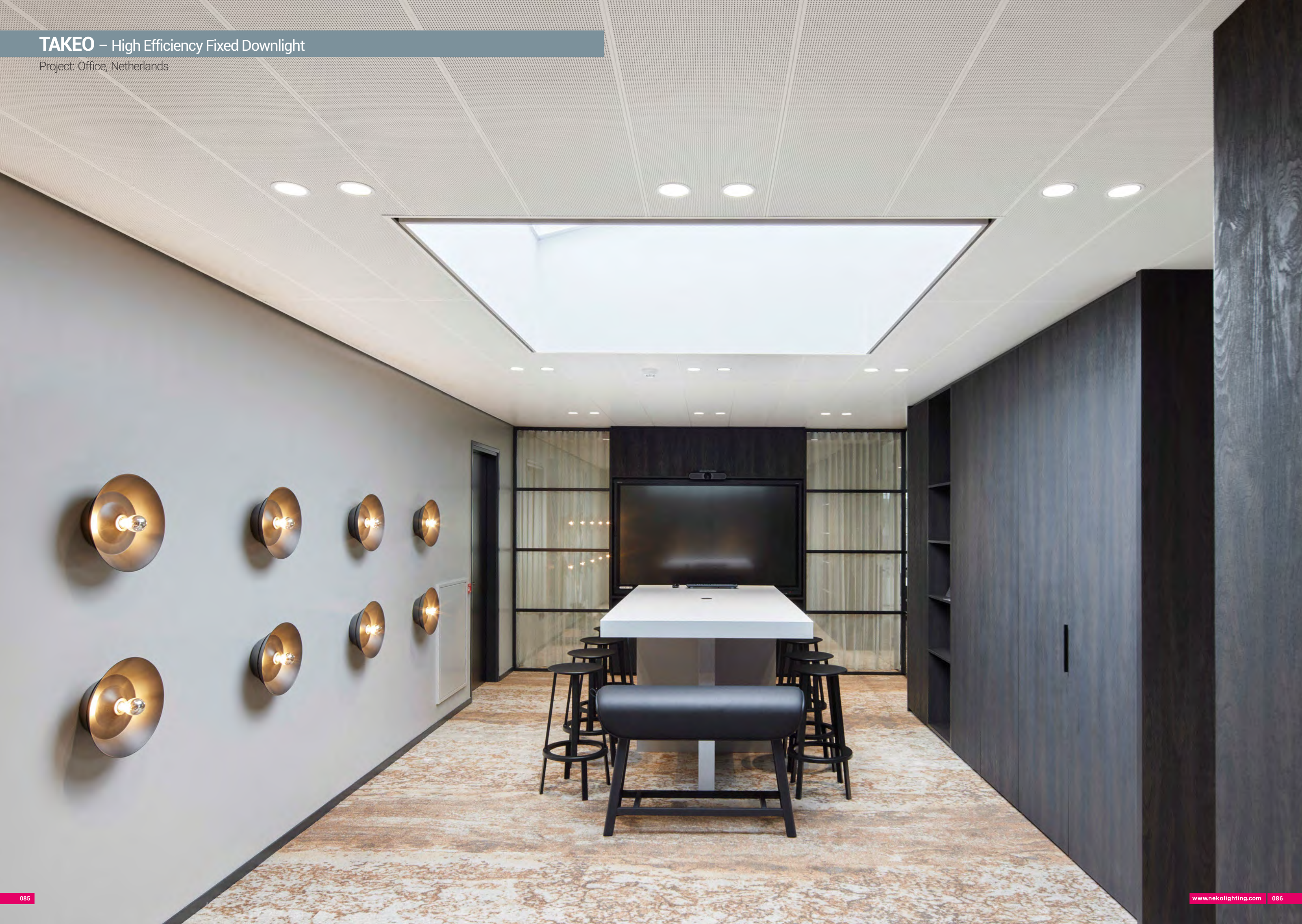



Project: Les Maçons Parisiens, Massy, France



TAKEO T75 – High Efficiency Fixed Downlight



Quick Info

- Ceiling Cut-out: Ø75mm
- CITIZEN LED: 7.5W, 11W, CRI>90, CRI>80
- CCT: 2700K, 3000K, 4000K Available as Standard
- Beam Angle: 25°, 50°
- Lumen Output: Up to 1050lm System Luminous Flux
- IP Class: IP54 from Front
- LED Driver: On-Off, Phase Dim, 1-10V Dim, DALI Dim, Casambi Wireless Dim

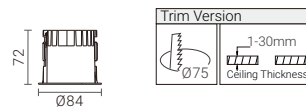

Light Distribution

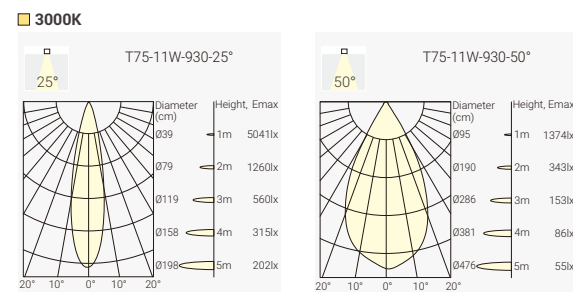

Trim Finish

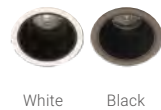

Order Info (TAKEO T75 in White Trim & Matt Reflector as an Example)

LED Power	System Power	LED Voltage	LED Current	CRI	CCT	Beam	LED Output	System Output	Code	
7.5W	9W	31V	250mA	80	2700K	25°	1000lm	720lm	TT1-8272509N-WM	
						50°	1000lm	720lm	TT1-8275009N-WM	
						3000K	25°	1100lm	750lm	TT1-8302509N-WM
						50°	1100lm	750lm	TT1-8305009N-WM	
11W	13W	31V	350mA	80	2700K	25°	1300lm	900lm	TT2-8272511N-WM	
						50°	1300lm	900lm	TT2-8275011N-WM	
						3000K	25°	1400lm	950lm	TT2-8302511N-WM
						50°	1400lm	950lm	TT2-8305011N-WM	
4000K	25°	1500lm	1050lm	TT2-8402511N-WM	50°	1500lm	1050lm	TT2-8405011N-WM		

Code Remark: N=N(No Driver) F=F(ON-OFF) P=P(Phase Dim) A=A(1-10V Dim) D=D(DALI Dim)

Reflector Options



Coding

TT1 - *** ** ** * - * * - *

Model	CRI/ CCT	Beam Angle	LED Power	Control	Trim Finish	Reflector Color	Accessory
TT1 T75-7.5W	827 CRI>80/ 2700K	25°	08 7.5W	N No Driver	W White	B Black	
TT2 T75-11W	830 CRI>80/ 3000K	50°	11 11W	F On-Off	B Black	M Matt	
				P Phase Dim	W White		
	927 CRI>90/ 2700K	A 1-10V Dim					
	930 CRI>90/ 3000K	D DALI Dim					
	940 CRI>90/ 4000K						

Project: Carita Project in Paris, France



TAKEO T100 Pro – High Efficiency Fixed Downlight



Quick Info

- Ceiling Cut-out: Ø100mm
- CITIZEN LED: 8.5W, 12W, 17W, CRI>90, CRI>80
- CCT: 2700K, 3000K, 4000K Available as Standard
- Beam Angle: 30°, 50°
- Lumen Output: Up to 2400lm System Luminous Flux
- IP Class: IP54 from Front
- LED Driver: On-Off, Phase Dim, 1-10V Dim, DALI Dim, Casambi Wireless Dim

Light Distribution

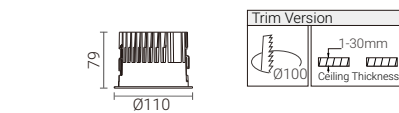
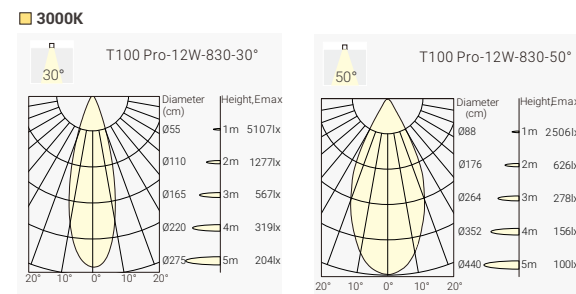

Trim Finish



White Black

Order Info (TAKEO T100 Pro in White Trim & Matt Reflector as an Example)

LED Power	System Power	LED Voltage	LED Current	CRI	CCT	Beam	LED Output	System Output	Code	
8.5W	10W	34V	250mA	80	2700K	30°	1300lm	1150lm	TS4-8272009N-WM	
						50°	1300lm	1050lm	TS4-8274009N-WM	
						3000K	30°	1400lm	1200lm	TS4-8302009N-WM
						50°	1400lm	1100lm	TS4-8305009N-WM	
12W	14W	34V	350mA	80	2700K	30°	1800lm	1500lm	TS4-8272012N-WM	
						50°	1800lm	1400lm	TS4-8274012N-WM	
						3000K	30°	1900lm	1600lm	TS4-8302012N-WM
						50°	1900lm	1500lm	TS4-8304012N-WM	
17W	20W	36V	500mA	80	2700K	30°	2500lm	2150lm	TS4-8272017N-WM	
						50°	2500lm	1900lm	TS4-8274017N-WM	
						3000K	30°	2600lm	2250lm	TS4-8302017N-WM
						50°	2600lm	2000lm	TS4-8304017N-WM	
						30°	2800lm	2400lm	TS4-8402017N-WM	
						50°	2800lm	2200lm	TS4-8404017N-WM	

Code Remark: N=N(No Driver) F=F(ON-OFF) P=P(Phase Dim) A=A(1-10V Dim) D=D(DALI Dim)

Reflector Options



White Matt Black

Coding

Model	CRI/ CCT	Beam Angle	LED Power	Control	Trim Finish	Reflector Color	Accessory
TS4	827	30	08	N	W	B	
TAKEO T100 Pro	CRI>80/ 2700K	30°	7.5W	No Driver	White	Black	
	830	50	12	F	B	M	
	CRI>80/ 3000K	50°	12W	On-Off	Black	Matt	
	840		17	P		W	
	CRI>80/ 4000K		17W	Phase Dim		White	
	927			A			
	CRI>90/ 2700K			1-10V Dim			
	930			D			
	CRI>90/ 3000K			DALI Dim			
	940						
	CRI>90/ 4000K						

Project: Office, Netherlands

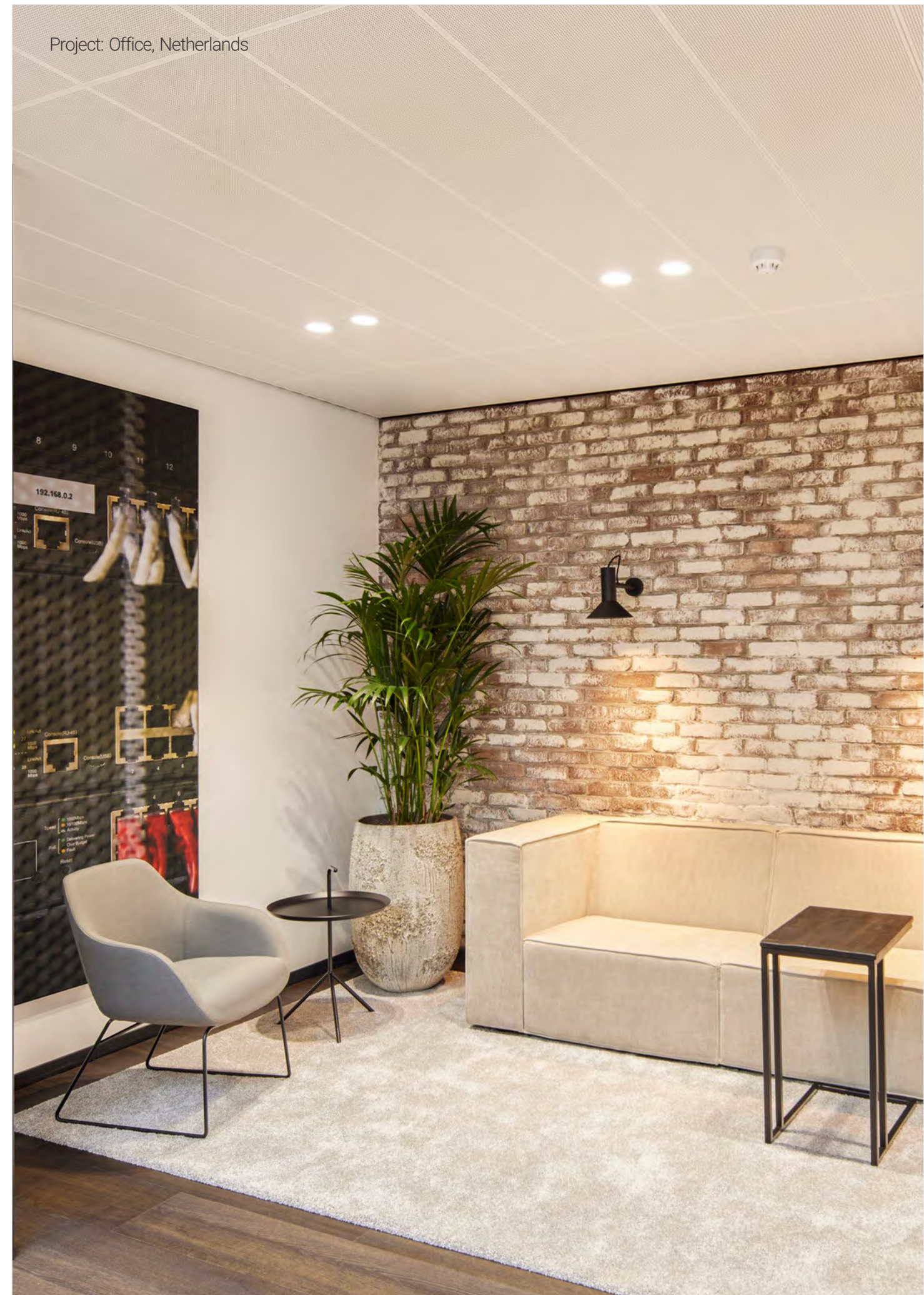

TAKEO T100-DW – High Efficiency Fixed Downlight



Quick Info

- Ceiling Cut-out: Ø100mm
- Bridgelux LED: 12W, CRI>95
- CCT: Dim to Warm 1800K-3000K
- Beam Angle: 50°
- Lumen Output: Up to Max.1000lm System Luminous Flux
- IP Class: IP54 from Front
- LED Driver: Phase Dim, 1-10V Dim, DALI Dim, Casambi Wireless Dim

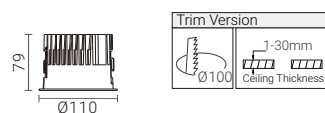

Light Distribution

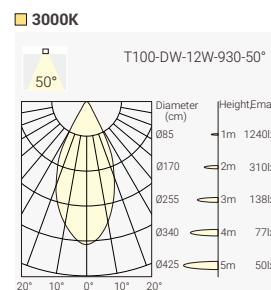

Trim Finish



Order Info (TAKEO T100-DW in White Trim & Matt Reflector as an Example)

LED Power	System Power	LED Voltage	LED Current	CRI	CCT	Beam	System Output	Code
12W	14W	34V	350mA	95	1800K-3000K	50°	Max.1000lm	TS2-9D35012N-WM

Code Remark: N=N(No Driver) P=P(Phase Dim) A=A(1-10V Dim) D=D(DALI Dim)



Reflector Options



Coding

Model	CRI/ CCT	Beam Angle	LED Power	Control	Trim Finish	Reflector Color	Accessory
TS2 TAKEO T100-DW	9D3 CRI>95 1800K-3000K	50 50°	12 12W	N No Driver P Phase Dim A 1-10V Dim D DALI Dim	W White B Black	B Black M Matt W White	

TAKEO T100-TW – High Efficiency Fixed Downlight



Quick Info

- Ceiling Cut-out: Ø100mm
- Bridgelux LED: 13W, CRI>90
- CCT: Tunable White 2700K-6500K
- Beam Angle: 50°
- Lumen Output: Up to 900lm System Luminous Flux
- IP Class: IP54 from Front
- LED Driver: DALI DT8 Dim

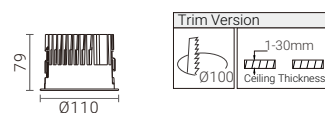

Light Distribution

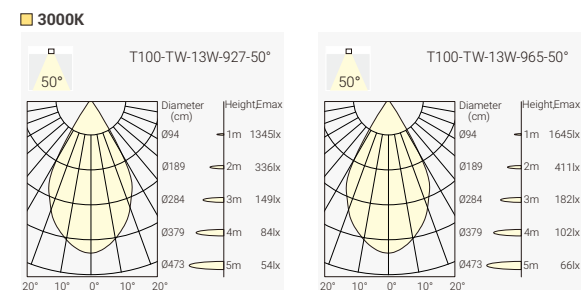

Trim Finish



Order Info (TAKEO T100-TW in White Trim & Matt Reflector as an Example)

LED Power	System Power	LED Voltage	LED Current	CRI	CCT	Beam	System Output	Code
13W	15W	36V	350mA	90	2700K-6500K	50°	Max.900lm	TS2-9TW5013N-WM

Code Remark: N=N(No Driver) D=D(DALI DT8 Dim)

Reflector Options



Coding

Model	CRI/ CCT	Beam Angle	LED Power	Control	Trim Finish	Reflector Color	Accessory
TS2 TAKEO T100-TW	9TW CRI>90 2700K-6500K	50 50°	13 13W	N No Driver D DALI DT8 Dim	W White B Black	B Black M Matt W White	

TAKEO T150 Pro – High Efficiency Fixed Downlight



Quick Info

- Ceiling Cut-out: Ø150mm
- CITIZEN LED: 17W, 24W, CRI>90, CRI>80
- CCT: 2700K, 3000K, 4000K Available as Standard
- Beam Angle: 30°, 65°
- Lumen Output: Up to 3800lm System Luminous Flux
- IP Class: IP54 from Front
- LED Driver: On-Off, Phase Dim, 1-10V Dim, DALI Dim, Casambi Wireless Dim

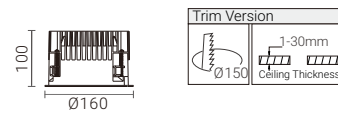

Light Distribution

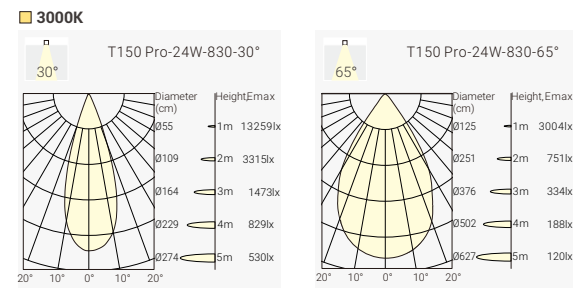

Trim Finish



Order Info (TAKEO T150 Pro in White Trim & Matt Reflector as an Example)

LED Power	System Power	LED Voltage	LED Current	CRI	CCT	Beam	LED Output	System Output	Code		
17W	19W	36V	500mA	80	2700K	30°	3000lm	2450lm	TM4-8273017N-WM		
						65°	3000lm	2000lm	TM4-8276517N-WM		
						3000K	30°	3200lm	2600lm	TM4-8303017N-WM	
							65°	3200lm	2100lm	TM4-8306517N-WM	
							4000K	30°	3500lm	2800lm	TM4-8403017N-WM
								65°	3500lm	2300lm	TM4-8406517N-WM
24W	26W	36V	700mA	80	2700K	30°	4000lm	3300lm	TM4-8273024N-WM		
						65°	4000lm	2700lm	TM4-8276524N-WM		
						3000K	30°	4200lm	3500lm	TM4-8303024N-WM	
							65°	4200lm	2850lm	TM4-8306524N-WM	
							4000K	30°	4500lm	3800lm	TM4-8403024N-WM
								65°	4500lm	3000lm	TM4-8406524N-WM

Code Remark: N=N(No Driver) F=F(ON-OFF) P=P(Phase Dim) A=A(1-10V Dim) D=D(DALI Dim)

Reflector Options



Coding

MODEL	CRI/ CCT	Beam Angle	LED Power	Control	Trim Finish	Reflector Color	Accessory
TM4 TAKEO T150 Pro	827 CRI>80/ 2700K	30	17	N No Driver	W White	B Black	
	830 CRI>80/ 3000K	65	24	F On-Off	B Black	M Matt	
	840 CRI>80/ 4000K			P Phase Dim		W White	
	927 CRI>90/ 2700K			A 1-10V Dim			
	930 CRI>90/ 3000K			D DALI Dim			
	940 CRI>90/ 4000K						

TAKEO T150-TW – High Efficiency Fixed Downlight



Quick Info

- Ceiling Cut-out: Ø150mm
- Bridgelux LED: 18W, 25W, CRI>90
- CCT: Tunable White 2700K-6500K
- Beam Angle: 60°
- Lumen Output: Up to Max.1900lm System Luminous Flux
- IP Class: IP54 from Front
- LED Driver: DALI DT8 Dim

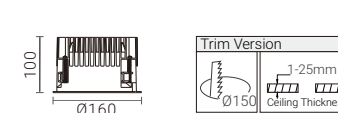

Light Distribution

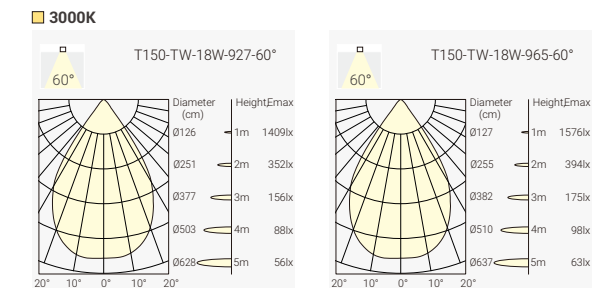

Trim Finish

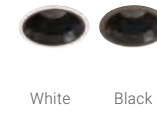

Order Info (TAKEO T150-TW in White Trim & Matt Reflector as an Example)

LED Power	System Power	LED Voltage	LED Current	CRI	CCT	Beam	System Output	Code
18W	21W	36V	500mA	90	2700K-6500K	60°	Max.1400lm	TM1-9TW6018N-WM
						@2700K	60°	1200lm
						@3000K	60°	1250lm
						@4000K	60°	1350lm
						@5000K	60°	1400lm
						@6500K	60°	1400lm
25W	28W	36V	700mA	90	2700K-6500K	60°	Max.1900lm	TM2-9TW6025N-WM
						@2700K	60°	1700lm
						@3000K	60°	1750lm
						@4000K	60°	1850lm
						@5000K	60°	1900lm
						@6500K	60°	1900lm

Code Remark: N=N(No Driver) D=D(DALI DT8 Dim)

Reflector Options



Coding

Model	CRI/ CCT	Beam Angle	LED Power	Control	Trim Finish	Reflector Color	Accessory
TM1 TAKEO T150-18W	9TW CRI>90 2700K-6500K	60	18	N No Driver	W White	B Black	
TM2 TAKEO T150-25W			25	D DALI DT8 Dim	B Black	M Matt	W White

TAKEO T200 Pro – High Efficiency Fixed Downlight

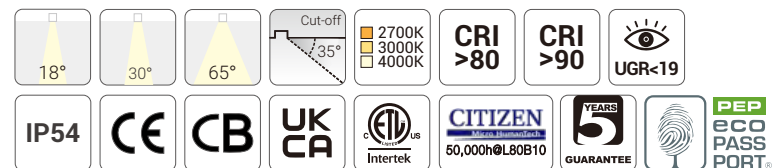

Quick Info

- Ceiling Cut-out: Ø200mm
- CITIZEN LED: 24W, 36W, CRI>90, CRI>80
- CCT: 2700K, 3000K, 4000K Available as Standard
- Beam Angle: 18°, 30°, 65°
- Lumen Output: Up to 5300lm System Luminous Flux
- IP Class: IP54 from Front
- LED Driver: On-Off, Phase Dim, 1-10V Dim, DALI Dim, Casambi Wireless Dim

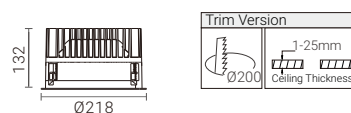

Light Distribution

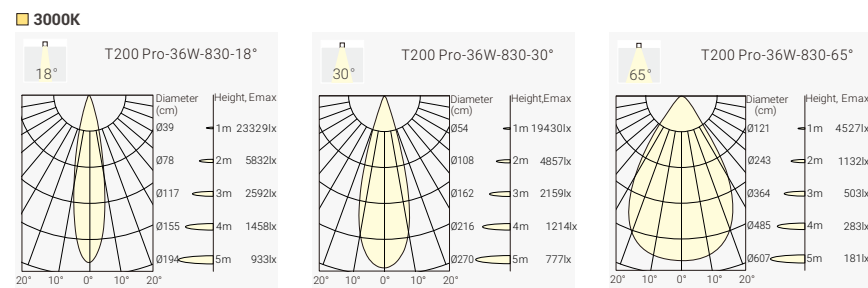

Trim Finish



Order Info (TAKEO T200 Pro in White Trim & Matt Reflector as an Example)

LED Power	System Power	LED Voltage	LED Current	CRI	CCT	Beam	LED Output	System Output	Code						
24W	26W	34V	700mA	80	2700K	18°	4200lm	3200lm	TL4-8271824N-WM						
						30°	4200lm	3300lm	TL4-8273024N-WM						
						65°	4200lm	2700lm	TL4-8276524N-WM						
						3000K	18°	4400lm	3400lm	TL4-8301824N-WM					
							30°	4400lm	3500lm	TL4-8303024N-WM					
							65°	4400lm	2900lm	TL4-8306524N-WM					
						4000K	18°	4700lm	3750lm	TL4-8401824N-WM					
							30°	4700lm	3800lm	TL4-8403024N-WM					
							65°	4700lm	3100lm	TL4-8406524N-WM					
						36W	40W	34V	1050mA	80	2700K	18°	5600lm	4600lm	TL4-8271836N-WM
												30°	5600lm	4800lm	TL4-8273036N-WM
												65°	5600lm	4000lm	TL4-8276536N-WM
3000K	18°	6000lm	4800lm	TL4-8301836N-WM											
	30°	6000lm	5000lm	TL4-8303036N-WM											
	65°	6000lm	4200lm	TL4-8306536N-WM											
4000K	18°	6500lm	5100lm	TL4-8401836N-WM											
	30°	6500lm	5300lm	TL4-8403036N-WM											
	65°	6500lm	4500lm	TL4-8406536N-WM											

Code Remark: N=N(No Driver) F=F(ON-OFF) P=P(Phase Dim) A=A(1-10V Dim) D=D(DALI Dim)

Coding

MODEL	CRI/ CCT	Beam Angle	LED Power	Control	Trim Finish	Reflector Color	Accessory
TL4	827	18	24	N	W	B	
TAKEO T200 Pro	CRI>80/ 2700K	18°	24W	No Driver	White	Black	
	830	30	36	F	B	M	
	CRI>80/ 3000K	30°	36W	On-Off	Black	Matt	
	840	65		P		W	
	CRI>80/ 4000K	65°		Phase Dim		White	
	927			A			
	CRI>90/ 2700K			1-10V Dim			
	930			D			
	CRI>90/ 3000K			DALI Dim			
	940						
	CRI>90/ 4000K						

Reflector Options



TAKEO T200-TW – High Efficiency Fixed Downlight



Quick Info

- Ceiling Cut-out: Ø200mm
- Bridgelux LED: 25W, CRI>90
- CCT: Tunable White 2700K-6500K
- Beam Angle: 60°
- Lumen Output: Up to Max.1900lm System Luminous Flux
- IP Class: IP54 from Front
- LED Driver: DALI DT8 Dim

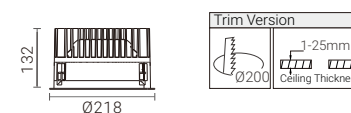

Light Distribution

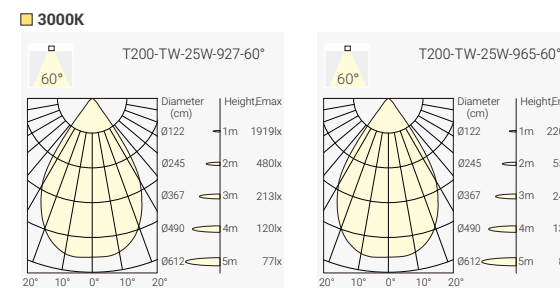

Trim Finish



Order Info (TAKEO T200-TW in White Trim & Matt Reflector as an Example)

LED Power	System Power	LED Voltage	LED Current	CRI	CCT	Beam	System Output	Code
25W	28W	36V	700mA	90	2700K-6500K	60°	Max.1900lm	TL1-9TW6025N-WM
					@2700K	60°	1700lm	
					@3000K	60°	1750lm	
					@4000K	60°	1850lm	
					@5000K	60°	1900lm	
					@6500K	60°	1900lm	

Code Remark: N=N(No Driver) D=D(DALI DT8 Dim)

Reflector Options



Coding

Model	CRI/ CCT	Beam Angle	LED Power	Control	Trim Finish	Reflector Color	Accessory
TL1	9TW	60	25	N	W	B	
TAKEO T200 TW	CRI>90 2700K-6500K	60°	25W	No Driver	White	Black	
				D	B	M	
				DALI DT8 Dim	Black	Matt	
						W	
						White	

TAKEO T150C Pro – High Efficiency Fixed Downlight

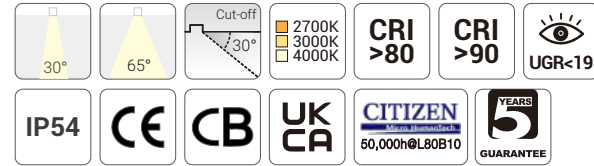
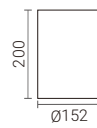

Quick Info

- CITIZEN LED: 17W, 24W, CRI>90, CRI>80
- CCT: 2700K, 3000K, 4000K Available as Standard
- Beam Angle: 30°, 65°
- Lumen Output: Up to 3800lm System Luminous Flux
- IP Class: IP54 from Front
- LED Driver: On-Off, Phase Dim, 1-10V Dim, DALI Dim

Light Distribution

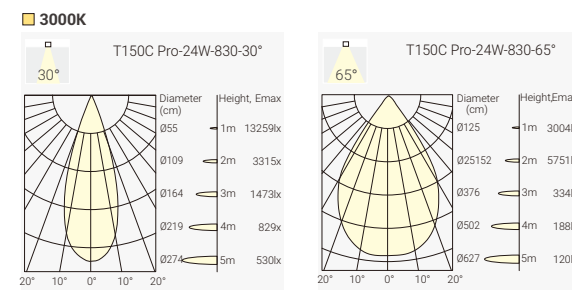

Housing Finish



White Black

Reflector Options



White Matt Black

Order Info (TAKEO T150C Pro in White Housing & Matt Reflector as an Example)

LED Power	System Power	LED Voltage	LED Current	CRI	CCT	Beam	LED Output	System Output	Code
17W	19W	36V	500mA	80	2700K	30°	3000lm	2450lm	TMC4-8273017N-WM
						65°	3000lm	2000lm	TMC4-8276517N-WM
						30°	3200lm	2600lm	TMC4-8303017N-WM
						65°	3200lm	2100lm	TMC4-8306517N-WM
24W	26W	36V	700mA	80	2700K	30°	4000lm	3300lm	TMC4-8273024N-WM
						65°	4000lm	2700lm	TMC4-8276524N-WM
						30°	4200lm	3500lm	TMC4-8303024N-WM
						65°	4200lm	2850lm	TMC4-8306524N-WM
24W	26W	36V	700mA	80	4000K	30°	4500lm	3800lm	TMC4-8403024N-WM
						65°	4500lm	3000lm	TMC4-8406524N-WM

Code Remark: N=N(No Driver) F=F(ON-OFF) P=P(Phase Dim) A=A(1-10V Dim) D=D(DALI Dim)

Coding

MODEL	CRI/ CCT	Beam Angle	LED Power	Control	Housing Finish	Reflector Color	Accessory
TMC4	827	30	17	N	W	B	
TAKEO T150C Pro	CRI>80/ 2700K	30°	17W	No Driver	White	Black	
	830	65	24	F	B	M	
	CRI>80/ 3000K	65°	24W	On-Off	Black	Matt	
	840			P		W	
	CRI>80/ 4000K			Phase Dim		White	
	927			A			
	CRI>90/ 2700K			1-10V Dim			
	930			D			
	CRI>90/ 3000K			DALI Dim			
	940						
	CRI>90/ 4000K						

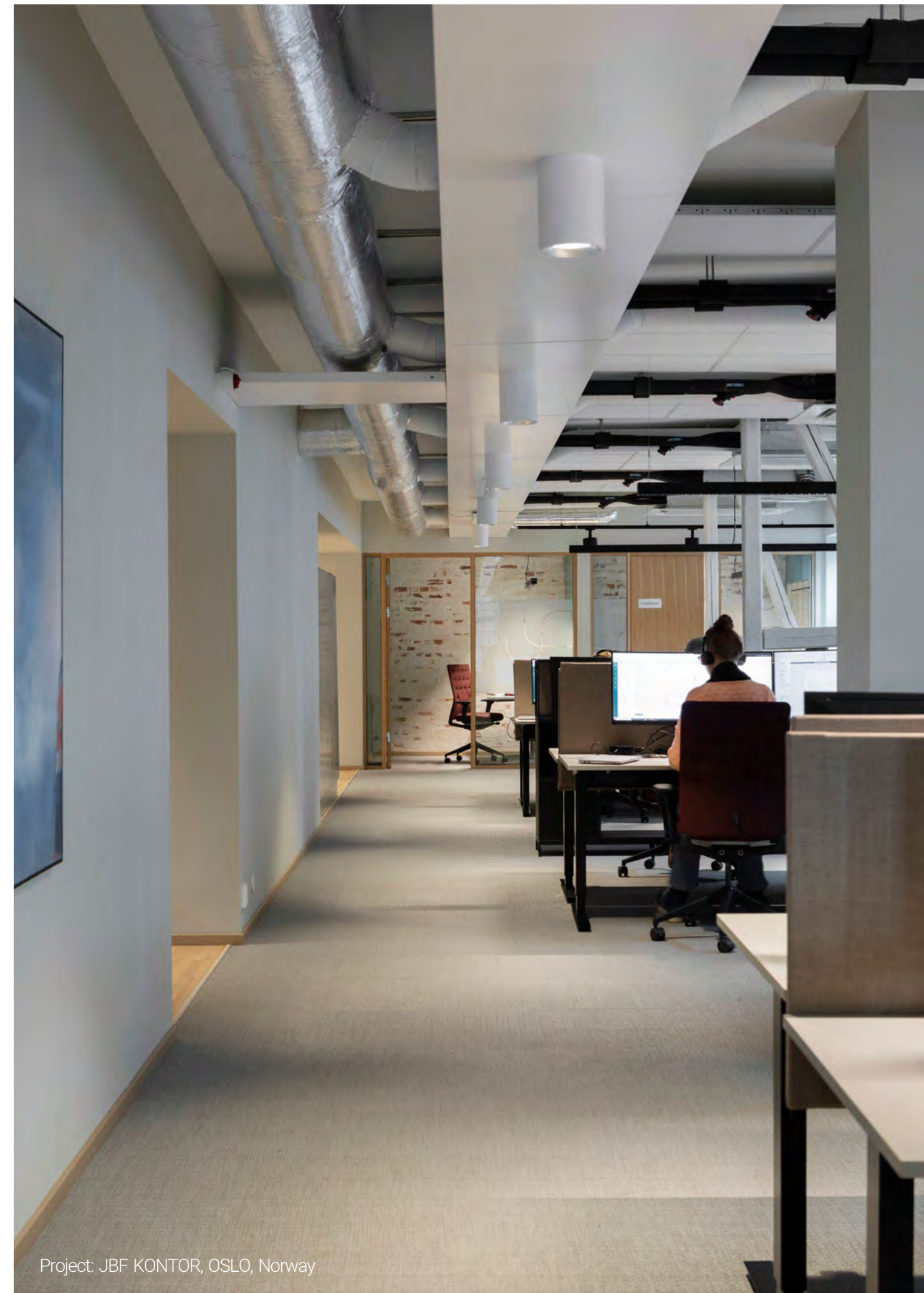

Project: JBF KONTOR, OSLO, Norway

TAKEO – High Efficiency Fixed Downlight

Project: Bank Sparkasse, German



TAKEO TS68 – High Efficiency Fixed Downlight



Quick Info

- Ceiling Cut-out: 68x68mm
- CITIZEN LED: 7.5W, 11W, CRI>90, CRI>80
- CCT: 2700K, 3000K, 4000K Available as Standard
- Beam Angle: 25°, 60°
- Lumen Output: Up to 950lm System Luminous Flux
- IP Class: IP54 from Front
- LED Driver: On-Off, Phase Dim, 1-10V Dim, DALI Dim, Casambi Wireless Dim

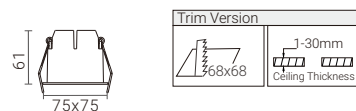

Light Distribution

3000K

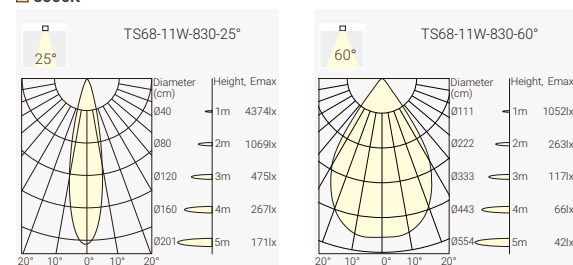

Trim Finish



White Black

Reflector Options



White Matt Black

Order Info (TAKEO TS68 in White Trim & Matt Reflector as an Example)

LED Power	System Power	LED Voltage	LED Current	CRI	CCT	Beam	LED Output	System Output	Code	
7.5W	9W	31V	250mA	80	2700K	25°	1000lm	680lm	TTS1-8272508N-WM	
						60°	1000lm	680lm	TTS1-8275008N-WM	
						3000K	25°	1100lm	700lm	TTS1-8302508N-WM
							60°	1100lm	700lm	TTS1-8305008N-WM
						4000K	25°	1200lm	750lm	TTS1-8402508N-WM
							60°	1200lm	750lm	TTS1-8405008N-WM
11W	13W	31V	350mA	80	2700K	25°	1300lm	870lm	TTS2-8272511N-WM	
						60°	1300lm	870lm	TTS2-8275011N-WM	
						3000K	25°	1400lm	900lm	TTS2-8302511N-WM
							60°	1400lm	900lm	TTS2-8305011N-WM
						4000K	25°	1500lm	950lm	TTS2-8402511N-WM
							60°	1500lm	950lm	TTS2-8405011N-WM

Code Remark: N=N(No Driver) F=F(ON-OFF) P=P(Phase Dim) A=A(1-10V Dim) D=D(DALI Dim)

Coding

Model	CRI/ CCT	Beam Angle	LED Power	Control	Trim Finish	Reflector Color	Accessory
TTS1 TAKEO TS68-7.5W	827 CRI>80/ 2700K	25 25°	08 7.5W	N No Driver	W White	B Black	
TTS2 TAKEO TS68-11W	830 CRI>80/ 3000K	60 60°	11 11W	F On-Off	B Black	M Matt	
	840 CRI>80/ 4000K			P Phase Dim		W White	
	927 CRI>90/ 2700K			A 1-10V Dim			
	930 CRI>90/ 3000K			D DALI Dim			
	940 CRI>90/ 4000K						

TAKEO TS100 Pro – High Efficiency Fixed Downlight



Quick Info

- Ceiling Cut-out: 100x100mm
- CITIZEN LED: 8.5W, 12W, CRI>90, CRI>80
- CCT: 2700K, 3000K, 4000K Available as Standard
- Beam Angle: 60°
- Lumen Output: Up to 1500lm System Luminous Flux
- IP Class: IP54 from Front
- LED Driver: On-Off, Phase Dim, 1-10V Dim, DALI Dim, Casambi Wireless Dim

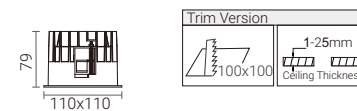

Light Distribution

3000K

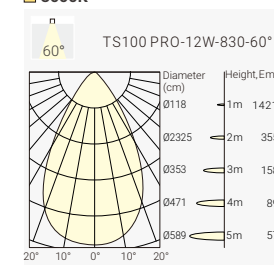

Trim Finish



White Black

Reflector Options



White Matt Black

Order Info (TAKEO TS100 Pro in White Trim & Matt Reflector as an Example)

LED Power	System Power	LED Voltage	LED Current	CRI	CCT	Beam	LED Output	System Output	Code	
8.5W	10W	34V	250mA	80	2700K	60°	1300lm	950lm	TSS4-8276009N-WM	
						3000K	60°	1400lm	1000lm	TSS4-8306009N-WM
						4000K	60°	1500lm	1100lm	TSS4-8406009N-WM
12W	14W	34V	350mA	80	2700K	60°	1800lm	1250lm	TSS4-9276012N-WM	
						3000K	60°	1900lm	1350lm	TSS4-9306012N-WM
						4000K	60°	2050lm	1500lm	TSS4-9406012N-WM

Code Remark: N=N(No Driver) F=F(ON-OFF) P=P(Phase Dim) A=A(1-10V Dim) D=D(DALI Dim)

Coding

Model	CRI/ CCT	Beam Angle	LED Power	Control	Trim Finish	Reflector Color	Accessory
TSS4 TAKEO TS100 Pro	827 CRI>80/ 2700K	60 60°	09 8.5W	N No Driver	W White	B Black	
	830 CRI>80/ 3000K		12 12W	F On-Off	B Black	M Matt	
	840 CRI>80/ 4000K			P Phase Dim		W White	
	927 CRI>90/ 2700K			A 1-10V Dim			
	930 CRI>90/ 3000K			D DALI Dim			
	940 CRI>90/ 4000K						

TAKEO TS150 Pro – High Efficiency Fixed Downlight



Quick Info

- Ceiling Cut-out: 150x150mm
- CITIZEN LED: 17W, 24W, CRI>90, CRI>80
- CCT: 2700K, 3000K, 4000K Available as Standard
- Beam Angle: 70°
- Lumen Output: Up to 3000lm System Luminous Flux
- IP Class: IP54 from Front
- LED Driver: On-Off, Phase Dim, 1-10V Dim, DALI Dim, Casambi Wireless Dim

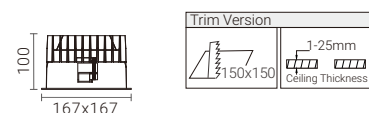

Light Distribution

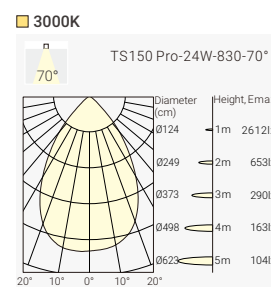

Trim Finish



White Black

Reflector Options



White Matt Black

Order Info (TAKEO TS150 Pro in White Trim & Matt Reflector as an Example)

LED Power	System Power	LED Voltage	LED Current	CRI	CCT	Beam	LED Output	System Output	Code	
17W	19W	36V	500mA	80	2700K	70°	3000lm	1900lm	TSM4-8277017N-WM	
						3000K	70°	3200lm	2050lm	TSM4-8307017N-WM
						4000K	70°	3500lm	2200lm	TSM4-8407017N-WM
24W	26W	36V	700mA	80	2700K	70°	4000lm	2700lm	TSM4-8277024N-WM	
						3000K	70°	4200lm	2800lm	TSM4-8307024N-WM
						4000K	70°	4500lm	3000lm	TSM4-8407024N-WM

Code Remark: N=N(No Driver) F=F(ON-OFF) P=P(Phase Dim) A=A(1-10V Dim) D=D(DALI Dim)

Coding

Model	CRI/ CCT	Beam Angle	LED Power	Control	Trim Finish	Reflector Color	Accessory
TSSM4	827	70	17	N	W	B	
TAKEO TS150 Pro	CRI>80/ 2700K	70°	17W	No Driver	White	Black	
	830		24	F	B	M	
	CRI>80/ 3000K		24W	On-Off	Black	Matt	
	840			P		W	
	CRI>80/ 4000K			Phase Dim		White	
	927			A			
	CRI>90/ 2700K			1-10V Dim			
	930			D			
	CRI>90/ 3000K			DALI Dim			
	940						
	CRI>90/ 4000K						

TAKEO TS200 Pro – High Efficiency Fixed Downlight



Quick Info

- Ceiling Cut-out: 200x200mm
- CITIZEN LED: 24W, 36W, CRI>90, CRI>80
- CCT: 2700K, 3000K, 4000K Available as Standard
- Beam Angle: 70°
- Lumen Output: Up to 4200lm System Luminous Flux
- IP Class: IP54 from Front
- LED Driver: On-Off, Phase Dim, 1-10V Dim, DALI Dim, Casambi Wireless Dim

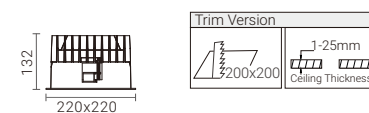

Light Distribution

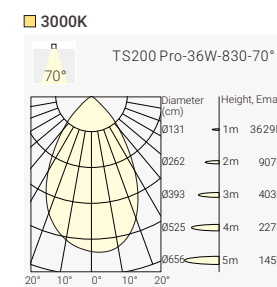

Trim Finish



White Black

Reflector Options



White Matt Black

Order Info (TAKEO TS200 Pro in White Trim & Matt Reflector as an Example)

LED Power	System Power	LED Voltage	LED Current	CRI	CCT	Beam	LED Output	System Output	Code	
24W	26W	34V	700mA	80	2700K	70°	4200lm	2700lm	TSL4-8277024N-WM	
						3000K	70°	4400lm	2800lm	TSL4-8307024N-WM
						4000K	70°	4700lm	3000lm	TSL4-8407024N-WM
36W	40W	34V	1050mA	80	2700K	70°	5600lm	3700lm	TSL4-8277036N-WM	
						3000K	70°	6000lm	3900lm	TSL4-8307036N-WM
						4000K	70°	6500lm	4200lm	TSL4-8407036N-WM

Code Remark: N=N(No Driver) F=F(ON-OFF) P=P(Phase Dim) A=A(1-10V Dim) D=D(DALI Dim)

Coding

Model	CRI/ CCT	Beam Angle	LED Power	Control	Trim Finish	Reflector Color	Accessory
TSL4	827	70	24	N	W	B	
TAKEO TS200 Pro	CRI>80/ 2700K	70°	24W	No Driver	White	Black	
	830		36	F	B	M	
	CRI>80/ 3000K		36W	On-Off	Black	Matt	
	840			P		W	
	CRI>80/ 4000K			Phase Dim		White	
	927			A			
	CRI>90/ 2700K			1-10V Dim			
	930			D			
	CRI>90/ 3000K			DALI Dim			
	940						
	CRI>90/ 4000K						

VISION

The Cut-out 68
Powerful
Fixed Downlight
Wall Washer Downlight

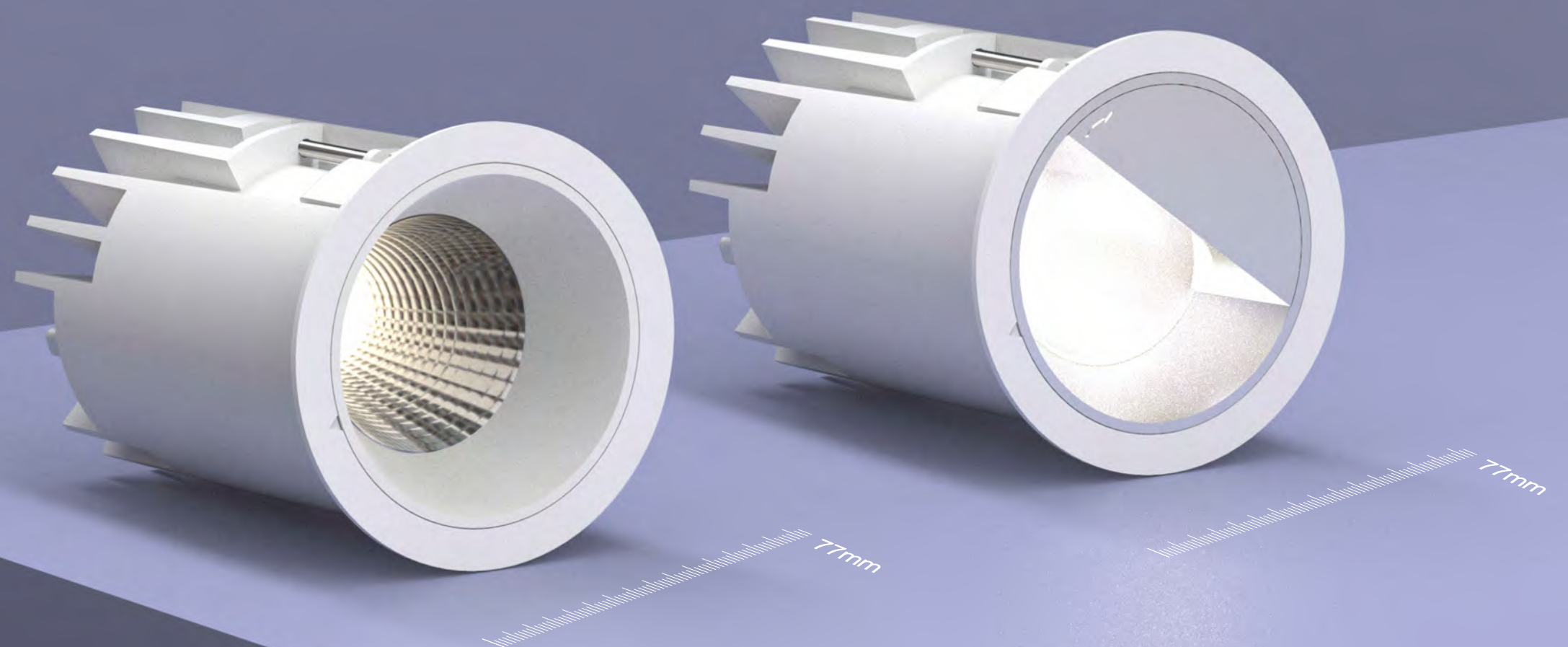

VISION V68 – The Cut-out 68 Powerful Fixed Downlight



Quick Info

- Ceiling Cut-out: Ø68mm
- CITIZEN LED: 13W, 18W, CRI>90
- CCT: 2700K, 3000K, 4000K Available as Standard
- Beam Angle: 18°, 40°
- Lumen Output: Up to 1700lm System Luminous Flux
- IP Class: IP20 from Front
- LED Driver: On-Off, Phase Dim, 1-10V Dim, DALI Dim, Casambi Wireless Dim

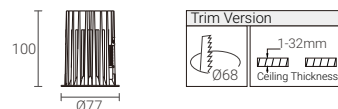

Light Distribution

3000K

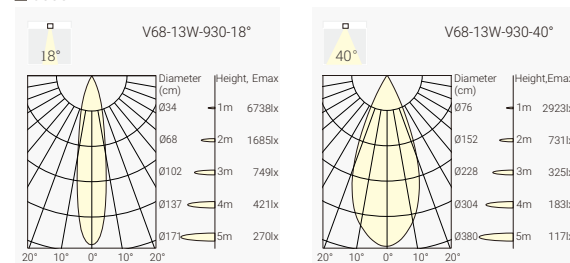

Order Info (VISION V68 in White Trim & Specual Reflector as an Example)

LED Power	System Power	LED Voltage	LED Current	CRI	CCT	Beam	LED Output	System Output	Code
13W	15W	36V	350mA	90	2700K	18°	1400lm	1100lm	VF68-9271813N-WS
						40°	1400lm	1100lm	VF68-9274013N-WS
						18°	1500lm	1200lm	VF68-9301813N-WS
						40°	1500lm	1200lm	VF68-9304013N-WS
18W	21W	36V	500mA	90	2700K	18°	1900lm	1500lm	VF68-9271818N-WS
						40°	1900lm	1500lm	VF68-9274018N-WS
						18°	2000lm	1600lm	VF68-9301818N-WS
						40°	2000lm	1600lm	VF68-9304018N-WS
18W	21W	36V	500mA	90	3000K	18°	2200lm	1700lm	VF68-9401818N-WS
						40°	2200lm	1700lm	VF68-9404018N-WS
						18°	2200lm	1700lm	VF68-9401818N-WS
						40°	2200lm	1700lm	VF68-9404018N-WS

Code Remark: N=N(No Driver) F=F(ON-OFF) P=P(Phase Dim) A=A(1-10V Dim) D=D(DALI Dim)

Trim Finish



Reflector Options

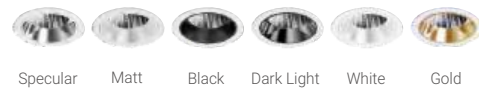

Coding

Model	CRI/ CCT	Beam Angle	LED Power	Control	Trim Finish	Reflector Color	Accessory
VF68	927	18°	13	N	W	B	
VISION V68	CRI>90/ 2700K	18°	13W	No Driver	White	Black	
	930	40°	18	F	B	M	
	CRI>90/ 3000K	40°	18W	On-Off	Black	Matt	
	940			P		W	
	CRI>90/ 4000K			Phase Dim		White	
				A		D	
				1-10V Dim		Dark Light	
				D		S	
				DALI Dim		Specular	
						G	
						Gold	

VISION V68W – The Cut-out 68 Powerful Wall Washer Downlight



Quick Info

- Ceiling Cut-out: Ø68mm
- CITIZEN LED: 13W, 18W, CRI>90
- CCT: 2700K, 3000K, 4000K Available as Standard
- Beam Angle: Wall Washer
- Lumen Output: Up to 1170lm System Luminous Flux
- IP Class: IP20 from Front
- LED Driver: On-Off, Phase Dim, 1-10V Dim, DALI Dim, Casambi Wireless Dim

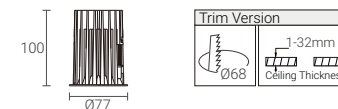

Light Distribution

3000K

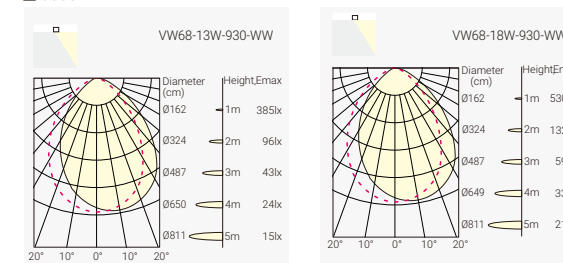

Order Info (VISION V68W in White Trim & Matt Reflector as an Example)

LED Power	System Power	LED Voltage	LED Current	CRI	CCT	Beam	LED Output	System Output	Code
13W	15W	36V	350mA	90	2700K	Wall Washer	1400lm	780lm	VW68-927WW13N-WM
						Wall Washer	1500lm	820lm	VW68-930WW13N-WM
						Wall Washer	1600lm	870lm	VW68-940WW13N-WM
18W	21W	36V	500mA	90	2700K	Wall Washer	1900lm	1050lm	VW68-927WW18N-WM
						Wall Washer	2000lm	1100lm	VW68-930WW18N-WM
						Wall Washer	2200lm	1170lm	VW68-940WW18N-WM

Code Remark: N=N(No Driver) F=F(ON-OFF) P=P(Phase Dim) A=A(1-10V Dim) D=D(DALI Dim)

Trim Finish



Reflector Options



Coding

Model	CRI/ CCT	Beam Angle	LED Power	Control	Trim Finish	Reflector Color	Accessory
VW68	927	WW	13	N	W	M	
VISION V68W	CRI>90/ 2700K	Wall Washer	13W	No Driver	White	Matt	
	930		18	F	B		
	CRI>90/ 3000K		18W	On-Off	Black		
	940			P			
	CRI>90/ 4000K			Phase Dim			
				A			
				1-10V Dim			
				D			
				DALI Dim			

PASSION

Excellent balance between eye comfort and high efficiency

Light source deep integrated for glare control (UGR<19) with a 30° shielding angle

Beam angle in 60° with opal cover

Single CCT version available in 3000K or 4000K, for high efficiency (up to 140lm/W)

Switchable CCT version in 3000K-3500K-4000K switchable, easier for keeping stock.

IP54 rating, suitable for indoor environments with moderate moisture and dust levels

Product finish in White-Specular(WS), White-Matt(WM), White-White(WW), Black-Black(BB)



PASSION 100 – The High Efficiency Fixed Downlight

NEW



Quick Info

- Ceiling Cut-out: Ø100mm
- LED: 8W, 12W, CRI>80, CRI>90
- CCT: Single 3000K, 4000K or 3000K-3500K-4000K CCT Switchable
- Beam Angle: 60° within Opal Cover
- Lumen Output: Up to 1750lm System Luminous Flux
- IP Class: IP54 from Front
- LED Driver: On-Off, Phase Dim, 1-10V Dim, DALI Dim, Casambi Wireless Dim

Light Distribution

3000K

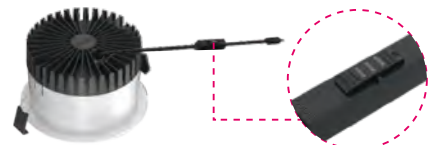
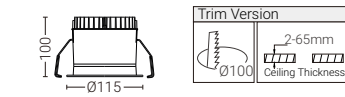
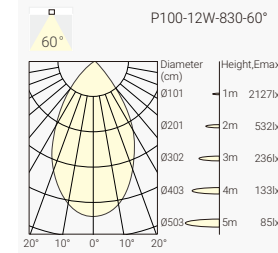

3000K-3500K-4000K CCT Switchable Version

Finish

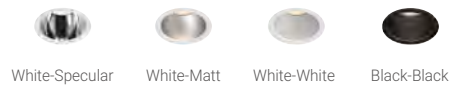

Order Info (PASSION 100 in White-Specular Finish as an Example)

LED Power	System Power	LED Voltage	LED Current	CRI	CCT	Beam LED Output	System Output	Code
8W	10W	33V	250mA	80	3000K 4000K	60° 1500lm 60° 1600lm	1100lm 1200lm	PAN4-8306008N-WS PAN4-8406008N-WS
12W	14W	33V	350mA	80	3000K 4000K	60° 2100lm 60° 2300lm	1650lm 1750lm	PAN4-8306012N-WS PAN4-8406012N-WS
8W	10W	33V	250mA	80	3000K-3500K-4000K	60° 1500lm	Max. 1150lm	PAN4-8S306008N-WS
13W	15W	33V	350mA	80	3000K-3500K-4000K	60° 2100lm	Max. 1600lm	PAN4-8S306013N-WS

Code Remark: N=N(No Driver) F=F(ON-OFF) P=P(Phase Dim) A=A(1-10V Dim) D=D(DALI Dim)

Coding

Model	CRI/ CCT	Beam Angle	LED Power	Control	Trim Finish-Reflector Color	Accessory
PAN4	830	60	08	N	WS	
PASSION 100	CRI>80/ 3000K	60°	8W	No Driver	White-Specular	
	840		12	F	WM	
	CRI>80/ 4000K		12W	On-Off	White-Matt	
	8S3			P	WW	
	CRI>80/ 3000K-3500K-4000K			Phase Dim	White-White	
	930			A	BB	
	CRI>90/ 3000K			1-10V Dim	Black-Black	
	940			D		
	CRI>90/ 4000K			DALI Dim		
	9S3					
	CRI>90/ 3000K-3500K-4000K					



Project: Application Reference

PASSION 150 – The High Efficiency Fixed Downlight

NEW

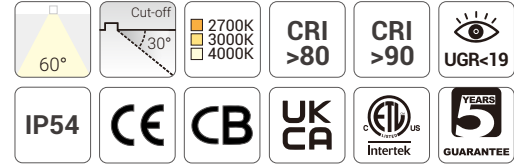

Quick Info

- Ceiling Cut-out: Ø150mm
- LED: 16W, 23W, CRI>80, CRI>90
- CCT: Single 3000K, 4000K or 3000K-3500K-4000K CCT Switchable
- Beam Angle: 60° within Opal Cover
- Lumen Output: Up to 3500lm System Luminous Flux
- IP Class: IP54 from Front
- LED Driver: On-Off, Phase Dim, 1-10V Dim, DALI Dim, Casambi Wireless Dim

Light Distribution

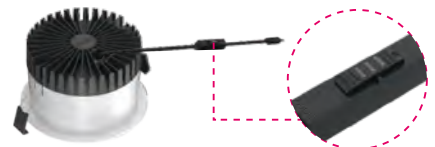
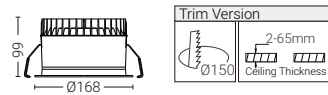

3000K-3500K-4000K CCT Switchable Version

3000K

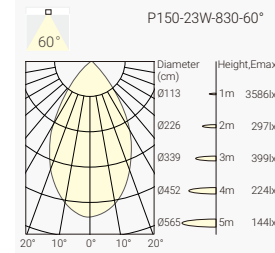

Finish

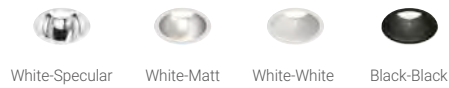

Order Info (PASSION 150 in White-Specular Finish as an Example)

LED Power	System Power	LED Voltage	LED Current	CRI	CCT	Beam LED Output	System Output	Code
16W	18W	33V	500mA	80	3000K	60° 3100lm	2450lm	PAN6-8306016N-WS
					4000K	60° 3400lm	2600lm	PAN6-8406016N-WS
23W	25W	33V	700mA	80	3000K	60° 3900lm	3350lm	PAN6-8306023N-WS
					4000K	60° 4200lm	3500lm	PAN6-8406023N-WS
18W	20W	33V	500mA	80	3000K-3500K-4000K	60° 3100lm	Max.2450lm	PAN6-8S306018N-WS
25W	28W	33V	700mA	80	3000K-3500K-4000K	60° 3900lm	Max.3350lm	PAN6-8S306025N-WS

Code Remark: N=N(No Driver) F=F(ON-OFF) P=P(Phase Dim) A=A(1-10V Dim) D=D(DALI Dim)

Coding

Model	CRI/ CCT	Beam Angle	LED Power	Control	Trim Finish-Reflector Color	Accessory
PAN6	830	60	16	N	WS	
PASSION 150	CRI>80/ 3000K	60°	16W	No Driver	White-Specular	
	840		23	F	WM	
	CRI>80/ 4000K		23W	On-Off	White-Matt	
	8S3			P	WW	
	CRI>80/ 3000K-3500K-4000K			Phase Dim	White-White	
	930			A	BB	
	CRI>90/ 3000K			1-10V Dim	Black-Black	
	940			D		
	CRI>90/ 4000K			DALI Dim		
	9S3					
	CRI>90/ 3000K-3500K-4000K					

PASSION 200 – The High Efficiency Fixed Downlight

NEW

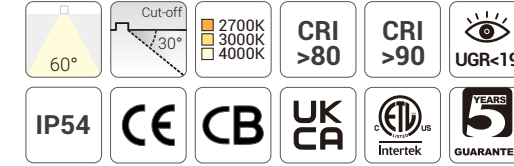

Quick Info

- Ceiling Cut-out: Ø175mm-200mm
- LED: 23W, 30W, CRI>80, CRI>90
- CCT: Single 3000K, 4000K or 3000K-3500K-4000K CCT Switchable
- Beam Angle: 60° within Opal Cover
- Lumen Output: Up to 4600lm System Luminous Flux
- IP Class: IP54 from Front
- LED Driver: On-Off, Phase Dim, 1-10V Dim, DALI Dim, Casambi Wireless Dim

Light Distribution

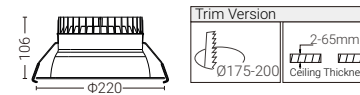

3000K-3500K-4000K CCT Switchable Version

3000K

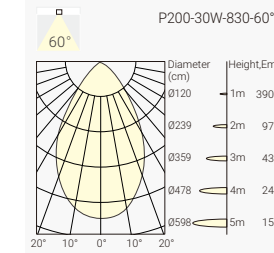

Finish

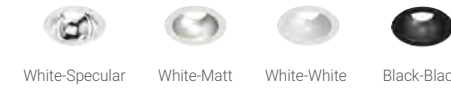

Order Info (PASSION 200 in White-Specular Finish as an Example)

LED Power	System Power	LED Voltage	LED Current	CRI	CCT	Beam LED Output	System Output	Code
23W	25W	33V	700mA	80	3000K	60° 3900lm	3500lm	PAN8-8306023N-WS
					4000K	60° 4200lm	3650lm	PAN8-8406023N-WS
30W	33W	33V	900mA	80	3000K	60° 5000lm	4350lm	PAN8-8306030N-WS
					4000K	60° 5300lm	4600lm	PAN8-8406030N-WS
25W	28W	33V	700mA	80	3000K-3500K-4000K	60° 3900lm	Max.3550lm	PAN8-8S306025N-WS
30W	33W	33V	900mA	80	3000K-3500K-4000K	60° 5000lm	Max.4350lm	PAN8-8S306030N-WS

Code Remark: N=N(No Driver) F=F(ON-OFF) P=P(Phase Dim) A=A(1-10V Dim) D=D(DALI Dim)

Coding

Model	CRI/ CCT	Beam Angle	LED Power	Control	Trim Finish-Reflector Color	Accessory
PAN8	830	60	23	N	WS	
PASSION 200	CRI>80/ 3000K	60°	23W	No Driver	White-Specular	
	840		30	F	WM	
	CRI>80/ 4000K		30W	On-Off	White-Matt	
	8S3			P	WW	
	CRI>80/ 3000K-3500K-4000K			Phase Dim	White-White	
	930			A	BB	
	CRI>90/ 3000K			1-10V Dim	Black-Black	
	940			D		
	CRI>90/ 4000K			DALI Dim		
	9S3					
	CRI>90/ 3000K-3500K-4000K					

CLUB

Modular Downlight System

Power from 6W to 18W

Round & Square, Trim & Trimless

Various Trims for Different Applications





Project: Hotel Bellune, Paris, France



Project: Pavilion Damansara, Malaysia



Project: Private Residence, Schuettorf, Germany



- The NEKO M1, M2, M3 & M4 LED Modules is a perfect replacement for MR16 halogen modules.
- Smart and elegant design.
- Versatile for downlight and spotlight applications.
- Uniform color for all LED modules within 3 MacAdam steps.
- You can use NEKO LED modules in various fixture designs with no color variability.
- Outstanding lumen output, excellent lumen maintenance.
- 50,000-hour lifetime eliminates frequent re-lamping.
- NEKO 5-Year Quality Guarantee

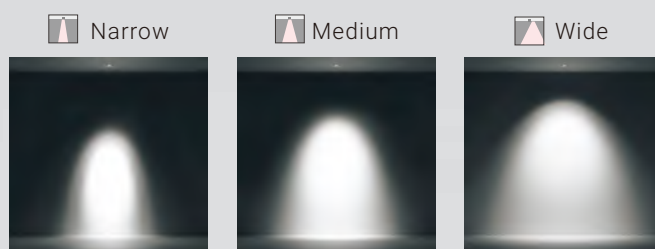

Verschiedene Abstrahlwinkel für architektonische Designs
Three beam angles for various architectural design requirements.





- The NEKO M4 Pro LED module is a perfect replacement for MR16 halogen modules.
- Smart and elegant design.
- Versatile for downlight and spotlight applications.
- Uniform color for all LED modules within 2 MacAdam steps.
- You can use NEKO M4 Pro LED modules in various fixture designs with no color variability.
- Outstanding lumen output, excellent lumen maintenance.
- 50,000-hour lifetime eliminates frequent re-lamping.
- NEKO 5-Year Quality Guarantee

Architectural 10°

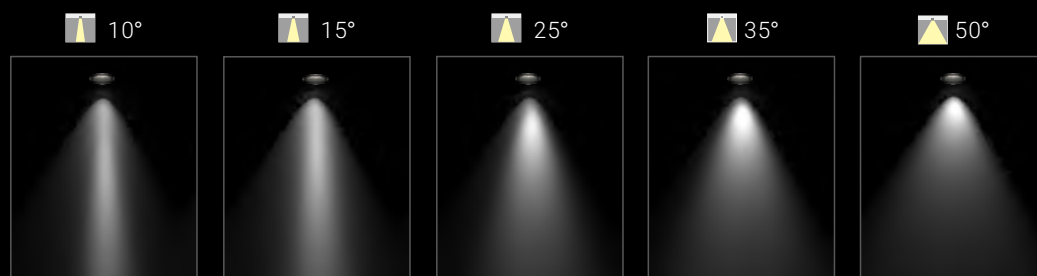

Verschiedene Abstrahlwinkel für architektonische Designs
Five beam angles for various architectural design requirements.



CLUB – M1 LED Module

NEW

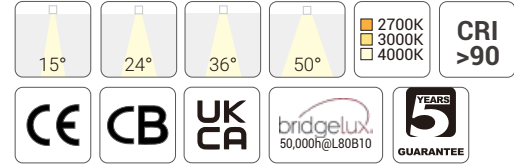

Quick Info

- Fit with CLUB Series Trims
- Bridgelux LED: 6W, 9W, CRI>90
- CCT: 2700K, 3000K, 4000K Available as Standard
- Beam Angle: 15°, 24°, 36°, 50°
- Lumen Output: Up to 950lm System Luminous Flux
- IP Class: Module IP20
- LED Driver: On-Off, Phase Dim, 1-10V Dim, DALI Dim, Casambi Wireless Dim

Light Distribution

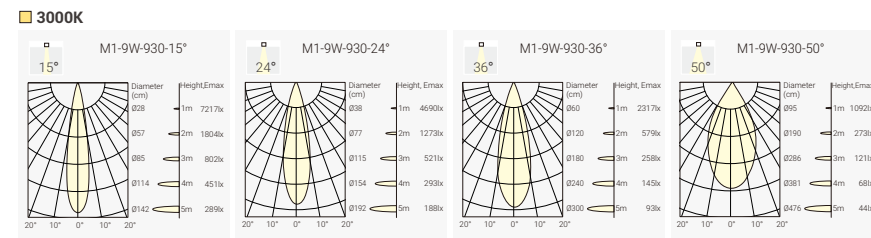

Order Info

LED Power	System Power	LED Voltage	LED Current	CRI	CCT	Beam	LED Output	System Output	Code						
9W	11W	36V	250mA	90	2700K	15°	950lm	720lm	M1-9271509N-NN						
						24°	950lm	800lm	M1-9272409N-NN						
						36°	950lm	800lm	M1-9273609N-NN						
						50°	950lm	800lm	M1-9275009N-NN						
						3000K	15°	1050lm	750lm	M1-9301509N-NN					
							24°	1050lm	850lm	M1-9302409N-NN					
							36°	1050lm	850lm	M1-9303609N-NN					
							50°	1050lm	850lm	M1-9305009N-NN					
						4000K	15°	1150lm	900lm	M1-9401509N-NN					
							24°	1150lm	950lm	M1-9402409N-NN					
							36°	1150lm	950lm	M1-9403609N-NN					
							50°	1150lm	950lm	M1-9405009N-NN					
						6W	8W	36V	180mA	90	2700K	15°	720lm	520lm	M1-9271506N-NN
												24°	720lm	550lm	M1-9272406N-NN
												36°	720lm	550lm	M1-9273606N-NN
												50°	720lm	550lm	M1-9275006N-NN
3000K	15°	750lm	570lm	M1-9301506N-NN											
	24°	750lm	600lm	M1-9302406N-NN											
	36°	750lm	600lm	M1-9303606N-NN											
	50°	750lm	600lm	M1-9305006N-NN											
4000K	15°	800lm	620lm	M1-9401506N-NN											
	24°	800lm	650lm	M1-9402406N-NN											
	36°	800lm	650lm	M1-9403606N-NN											
	50°	800lm	650lm	M1-9405006N-NN											

Code Remark: N=N(No Driver) F=F(ON-OFF) P=P(Phase Dim) A=A(1-10V Dim) D=D(DALI Dim)

CLUB – M2 LED Module

NEW

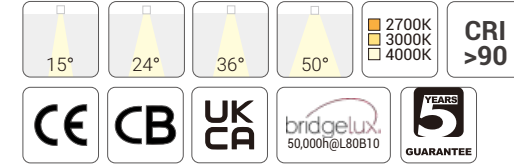

Quick Info

- Fit with CLUB Series Trims
- Bridgelux LED: 9W, 13W, CRI>90
- CCT: 2700K, 3000K, 4000K Available as Standard
- Beam Angle: 15°, 24°, 36°, 50°
- Lumen Output: Up to 1250lm System Luminous Flux
- IP Class: Module IP20
- LED Driver: On-Off, Phase Dim, 1-10V Dim, DALI Dim, Casambi Wireless Dim

Light Distribution

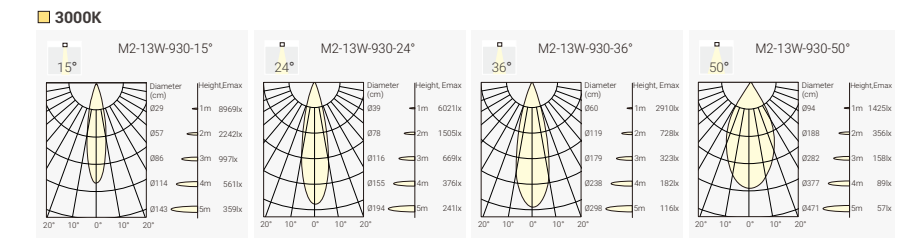

Order Info

LED Power	System Power	LED Voltage	LED Current	CRI	CCT	Beam	LED Output	System Output	Code						
13W	15W	36V	350mA	90	2700K	15°	1300lm	900lm	M2-9271513N-NN						
						24°	1300lm	980lm	M2-9272413N-NN						
						36°	1300lm	980lm	M2-9273613N-NN						
						50°	1300lm	950lm	M2-9275013N-NN						
						3000K	15°	1450lm	950lm	M2-9301513N-NN					
							24°	1450lm	1150lm	M2-9302413N-NN					
							36°	1450lm	1150lm	M2-9303613N-NN					
							50°	1450lm	1100lm	M2-9305013N-NN					
						4000K	15°	1600lm	1100lm	M2-9401513N-NN					
							24°	1600lm	1250lm	M2-9402413N-NN					
							36°	1600lm	1250lm	M2-9403613N-NN					
							50°	1600lm	1200lm	M2-9405013N-NN					
						9W	11W	36V	250mA	90	2700K	15°	950lm	720lm	M2-9271509N-NN
												24°	950lm	800lm	M2-9272409N-NN
												36°	950lm	800lm	M2-9273609N-NN
												50°	950lm	800lm	M2-9275009N-NN
3000K	15°	1050lm	780lm	M2-9301509N-NN											
	24°	1050lm	850lm	M2-9302409N-NN											
	36°	1050lm	850lm	M2-9303609N-NN											
	50°	1050lm	800lm	M2-9305009N-NN											
4000K	15°	1150lm	850lm	M2-9401509N-NN											
	24°	1150lm	950lm	M2-9402409N-NN											
	36°	1150lm	950lm	M2-9403609N-NN											
	50°	1150lm	900lm	M2-9405009N-NN											

Code Remark: N=N(No Driver) F=F(ON-OFF) P=P(Phase Dim) A=A(1-10V Dim) D=D(DALI Dim)

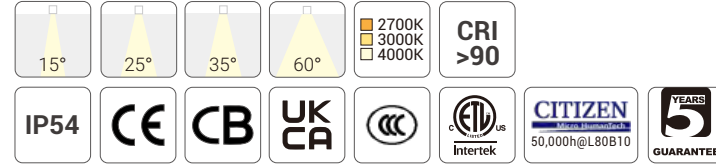
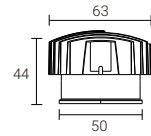

Quick Info

- Fit with CLUB Series Trims
- CITIZEN LED: 7.5W, 11W, CRI>90
- CCT: 2700K, 3000K, 4000K Available as Standard
- Beam Angle: 15°, 25°, 35°, 60°
- Lumen Output: Up to 1000lm System Luminous Flux
- IP Class: Module IP54
- LED Driver: On-Off, Phase Dim, 1-10V Dim, DALI Dim, Casambi Wireless Dim

Light Distribution

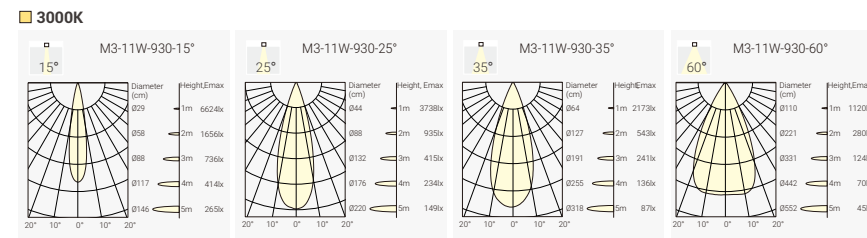

Order Info

LED Power	System Power	LED Voltage	LED Current	CRI	CCT	Beam	LED Output	System Output	Code	
11W	13W	31V	350mA	90	2700K	15°	1000lm	900lm	M3-9271511N-NN	
						25°	1000lm	900lm	M3-9272511N-NN	
						35°	1000lm	900lm	M3-9273511N-NN	
						60°	1000lm	900lm	M3-9276011N-NN	
						3000K	15°	1100lm	950lm	M3-9301511N-NN
							25°	1100lm	950lm	M3-9302511N-NN
							35°	1100lm	950lm	M3-9303511N-NN
							60°	1100lm	950lm	M3-9306011N-NN
						4000K	15°	1200lm	1000lm	M3-9401511N-NN
							25°	1200lm	1000lm	M3-9402511N-NN
							35°	1200lm	1000lm	M3-9403511N-NN
							60°	1200lm	1000lm	M3-9406011N-NN
7.5W	9W	31V	250mA	90	2700K	15°	850lm	650lm	M3-9271508N-NN	
						25°	850lm	650lm	M3-9272508N-NN	
						35°	850lm	650lm	M3-9273508N-NN	
						60°	850lm	650lm	M3-9276008N-NN	
						3000K	15°	900lm	700lm	M3-9301508N-NN
							25°	900lm	700lm	M3-9302508N-NN
							35°	900lm	700lm	M3-9303508N-NN
							60°	900lm	700lm	M3-9306008N-NN
						4000K	15°	950lm	750lm	M3-9401508N-NN
							25°	950lm	750lm	M3-9402508N-NN
							35°	950lm	750lm	M3-9403508N-NN
							60°	950lm	750lm	M3-9406008N-NN

Code Remark: N=N(No Driver) F=F(ON-OFF) P=P(Phase Dim) A=A(1-10V Dim) D=D(DALI Dim)

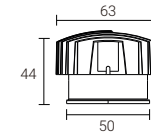

Quick Info

- Fit with CLUB Series Trims
- Bridgelux LED: 12W, CRI>95
- CCT: Dim to Warm 1800K-3000K
- Beam Angle: 35°, 60°
- Lumen Output: Up to Max.850lm System Luminous Flux
- IP Class: Module IP54
- LED Driver: Phase Dim, 1-10V Dim, DALI Dim, Casambi Wireless Dim

Light Distribution

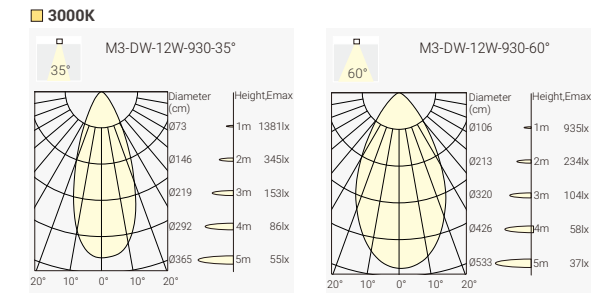

Order Info

LED Power	System Power	LED Voltage	LED Current	CRI	CCT	Beam	LED Output	System Output	Code
12W	14W	34V	350mA	95	1800K-3000K	35°	1100lm	Max.850lm	M3-9D33512N-NN
						60°	1100lm	Max.850lm	M3-9D36012N-NN

Code Remark: N=N(No Driver) P=P(Phase Dim) A=A(1-10V Dim) D=D(DALI Dim)



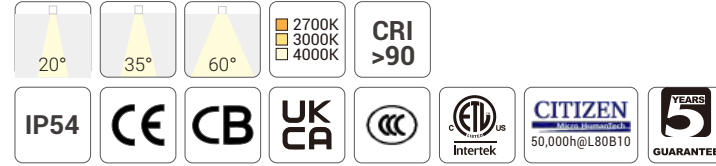

Quick Info

- Fit with CLUB Series Trims
- CITIZEN LED: 9W, 13W, 18W, CRI>90
- CCT: 2700K, 3000K, 4000K Available as Standard
- Beam Angle: 20°, 35°, 60°
- Lumen Output: Up to 1700lm System Luminous Flux
- IP Class: Module IP54
- LED Driver: On-Off, Phase Dim, 1-10V Dim, DALI Dim, Casambi Wireless Dim

Light Distribution

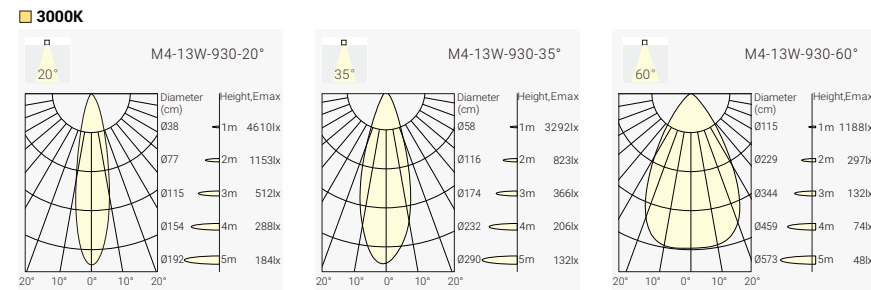

Order Info

LED Power	System Power	LED Voltage	LED Current	CRI	CCT	Beam	LED Output	System Output	Code						
13W	15W	36V	350mA	90	2700K	20°	1300lm	1100lm	M4-9272013N-NN						
						35°	1300lm	1100lm	M4-9273513N-NN						
						60°	1300lm	1100lm	M4-9276013N-NN						
						3000K	20°	1400lm	1200lm	M4-9302013N-NN					
							35°	1400lm	1200lm	M4-9303513N-NN					
							60°	1400lm	1200lm	M4-9306013N-NN					
						4000K	20°	1500lm	1300lm	M4-9402013N-NN					
							35°	1500lm	1300lm	M4-9403513N-NN					
							60°	1500lm	1300lm	M4-9406013N-NN					
						9W	11W	36V	250mA	90	2700K	20°	900lm	1100lm	M4-9272009N-NN
												35°	900lm	1100lm	M4-9273509N-NN
												60°	900lm	1100lm	M4-9276009N-NN
3000K	20°	1000lm	1200lm	M4-9302009N-NN											
	35°	1000lm	1200lm	M4-9303509N-NN											
	60°	1000lm	1200lm	M4-9306009N-NN											
4000K	20°	1100lm	1300lm	M4-9402009N-NN											
	35°	1100lm	1300lm	M4-9403509N-NN											
	60°	1100lm	1300lm	M4-9406009N-NN											
18W	21W	36V	500mA	90	2700K							20°	1800lm	1500lm	M4-9272018N-NN
												35°	1800lm	1500lm	M4-9273518N-NN
												60°	1800lm	1500lm	M4-9276018N-NN
						3000K	20°	1900lm	1600lm	M4-9302018N-NN					
							35°	1900lm	1600lm	M4-9303518N-NN					
							60°	1900lm	1600lm	M4-9306018N-NN					
						4000K	20°	2000lm	1700lm	M4-9402018N-NN					
							35°	2000lm	1700lm	M4-9403518N-NN					
							60°	2000lm	1700lm	M4-9406018N-NN					

Code Remark: N=N(No Driver) F=F(ON-OFF) P=P(Phase Dim) A=A(1-10V Dim) D=D(DALI Dim)

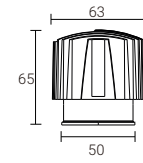

Quick Info

- Fit with CLUB Series Trims
- Bridgelux LED: 12W, CRI>95
- CCT: Dim to Warm 1800K-3000K
- Beam Angle: 35°, 60°
- Lumen Output: Up to Max.850lm System Luminous Flux
- IP Class: Module IP54
- LED Driver: Phase Dim, 1-10V Dim, DALI Dim, Casambi Wireless Dim

Light Distribution

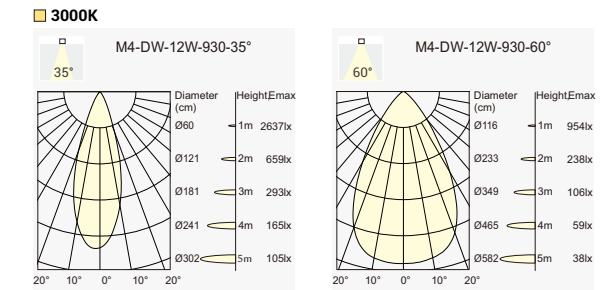

Order Info

LED Power	System Power	LED Voltage	LED Current	CRI	CCT	Beam	LED Output	System Output	Code
12W	14W	34V	350mA	95	1800K-3000K	35°	1100lm	Max.850lm	M4-9D33512N-NN
						60°	1100lm	Max.850lm	M4-9D36012N-NN

Code Remark: N=N(No Driver) P=P(Phase Dim) A=A(1-10V Dim) D=D(DALI Dim)



M4 Pro LED Module

LED Power: 7W/ 9W/ 12W/ 13W/ 18W

LED Chip: Bridgelux CRI>97, R9=95, 2-step SDCM

Beam Angle: 10°/ 15°/ 25°/ 35°/ 50°

Standard CCT: 2700K/ 3000K/ 3500K/ 4000K

Optional CCT: 1800K-3000K Warm Dim/ 2700K-6500K Tunable White

Optional Accessory: Honeycomb/ Diffusion Filter/ Linear Spread Filter

Single Asymmetric Filter/ Double Asymmetric Filter

M4 Pro LED Module



Accessory:



Honeycomb



Diffusion Filter



Linear Spread Filter



Single Asymmetric Filter



Double Asymmetric Filter

CLUB Trim:



Honeycomb Effect

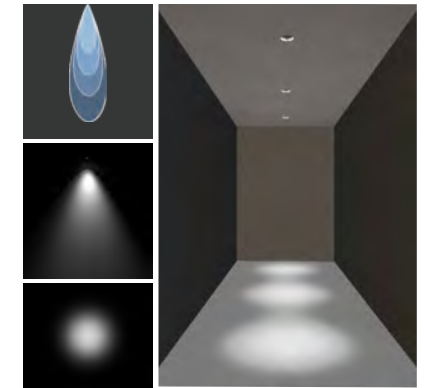

Diffusion Filter Effect

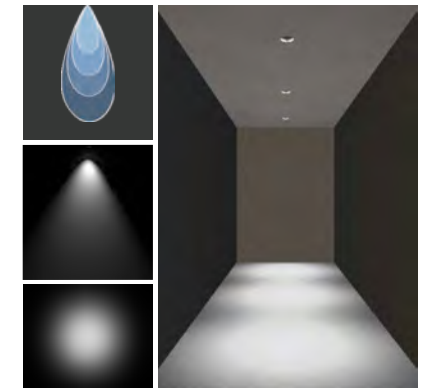

Linear Spread Filter Effect

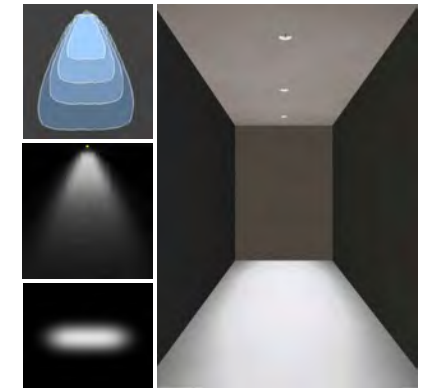

Single Asymmetric Filter Effect

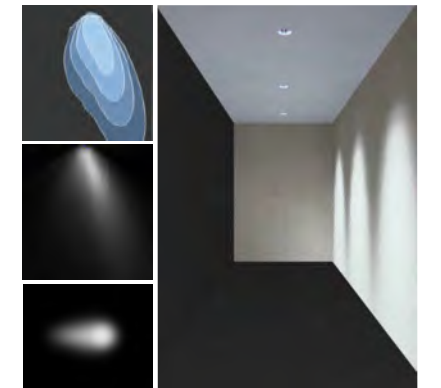

Double Asymmetric Filter Effect

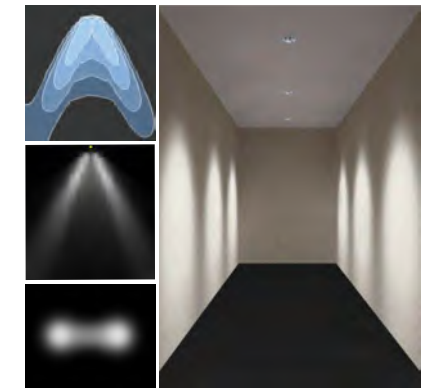

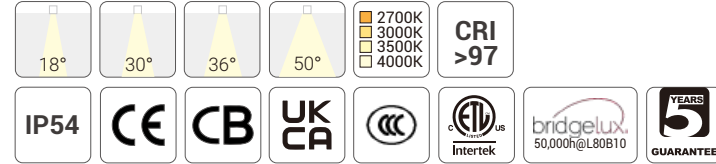

Quick Info

- Fit with CLUB Series Trims
- Bridgelux LED: 13W, 18W, CRI>97
- CCT: 2700K, 3000K, 3500K, 4000K Available as Standard
- Beam Angle: 15°/18°, 25°/30°, 35°/36°, 50°
- Lumen Output: Up to 1700lm System Luminous Flux
- IP Class: Module IP54
- LED Driver: On-Off, Phase Dim, 1-10V Dim, DALI Dim, Casambi Wireless Dim

Light Distribution

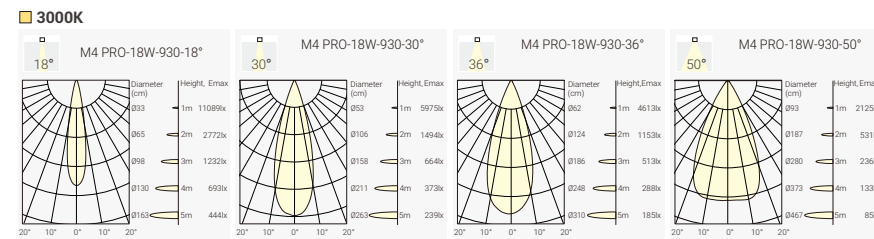

Order Info

LED Power	System Power	LED Voltage	LED Current	CRI	CCT	Beam	LED Output	System Output	Code						
13W	15W	36V	350mA	97	2700K	15°	1300lm	1050lm	M4P3-0271513N-NN						
						25°	1300lm	1050lm	M4P3-0272513N-NN						
						35°	1300lm	1050lm	M4P3-0273513N-NN						
						50°	1300lm	1000lm	M4P3-0276013N-NN						
						3000K	15°	1400lm	1100lm	M4P3-0301513N-NN					
							25°	1400lm	1100lm	M4P3-0302513N-NN					
							35°	1400lm	1100lm	M4P3-0303513N-NN					
							50°	1400lm	1050lm	M4P3-0306013N-NN					
						3500K	15°	1450lm	1150lm	M4P3-0351513N-NN					
							25°	1450lm	1150lm	M4P3-0352513N-NN					
							35°	1450lm	1150lm	M4P3-0353513N-NN					
							50°	1450lm	1100lm	M4P3-0356013N-NN					
						4000K	15°	1500lm	1200lm	M4P3-0401513N-NN					
							25°	1500lm	1200lm	M4P3-0402513N-NN					
							35°	1500lm	1200lm	M4P3-0403513N-NN					
							50°	1500lm	1150lm	M4P3-0406013N-NN					
						18W	21W	36V	500mA	97	2700K	18°	1900lm	1500lm	M4P4-0271818N-NN
												30°	1900lm	1500lm	M4P4-0273018N-NN
												36°	1900lm	1500lm	M4P4-0273618N-NN
												50°	1900lm	1400lm	M4P4-0275018N-NN
3000K	18°	2000lm	1600lm	M4P4-0301818N-NN											
	30°	2000lm	1600lm	M4P4-0303018N-NN											
	36°	2000lm	1600lm	M4P4-0303618N-NN											
	50°	2000lm	1500lm	M4P4-0305018N-NN											
3500K	18°	2150lm	1650lm	M4P4-0351818N-NN											
	30°	2150lm	1650lm	M4P4-0353018N-NN											
	36°	2150lm	1650lm	M4P4-0353618N-NN											
	50°	2150lm	1500lm	M4P4-0355018N-NN											
4000K	18°	2200lm	1700lm	M4P4-0401818N-NN											
	30°	2200lm	1700lm	M4P4-0403018N-NN											
	36°	2200lm	1700lm	M4P4-0403618N-NN											
	50°	2200lm	1650lm	M4P4-0405018N-NN											

Code Remark: N=(No Driver) F=(ON-OFF) P=(Phase Dim) A=(1-10V Dim) D=(DALI Dim)

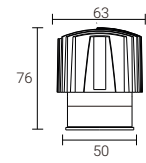

Quick Info

- Fit with CLUB Series Trims
- Bridgelux LED: 7W, CRI>97
- CCT: 2700K, 3000K, 3500K, 4000K Available as Standard
- Beam Angle: 10°
- Lumen Output: Up to 600lm System Luminous Flux
- IP Class: Module IP54
- LED Driver: On-Off, Phase Dim, 1-10V Dim, DALI Dim, Casambi Wireless Dim

Light Distribution

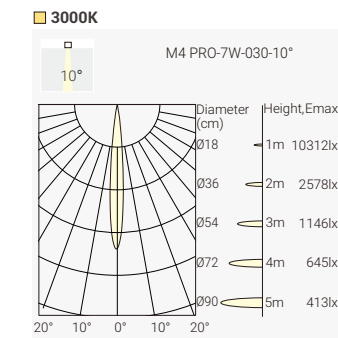

Order Info

LED Power	System Power	LED Voltage	LED Current	CRI	CCT	Beam	LED Output	System Output	Code
7W	9W	36V	200mA	97	2700K	10°	650lm	500lm	M4P1-0271007N-NN
					3000K	10°	700lm	550lm	M4P1-0301007N-NN
					3500K	10°	725lm	570lm	M4P1-0351007N-NN
					4000K	10°	750lm	600lm	M4P1-0401007N-NN

Code Remark: N=(No Driver) F=(ON-OFF) P=(Phase Dim) A=(1-10V Dim) D=(DALI Dim)

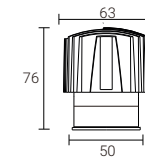

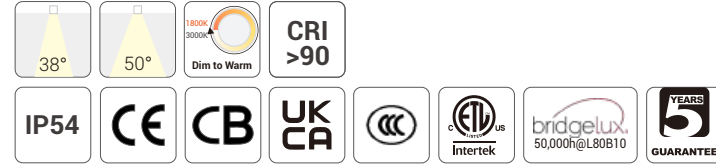

Quick Info

- Fit with CLUB Series Trims
- Bridgelux LED: 12W, CRI>90
- CCT: Dim to Warm 1800K-3000K
- Beam Angle: 38°, 50°
- Lumen Output: Up to 900lm System Luminous Flux
- IP Class: Module IP54
- LED Driver: Phase Dim, 1-10V Dim, DALI Dim, Casambi Wireless Dim

Light Distribution

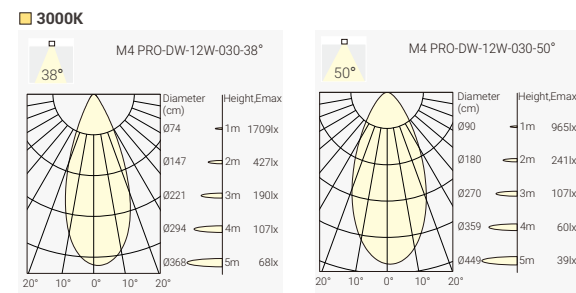

Order Info

LED Power	System Power	LED Voltage	LED Current	CRI	CCT	Beam	LED Output	System Output	Code
12W	14W	34V	350mA	90	1800K-3000K	38°	1100lm	Max. 900lm	M4P5-0D33812N-NN
						50°	1100lm	Max. 850lm	M4P5-0D35012N-NN

Code Remark: N=N(No Driver) P=P(Phase Dim) A=A(1-10V Dim) D=D(DALI Dim)



Quick Info

- Fit with CLUB Series Trims
- Bridgelux LED: 9W, 13W, CRI>90,
- CCT: Tunable White 2700K-6500K
- Beam Angle: 20°, 35°, 50°
- Lumen Output: Up to 1100lm System Luminous Flux
- IP Class: Module IP54
- LED Driver: DALI DT8 Dim

Light Distribution

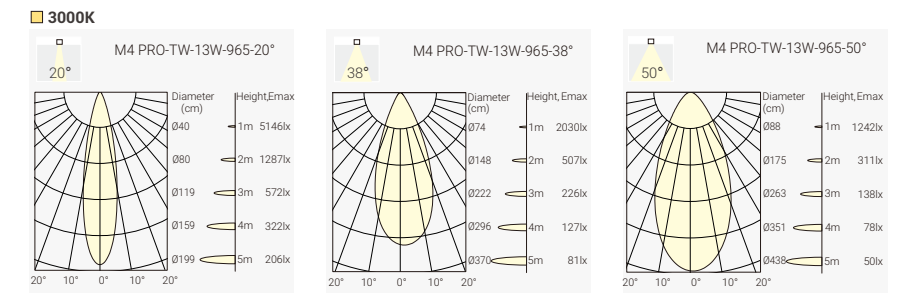

Order Info

LED Power	System Power	LED Voltage	LED Current	CRI	CCT	Beam	System Output	Code
9W	11W	36V	250mA	90	2700K-6500K	20°	700lm-850lm	M4P6-9TW2009N-NN
						38°	700lm-850lm	M4P6-9TW3809N-NN
						50°	700lm-850lm	M4P6-9TW5009N-NN
						@2700K	700lm	
						@3000K	730lm	
						@4000K	800lm	
@5000K	850lm							
@6500K	850lm							
13W	15W	36V	350mA	90	2700K-6500K	20°	900lm-1100lm	M4P6-9TW2013N-NN
						38°	900lm-1100lm	M4P6-9TW3813N-NN
						50°	850lm-1050lm	M4P6-9TW5013N-NN
						@2700K	900lm	
						@3000K	950lm	
						@4000K	1000lm	
@5000K	1100lm							
@6500K	1100lm							

Code Remark: N=N(No Driver) D=D(DALI DT8 Dim)



CLUB – Modular Downlight System

- Perfect choice for specified architectural projects
- Compatible with Mr16 and LED Modules
- Wide range of design variants for different applications
- Available in trimless versions
- Decorative rings painted in a variety of colors (black, white, marble, wood, etc.)
- Magnetic design for changing decorative ring without any tools

NEW

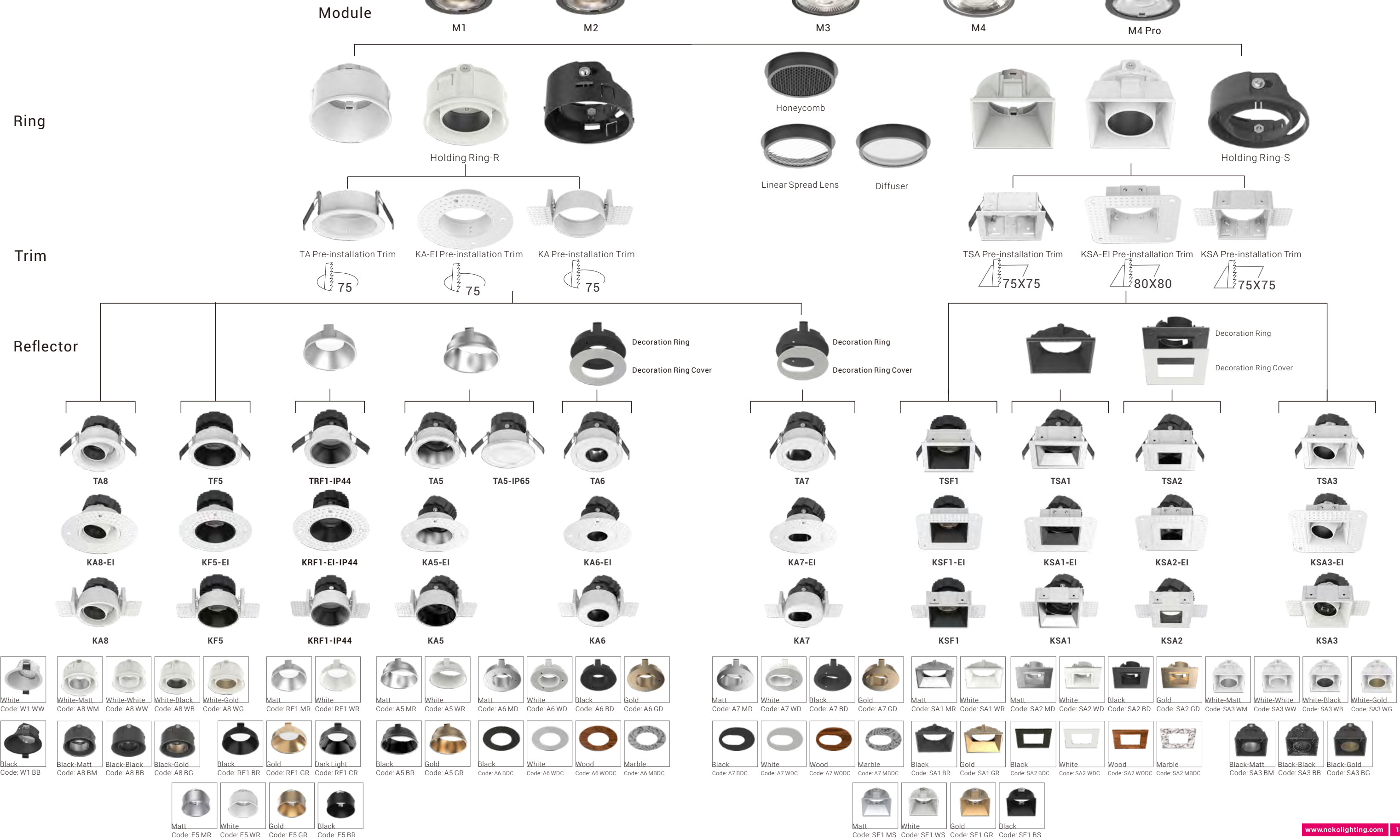

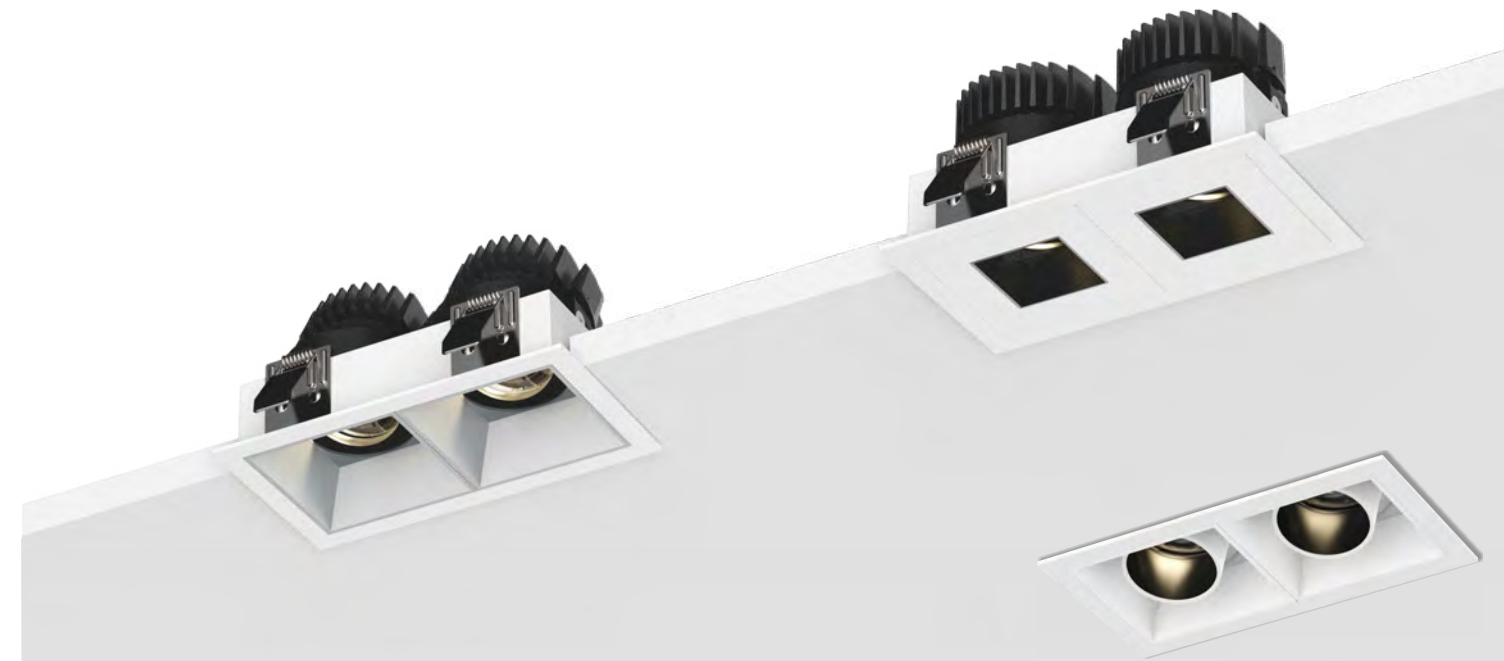
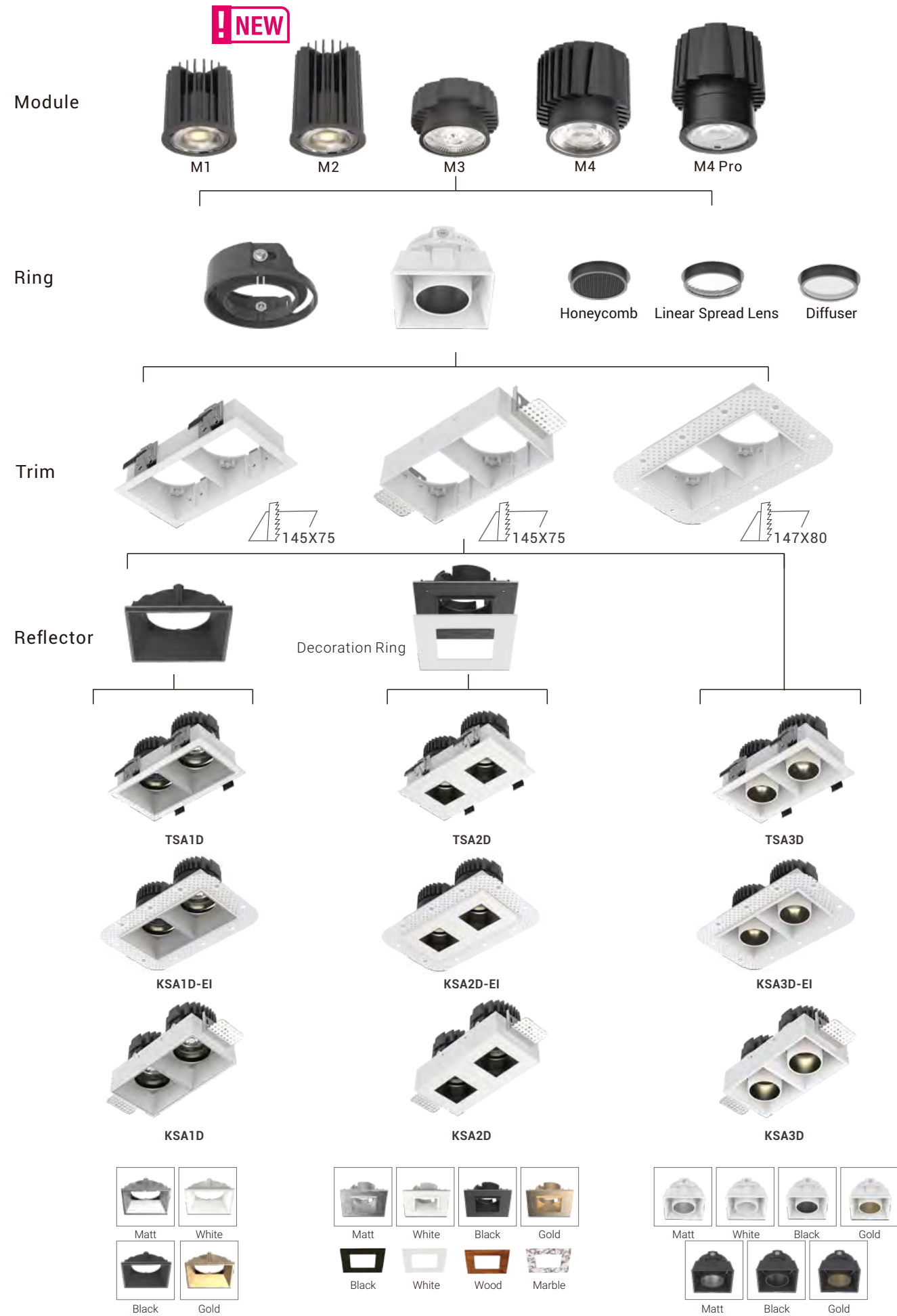



TF5 TA5 TA6 TA7 TA8



TSF1 TSA1 TSA2 TSA3

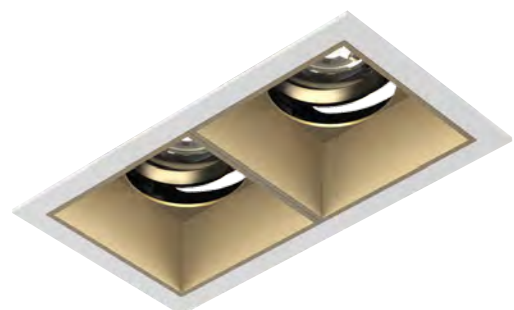

TSA1D

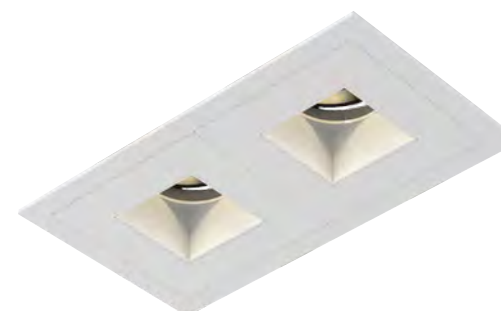
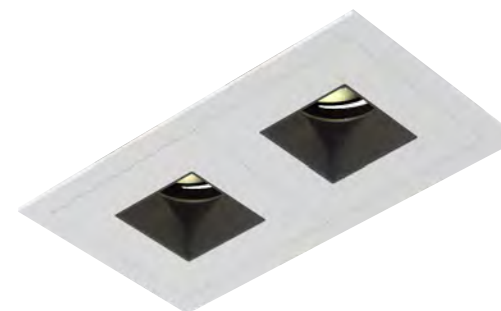
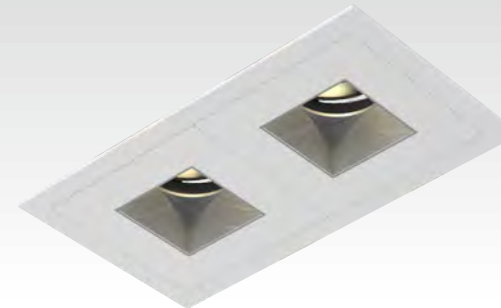

TSA2D

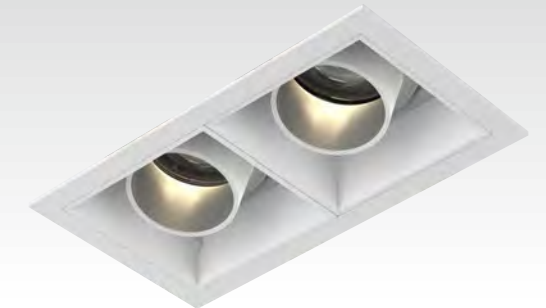

TSA3D



NEW TF5

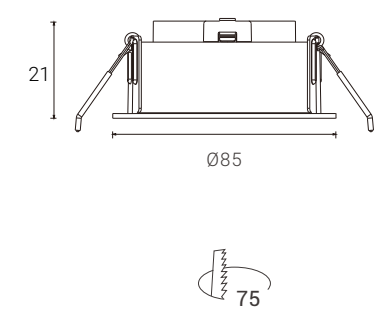



TRF1-IP44

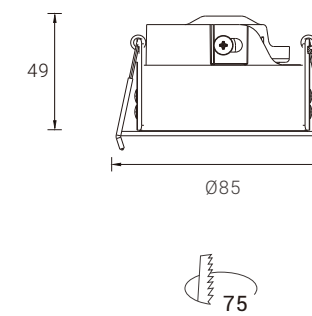



TA5-IP65

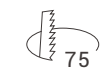
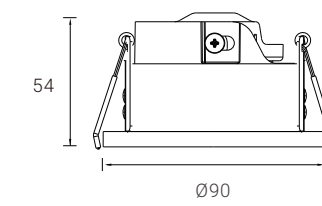



NEW TSF1

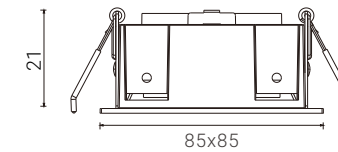
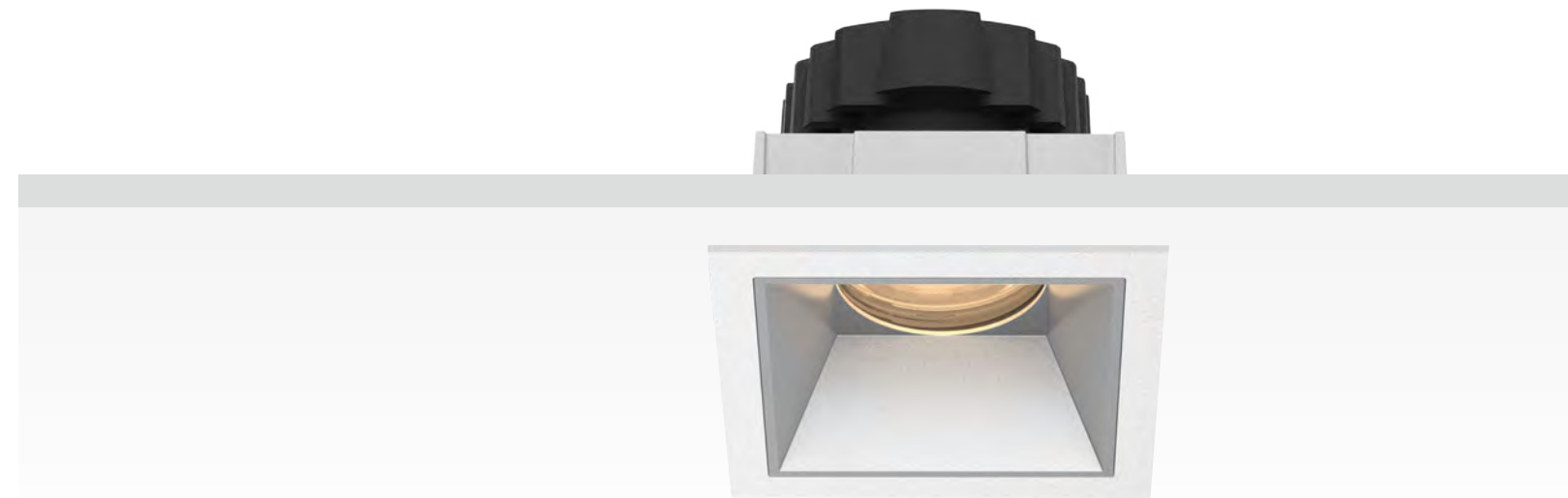

75X75

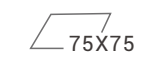
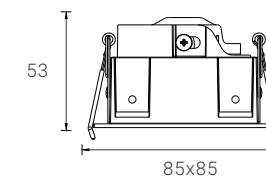
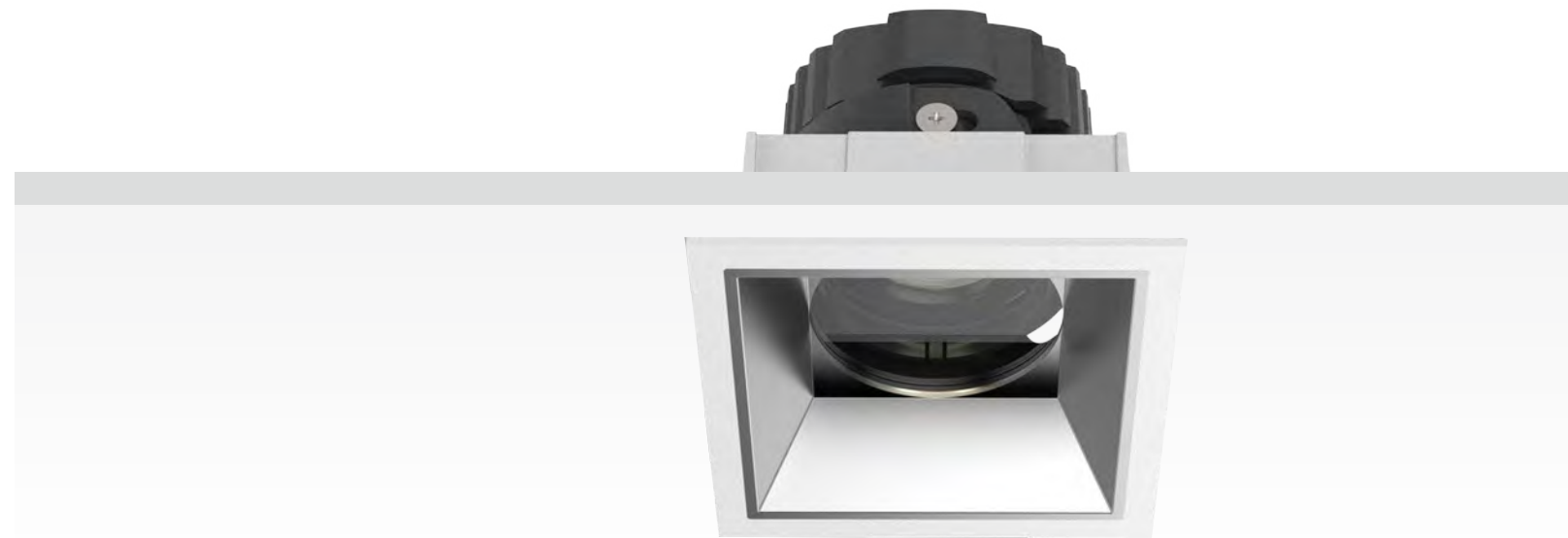



KA5



KA8



KF5

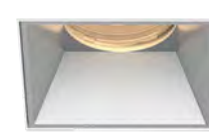

KSF1



KSA1



KSA1D-EI



KSA3



KA6



KSA2



KSA2D-EI



KA7



KSA3D-EI

Installation Trimless Trims

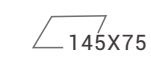
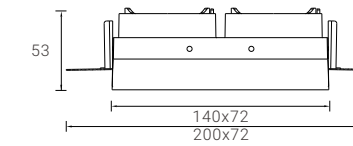
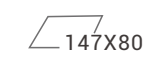
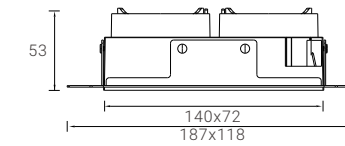
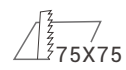
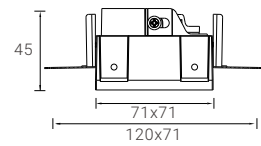
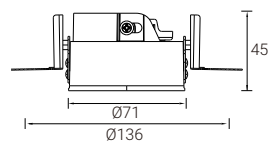

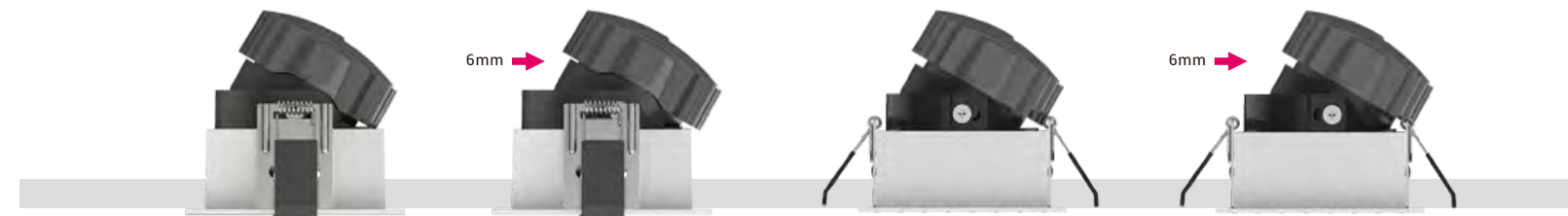
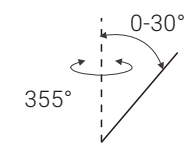
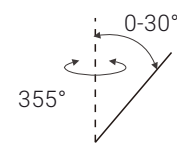

TSA1



TSA1D

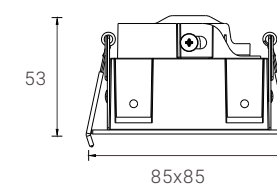

75X75

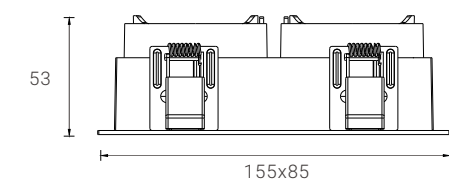

145X75

TA5

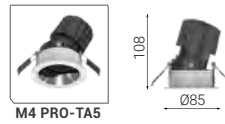
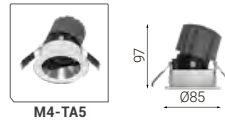

TA6

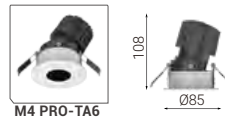
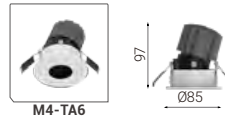
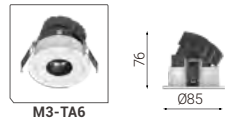

TA7

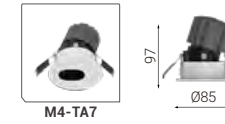
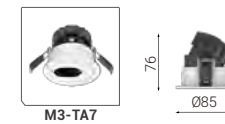

TA8

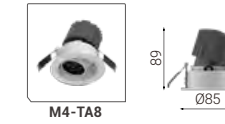
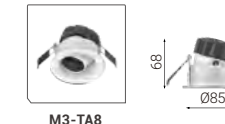

KA5-EI

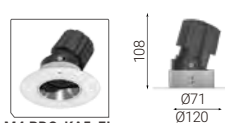
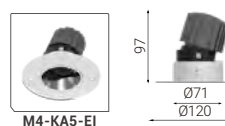
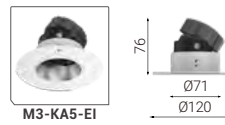

KA6-EI

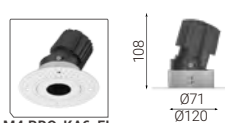
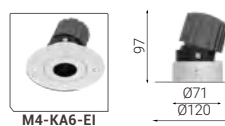
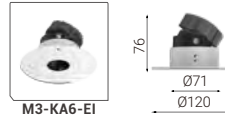

KA7-EI

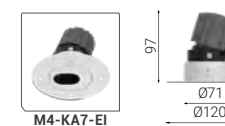
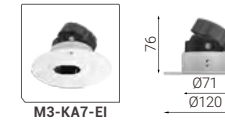

KA8-EI

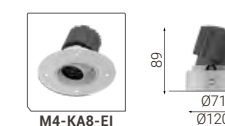
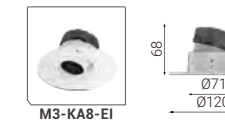

KA5

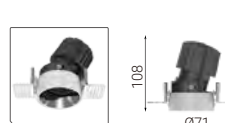
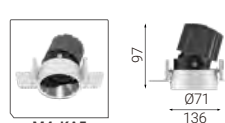
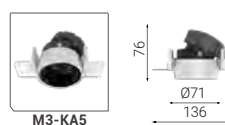

KA6

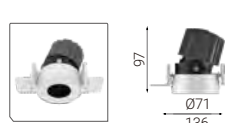
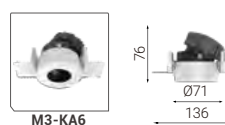

KA7

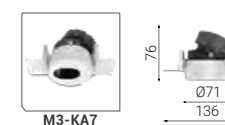

KA8

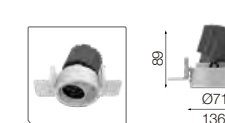
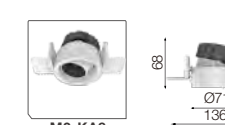

NEW

TF5

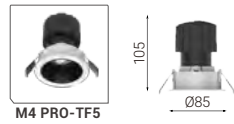
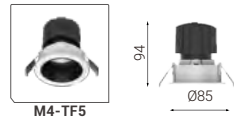
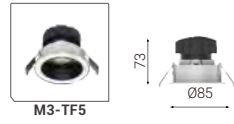

TRF1/ TRF1-IP44

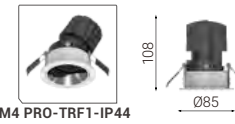
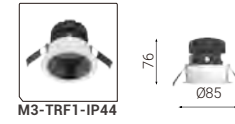

TA5-IP65

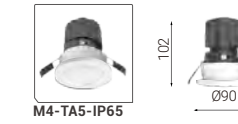
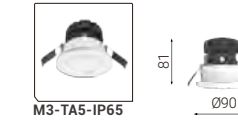

NEW

KF5-EI

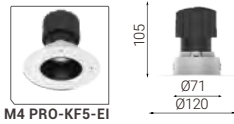
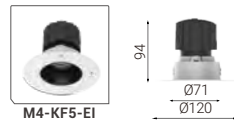

KRF1-EI/ KRF1-EI-IP44

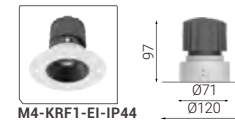
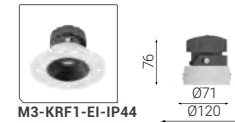

NEW

KF5

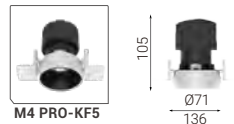
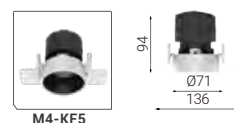
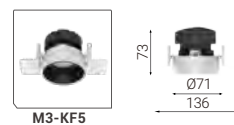

KRF1/ KRF1-IP44

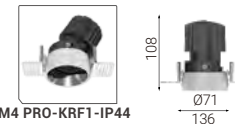
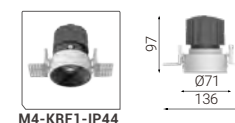
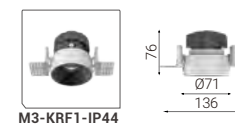

NEW

TSF1

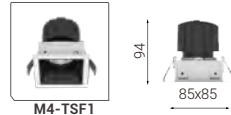

TSA1

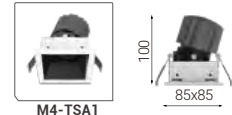
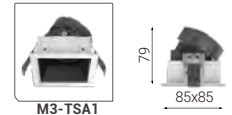

TSA2

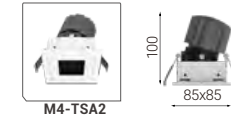
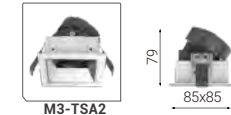

TSA3

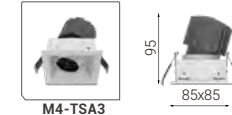
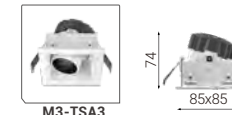

NEW

KSF1-EI

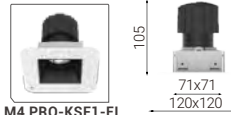
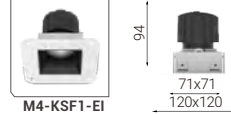

KSA1-EI

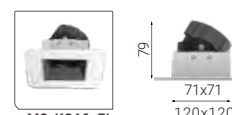

KSA2-EI

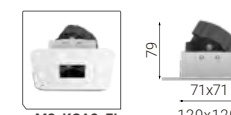

KSA3-EI

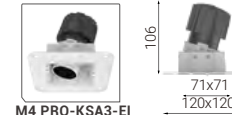
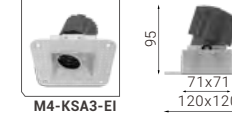

NEW

KSF1

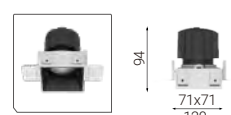
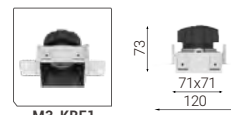

KSA1

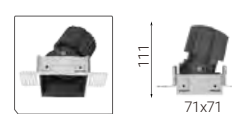
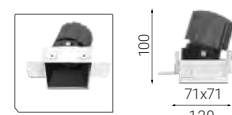
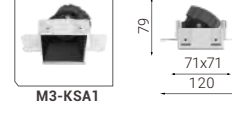

KSA2

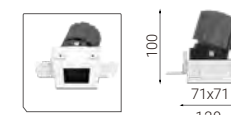
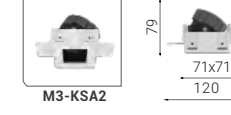

KSA3

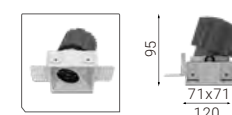

TSA1D

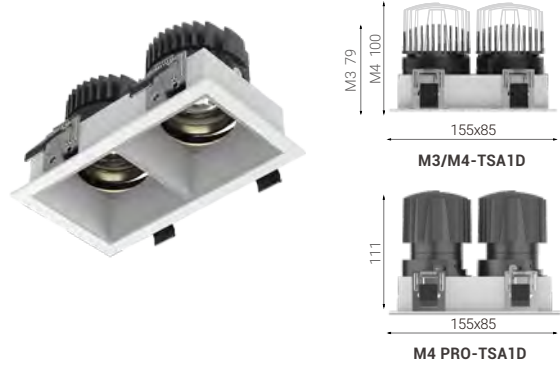

TSA2D

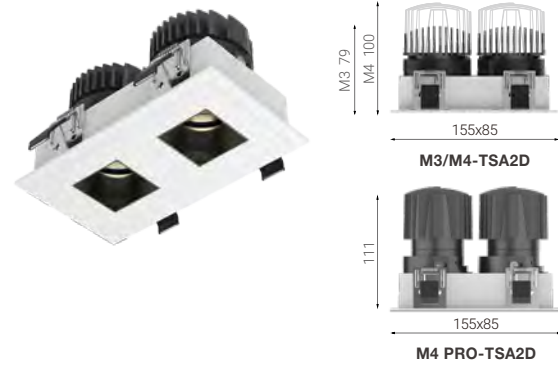

TSA3D

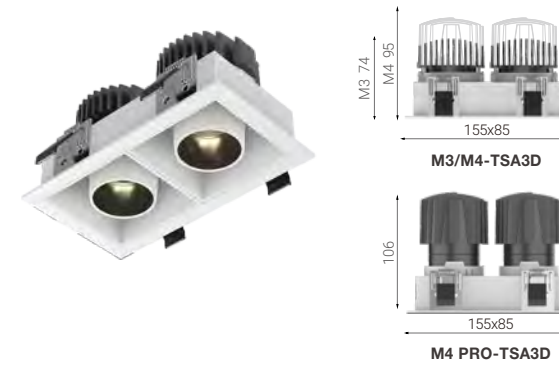

KSA1D-EI

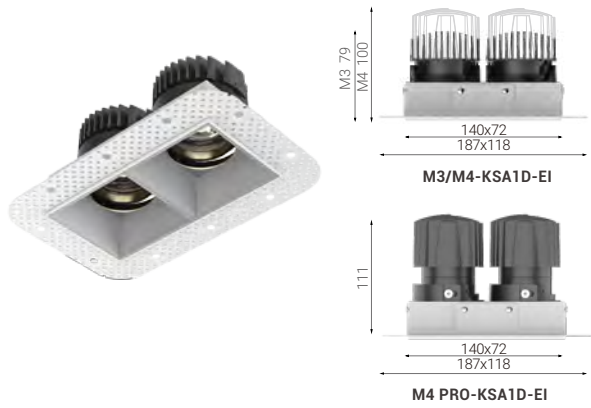

KSA2D-EI

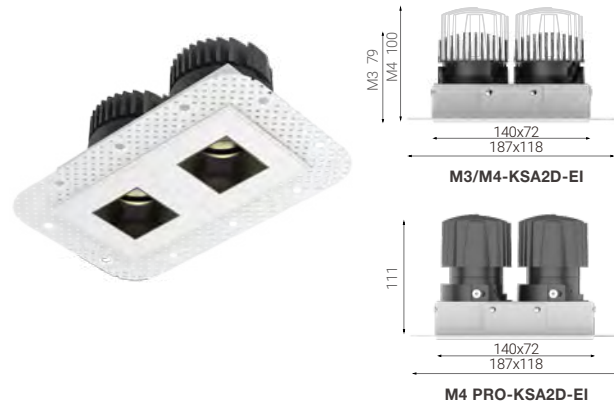

KSA2D-EI

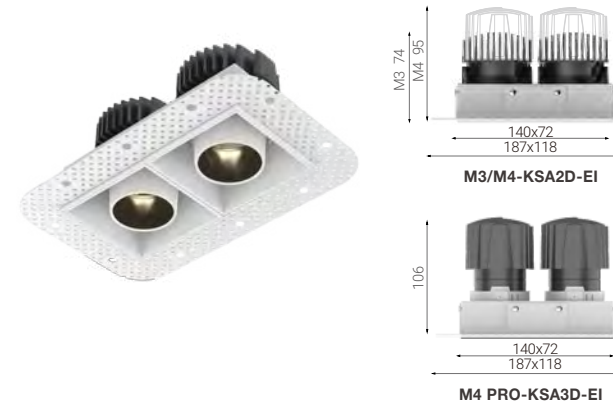

KSA1D

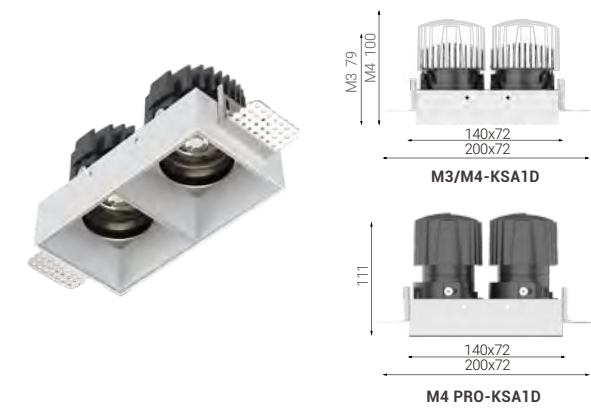
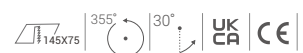

KSA2D

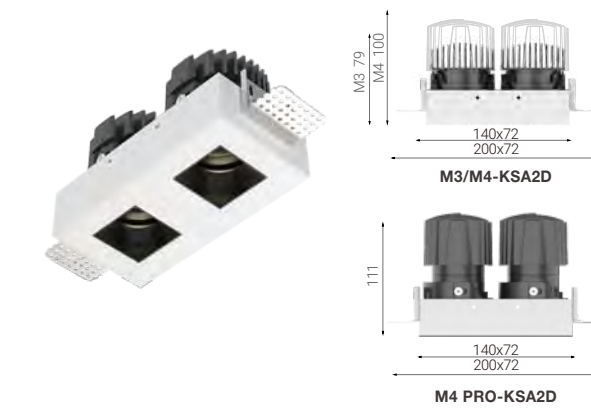

KSA3D

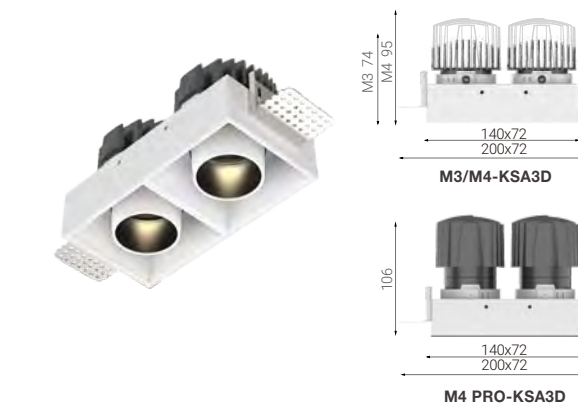

SKYJACK

Incl. Phase Dim Driver
And Fast Connection Box



SKYJACK A68 – Classic Tilttable Downlight



Quick Info

- Ceiling Cut-out: Ø68mm
- Bridgelux LED: 9W, CRI>90
- CCT: 2700K, 3000K Available as Standard
- Beam Angle: 38°
- Lumen Output: Up to 750lm System Luminous Flux
- IP Class: IP44 from Front
- LED Driver: Phase Dim

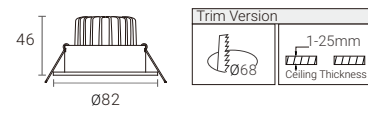

Light Distribution

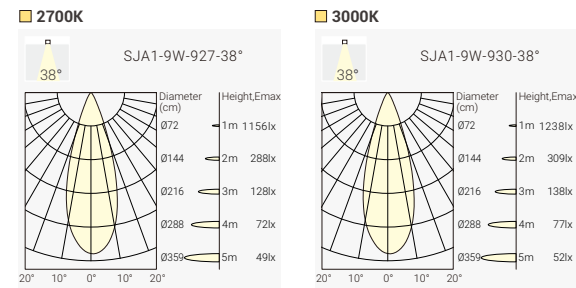

Trim Finish

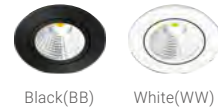

Order Info

LED Power	System Power	LED Voltage	LED Current	CRI	CCT	Beam	LED Output	System Output	Code
9 W	11 W	18 V	500 mA	90	2700K	38°	900lm	720lm	SJA1-9273809P-WW
					3000K	38°	900lm	720lm	SJA1-9273809P-BB
							950lm	750lm	SJA1-9303809P-WW
							950lm	750lm	SJA1-9303809P-BB

Code Remark: P=P(Phase Dim)

SKYJACK A68 – Classic Tilttable Downlight

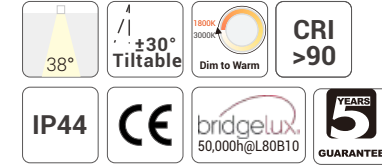

Quick Info

- Ceiling Cut-out: Ø68mm
- Bridgelux LED: 6W, CRI>90
- CCT: Dim to Warm 1800K-3000K
- Beam Angle: 38°
- Lumen Output: Up to Max.450lm System Luminous Flux
- IP Class: IP44 from Front
- LED Driver: Phase Dim

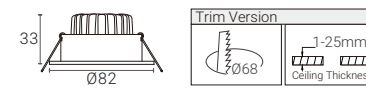

Light Distribution

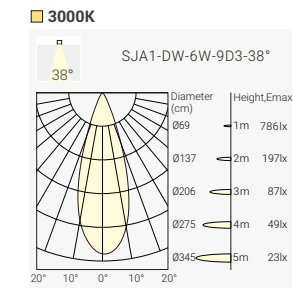

Trim Finish

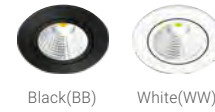

Order Info

LED Power	System Power	LED Voltage	LED Current	CRI	CCT	Beam	LED Output	System Output	Code
6 W	8 W	18 V	350 mA	90	1800K-3000k	38°	650lm	Max.450lm	SJA1-9D33806P-WW
							650lm	Max.450lm	SJA1-9D33806P-BB

Code Remark: P=P(Phase Dim)



SKYJACK D – Recessed Architectural Tiltable Downlight

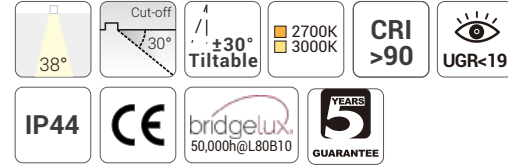

Quick Info

- Ceiling Cut-out: Ø70mm
- Bridgelux LED: 9W, CRI>90
- CCT: 2700K, 3000K Available as Standard
- Beam Angle: 38°
- Lumen Output: Up to 750lm System Luminous Flux
- IP Class: IP44 from Front
- LED Driver: Phase Dim

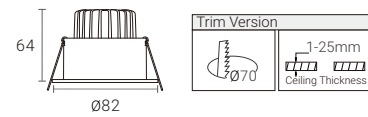

Light Distribution

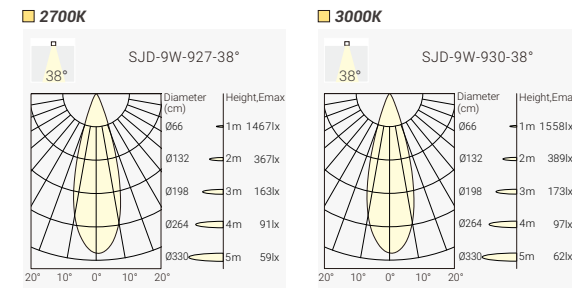

Trim Finsh

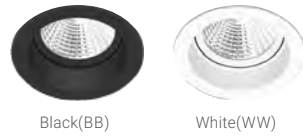

Order Info

LED Power	System Power	LED Voltage	LED Current	CRI	CCT	Beam	LED Output	System Output	Code
9 W	11 W	18 V	500 mA	90	2700K	38°	900lm	700lm	SJD-9273809P-WW
							900lm	650lm	SJD-9273809P-BB
					3000K	38°	950lm	750lm	SJD-9303809P-WW
							950lm	700lm	SJD-9303809P-BB

Code Remark: P=P(Phase Dim)

SKYJACK D-DW – Recessed Architectural Tiltable Downlight

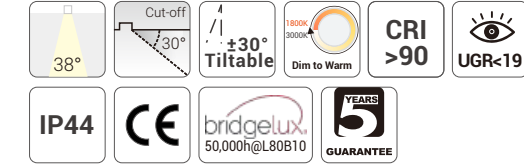

Quick Info

- Ceiling Cut-out: Ø70mm
- Bridgelux LED: 6W, CRI>90, Bridgelux
- CCT: Dim to Warm 1800K-3000K
- Beam Angle: 38°
- Lumen Output: Up to Max.450lm System Luminous Flux
- IP Class: IP44 from Front
- LED Driver: Phase Dim

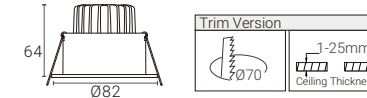

Light Distribution

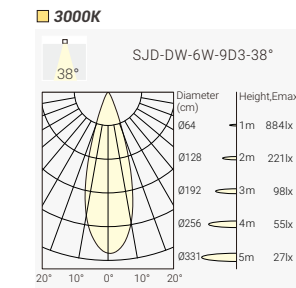

Trim Finsh



Order Info

LED Power	System Power	LED Voltage	LED Current	CRI	CCT	Beam	LED Output	System Output	Code
6 W	8 W	18 V	350 mA	90	1800K-3000k	38°	650lm	Max.450lm	SJA1-9D33806P-WW
							650lm	Max.400lm	SJA1-9D33806P-BB

Code Remark: P=P(Phase Dim)

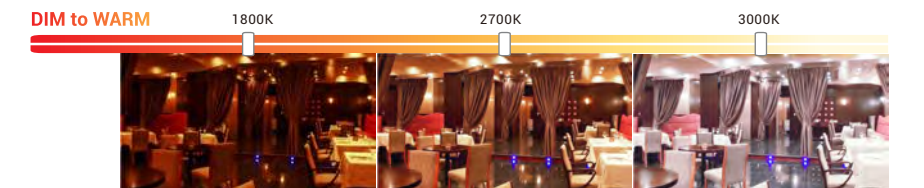

SKYJACK F – IP65 Fixed Downlight



Quick Info

- Ceiling Cut-out: Ø68mm
- Bridgelux LED: 9W, CRI>90
- CCT: 2700K, 3000K Available as Standard
- Beam Angle: 38°
- Lumen Output: Up to 750lm System Luminous Flux
- IP Class: IP65 from Front
- LED Driver: Phase Dim

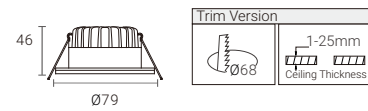

Light Distribution

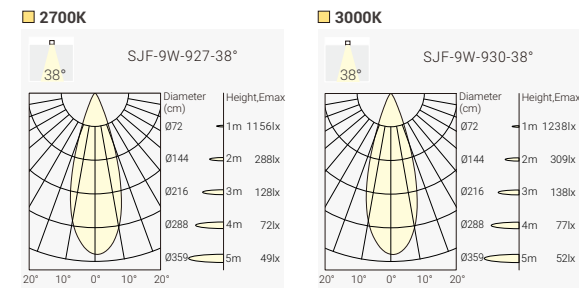

Trim Finish

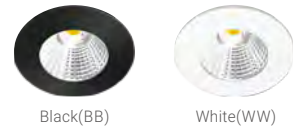

Order Info

LED Power	System Power	LED Voltage	LED Current	CRI	CCT	Beam	LED Output	System Output	Code
9 W	11 W	18 V	500 mA	90	2700K	38°	900lm	720lm	SJF-9273809P-WW
					3000K	38°	900lm	720lm	SJF-9273809P-BB
							950lm	750lm	SJF-9303809P-WW
							950lm	750lm	SJF-9303809P-BB

Code Remark: P=P(Phase Dim)



SKYJACK 145 – Shop & Corridors Tiltable Downlight

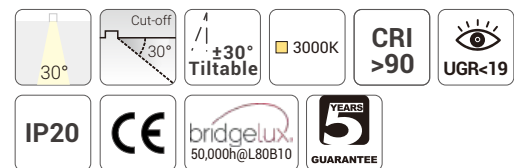

Quick Info

- Ceiling Cut-out: Ø145mm
- Bridgelux LED: 25W, CRI>90, Bridgelux
- CCT: 3000K Available as Standard
- Beam Angle: 30°
- Lumen Output: Up to 2200lm System Luminous Flux
- IP Class: IP20
- LED Driver: On-Off, Phase Dim, 1-10V Dim, DALI Dim

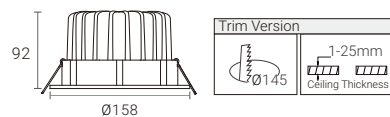

Light Distribution

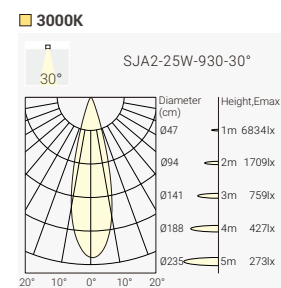

Trim Finish



Order Info

LED Power	System Power	LED Voltage	LED Current	CRI	CCT	Beam	LED Output	System Output	Code
25 W	28 W	36 V	700 mA	90	3000K	30°	2500lm	2200lm	SJA2-9303025N-WW SJA2-9303025N-BB

Code Remark: N=N(No Driver) F=F(ON-OFF) P=P(Phase Dim) A=A(1-10V Dim) D=D(DALI Dim)



KENZO

Recessed Adjustable Spotlight
Powerful Light & Energy Efficient
Suitable for Any Architectural Ambience

Project: NETO, Israel





Project: Likuid Spaces, Sri Lanka



Project: Pinto design and architectural agency, France



KENZO K1X30 – Recessed Adjustable Spotlight

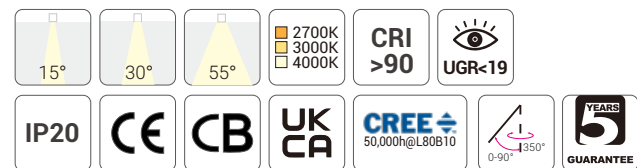

Quick Info

- Ceiling Cut-out: Ø46mm for Trim Version
- CREE LED: 4W, CRI>90
- CCT: 2700K, 3000K, 4000K Available as Standard
- Beam Angle: 15°, 40°, 50°
- Lumen Output: Up to 350lm System Luminous Flux
- IP Class: IP20
- LED Driver: On-Off, Phase Dim, 1-10V Dim, DALI Dim

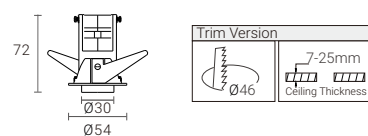

Light Distribution

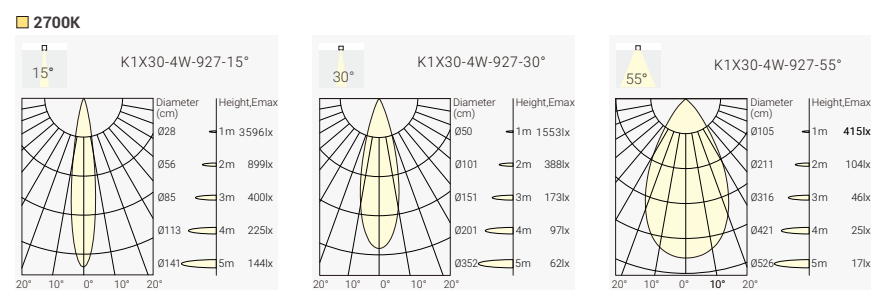

Housing Finish



Order Info (KENZO K1X30 in White Housing & Black Reflector as an Example)

LED Power	System Power	LED Voltage	LED Current	CRI	CCT	Beam	LED Output	System Output	Code	
4W	6W	12V	350mA	90	2700K	15°	350lm	300lm	K1S-9271504N-WB	
						30°	350lm	300lm	K1S-9273004N-WB	
						55°	350lm	300lm	K1S-9275504N-WB	
						3000K	15°	400lm	320lm	K1S-9301504N-WB
							30°	400lm	320lm	K1S-9303004N-WB
							55°	400lm	320lm	K1S-9305504N-WB
						4000K	15°	450lm	350lm	K1S-9401504N-WB
							30°	450lm	350lm	K1S-9403004N-WB
							55°	450lm	350lm	K1S-9405504N-WB

Code Remark: N=N(No Driver) F=F(ON-OFF) P=P(Phase Dim) A=A(1-10V Dim) D=D(DALI Dim)

Reflector Options

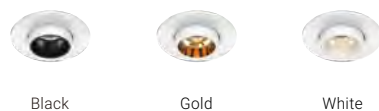

Coding

Model	CRI/ CCT	Beam Angle	LED Power	Control	Trim Finish	Reflector Color	Accessory
K1S KENZO K1X30	927 CRI>90/ 2700K	15°	04 4W	N No Driver	W White	B Black	H Honeycomb
	930 CRI>90/ 3000K	30°		F On-Off	B Black	W White	
	940 CRI>90/ 4000K	55°		P Phase Dim		G Gold	
				A 1-10V Dim			
				D DALI Dim			

Optional accessory

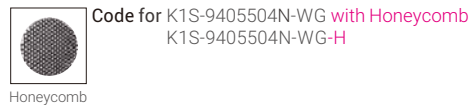

KENZO K1X55 – Recessed Adjustable Spotlight

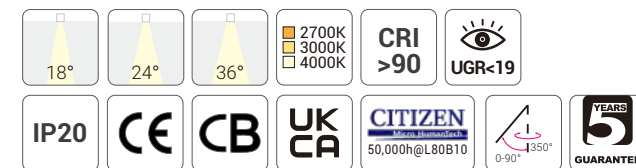

Quick Info

- Ceiling Cut-out: Ø80mm for Trim Version
- CITIZEN LED: 9W, CRI>90
- CCT: 2700K, 3000K, 4000K Available as Standard
- Beam Angle: 18°, 24°, 36°
- Lumen Output: Up to 800lm System Luminous Flux
- IP Class: IP20
- LED Driver: On-Off, Phase Dim, 1-10V Dim, DALI Dim, Casambi Wireless Dim

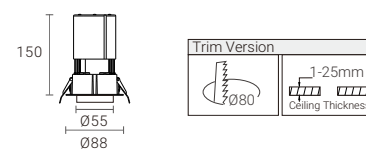

Light Distribution

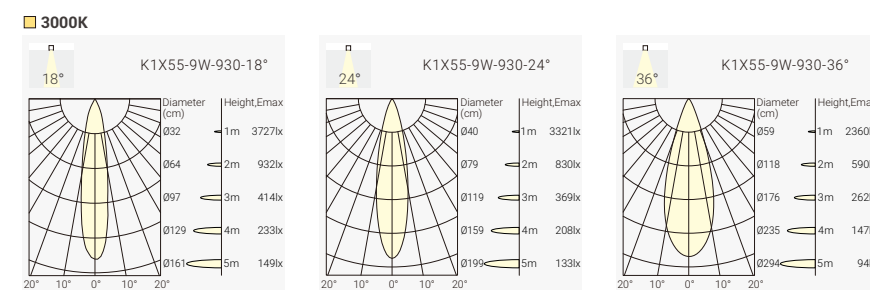

Housing Finish

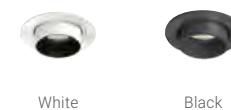

Order Info (KENZO K1X55 in White Housing & Black Reflector as an Example)

LED Power	System Power	LED Voltage	LED Current	CRI	CCT	Beam	LED Output	System Output	Code	
9W	11W	36V	250mA	90	2700K	18°	850lm	700lm	K1M-9271809N-WB	
						24°	850lm	700lm	K1M-9272409N-WB	
						36°	850lm	700lm	K1M-9273609N-WB	
						3000K	18°	950lm	720lm	K1M-9301809N-WB
							24°	950lm	720lm	K1M-9302409N-WB
							36°	950lm	720lm	K1M-9303609N-WB
						4000K	18°	1050lm	800lm	K1M-9401809N-WB
							24°	1050lm	800lm	K1M-9402409N-WB
							36°	1050lm	800lm	K1M-9403609N-WB

Code Remark: N=N(No Driver) F=F(ON-OFF) P=P(Phase Dim) A=A(1-10V Dim) D=D(DALI Dim)

Reflector Options

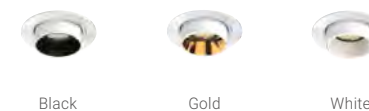

Coding

Model	CRI/ CCT	Beam Angle	LED Power	Control	Trim Finish	Reflector Color	Accessory
K1M KENZO K1X55	927 CRI>90/ 2700K	18°	09 9W	N No Driver	W White	B Black	H Honeycomb
	930 CRI>90/ 3000K	24°		F On-Off	B Black	W White	
	940 CRI>90/ 4000K	36°		P Phase Dim		G Gold	
				A 1-10V Dim			
				D DALI Dim			

Optional accessory

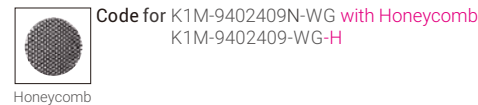

KENZO K1X70 – Recessed Adjustable Spotlight



Quick Info

- Ceiling Cut-out: Ø100mm for Trim Version
- CITIZEN LED: 13W, 18W, CRI>90
- CCT: 2700K, 3000K, 4000K Available as Standard
- Beam Angle: 15°, 25°, 30°
- Lumen Output: Up to 1700lm System Luminous Flux
- IP Class: IP20
- LED Driver: On-Off, Phase Dim, 1-10V Dim, DALI Dim, Casambi Wireless Dim

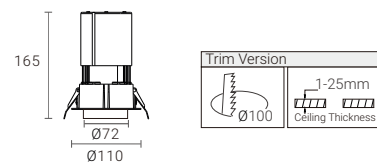

Light Distribution

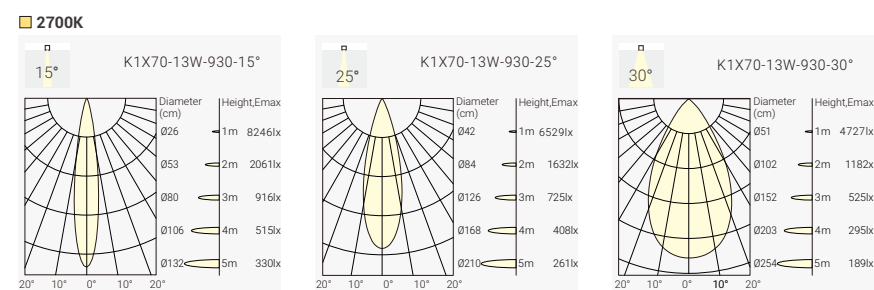

Housing Finish



Order Info (KENZO K1X70 in White Housing & Black Reflector as an Example)

LED Power	System Power	LED Voltage	LED Current	CRI	CCT	Beam	LED Output	System Output	Code						
13W	15W	36V	350mA	90	2700K	15°	1400lm	1100lm	K1L1-9271513N-WB						
						25°	1400lm	1100lm	K1L1-9272513N-WB						
						30°	1400lm	1100lm	K1L1-9273013N-WB						
						3000K	15°	1500lm	1200lm	K1L1-9301513N-WB					
							25°	1500lm	1200lm	K1L1-9302513N-WB					
							30°	1500lm	1200lm	K1L1-9303013N-WB					
						4000K	15°	1600lm	1300lm	K1L1-9401513N-WB					
							25°	1600lm	1300lm	K1L1-9402513N-WB					
							30°	1600lm	1300lm	K1L1-9403013N-WB					
						18W	21W	36V	500mA	90	2700K	15°	1800lm	1500lm	K1L2-9271518N-WB
												25°	1800lm	1500lm	K1L2-9272518N-WB
												30°	1800lm	1500lm	K1L2-9273018N-WB
3000K	15°	2000lm	1600lm	K1L2-9301518N-WB											
	25°	2000lm	1600lm	K1L2-9302518N-WB											
	30°	2000lm	1600lm	K1L2-9303018N-WB											
4000K	15°	2200lm	1700lm	K1L2-9401518N-WB											
	25°	2200lm	1700lm	K1L2-9402518N-WB											
	30°	2200lm	1700lm	K1L2-9403018N-WB											

Code Remark: N=N(No Driver) F=F(ON-OFF) P=P(Phase Dim) A=A(1-10V Dim) D=D(DALI Dim)

Reflector Options



Coding

K1L1 - *** ** * - * * - *

Model	CRI/ CCT	Beam Angle	LED Power	Control	Trim Finish	Reflector Color	Accessory
K1L1 K1X70-13W	927 CRI>90/ 2700K	15 15°	13 13W	N No Driver	W White	B Black	H Honeycomb
K1L2 K1X70-18W	930 CRI>90/ 3000K	25 25°	18 18W	F On-Off	B Black	W White	
	940 CRI>90/ 4000K	30 30°		P Phase Dim		G Gold	
				A 1-10V Dim			
				D DALI Dim			

Optional accessory

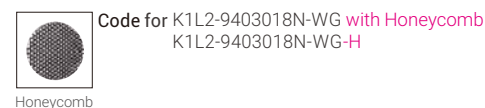

FUSION

The Narrow Linear Downlight Series
Featuring Fixed Downlights,
Adjustable Downlights,
Spotlights,
Wall Washer Downlights,
General Light Downlights.

Project: Eggen Restaurant, Norway



FUSION – The Narrow Linear Downlight Series

Create a circle of light from a line of LED Downlights

A narrow line of nano LED Downlights for pure minimalism

Superior glare control for high performance and visual comfort

Fixed, Adjustable, Wall Washer, General Light, Spotlight and Trimless versions for choice

Aluminum housing and in powder-coated finish, excellent dissipation performance & antirust

LED chip in standard CRI>90 and 3-step MacAdam for perfect color consistency

Color temperature in 2700K, 3000K and 4000K for selection

Different functions LED driver in On-Off, Phase Dim, 1-10V Dim and DALI Dim

Trimless Version



Trim Version



Fixed

Adjustable

Wall Washer

General Light

Spotlight

Trimless Spotlight

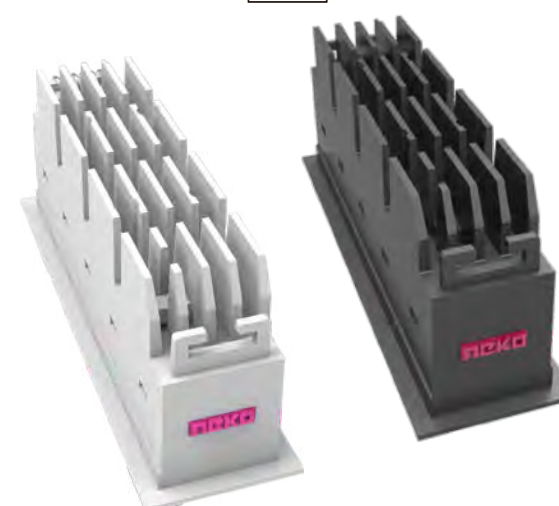
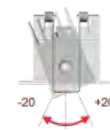
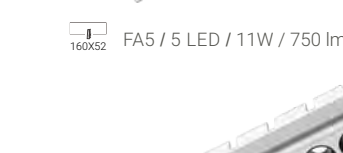
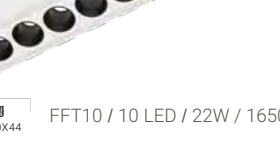
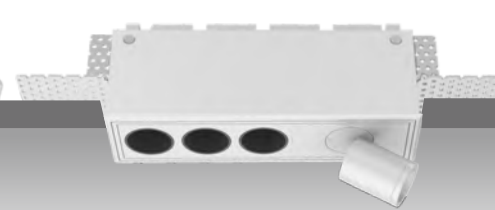

Secondary Reflector

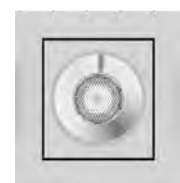
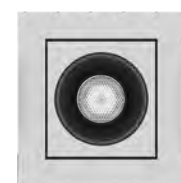

Black

Specular

Beam

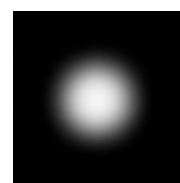

Medium 24°

Wide 40°



Black Reflector



1 LED / 2W / 160lm



2 LED / 4W / 330lm



3 LED / 7W / 500lm



5 LED / 11W / 750lm



10 LED / 22W / 1650lm

Specular Reflector



1 LED / 2W / 180lm



2 LED / 4W / 360lm



3 LED / 7W / 540lm



5 LED / 11W / 850lm



10 LED / 22W / 1850lm

Secondary Reflector

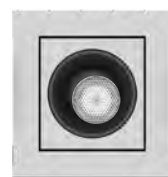

Black

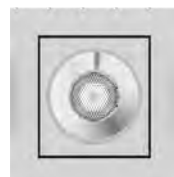

Specular

Beam

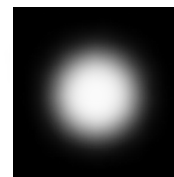

Medium 24°

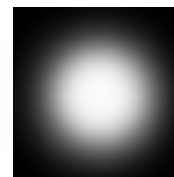

Wide 40°

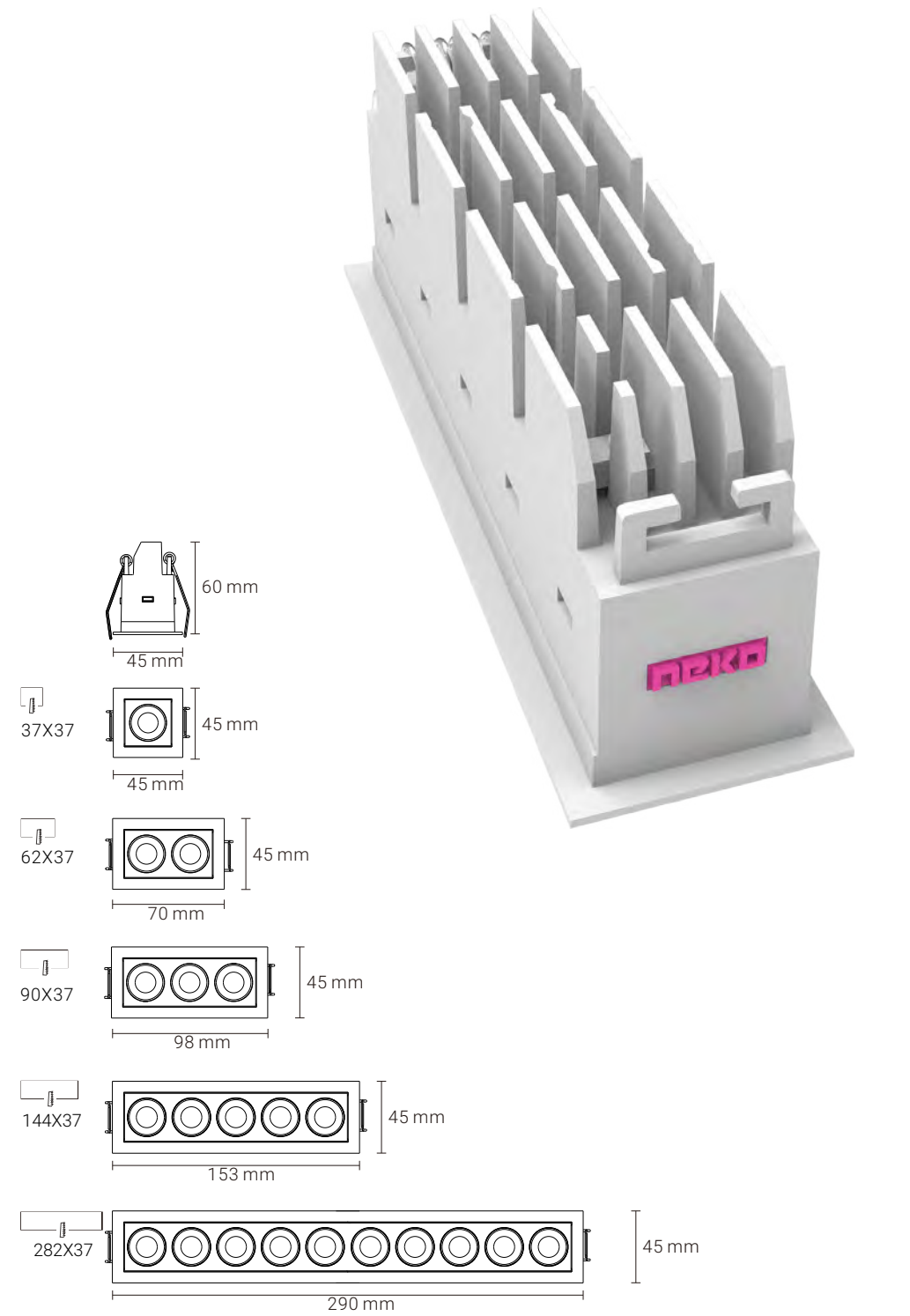



Project: BVLGARI Hotel, Shanghai, China

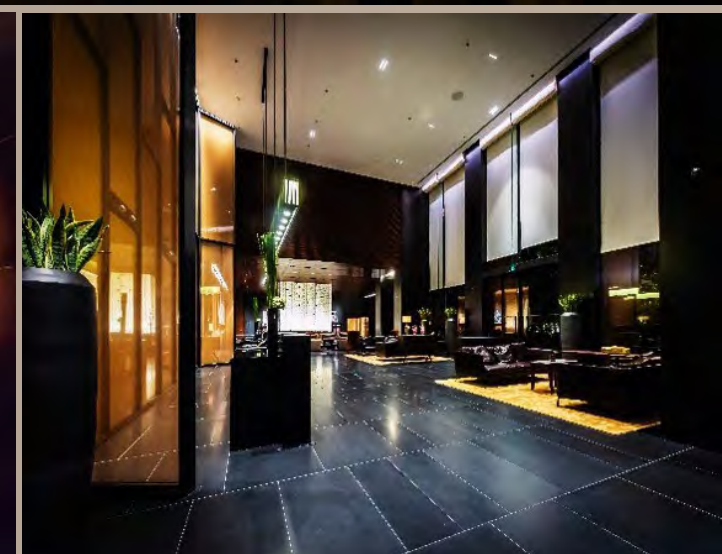

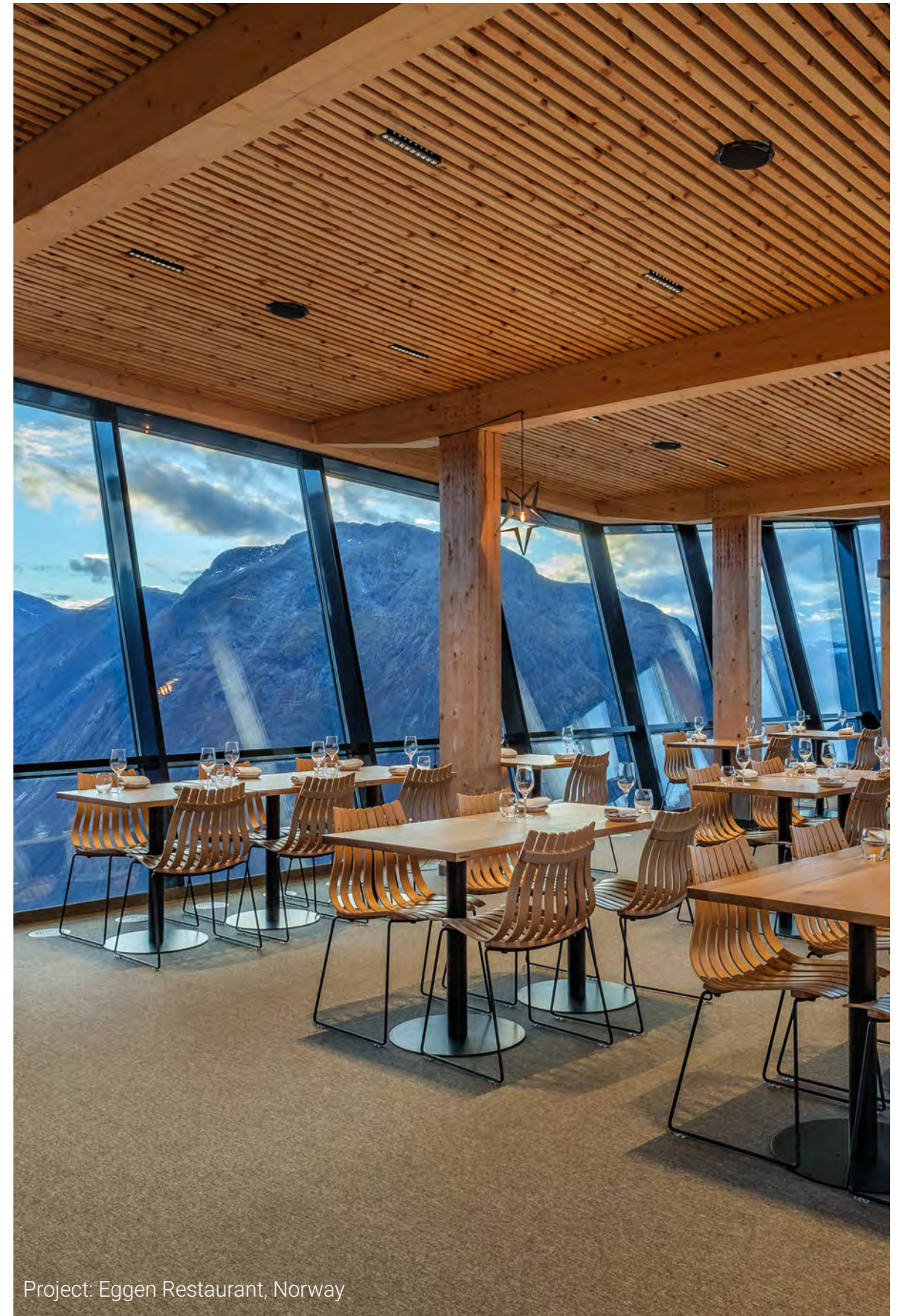

Project: Eggen Restaurant, Norway

FUSION – The Narrow Linear Downlight Series

Project: Oslo Hall, City Hall Gallery, Norway



FUSION FF1 – Fixed LED Downlight



Quick Info

- Ceiling Cut-out: 37x37mm
- OSRAM LED: 2W, CRI>90
- CCT: 2700K, 3000K, 4000K Available as Standard
- Beam Angle: 24°, 40°
- Lumen Output: Up to 160lm System Luminous Flux
- IP Class: IP20
- LED Driver: On-Off, Phase Dim, 1-10V Dim, DALI Dim

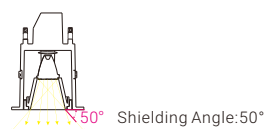
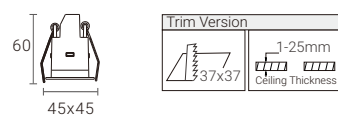

Light Distribution

3000K

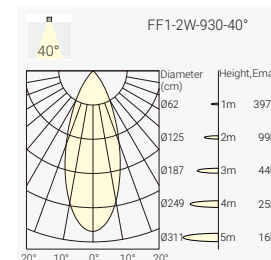
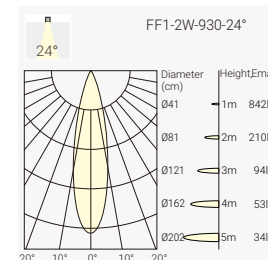

Finish



White



Black

Order Info (FUSION FF1 in White Trim & Black Reflector as an Example)

LED Power	System Power	LED Voltage	LED Current	CRI	CCT	Beam	LED Output	System Output	Code
2W	3W	3V	700mA	90	2700K	24°	200lm	130lm	FF1-9272402N-WB
						40°	200lm	130lm	FF1-9274002N-WB
					3000K	24°	210lm	140lm	FF1-9302402N-WB
						40°	210lm	140lm	FF1-9304002N-WB
					4000K	24°	230lm	155lm	FF1-9402402N-WB
						40°	230lm	155lm	FF1-9404002N-WB

Code Remark: N=N(No Driver) F=F(ON-OFF) P=P(Phase Dim) A=A(1-10V Dim) D=D(DALI Dim)

Coding

Model	CRI/ CCT	Beam Angle	LED Power	Control	Finish	Reflector Color	Accessory
FF1	927	24	02	N	W	B	
FUSION FF1	CRI>90/ 2700K	24°	2W	No Driver	White	Black	
	930	40		F	B		
	CRI>90/ 3000K	40°		On-Off	Black		
	940			P			
	CRI>90/ 4000K			Phase Dim			
				A			
				1-10V Dim			
				D			
				DALI Dim			

Project: Muyang Museum, China



FUSION FF2 – Fixed LED Spotlight



Quick Info

- Ceiling Cut-out: 68x37mm
- OSRAM LED: 4W, CRI>90
- CCT: 2700K, 3000K, 4000K Available as Standard
- Beam Angle: 24°, 40°
- Lumen Output: Up to 330lm System Luminous Flux
- IP Class: IP20
- LED Driver: On-Off, Phase Dim, 1-10V Dim, DALI Dim

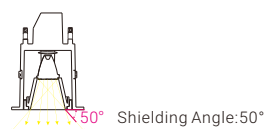
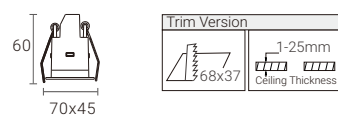

Light Distribution

3000K

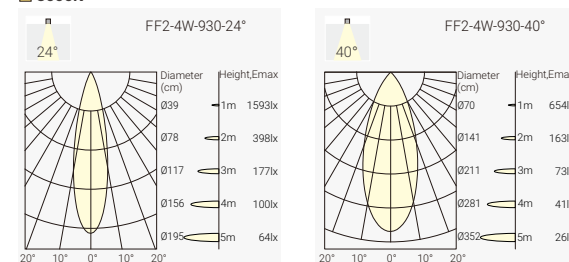

Finish



White

Black

Order Info (FUSION FF2 in White Trim & Black Reflector as an Example)

LED Power	System Power	LED Voltage	LED Current	CRI	CCT	Beam	LED Output	System Output	Code
4W	6W	6 V	700mA	90	2700K	24°	400lm	290lm	FF2-9272404N-WB
						40°	400lm	290lm	FF2-9274004N-WB
					3000K	24°	450lm	300lm	FF2-9302404N-WB
						40°	450lm	300lm	FF2-9304004N-WB
					4000K	24°	500lm	330lm	FF2-9402404N-WB
						40°	500lm	330lm	FF2-9404004N-WB

Code Remark: N=N(No Driver) F=F(ON-OFF) P=P(Phase Dim) A=A(1-10V Dim) D=D(DALI Dim)

Coding

Model	CRI/ CCT	Beam Angle	LED Power	Control	Finish	Reflector Color	Accessory
FF2	927	24	04	N	W	B	
FUSION FF2	CRI>90/ 2700K	24°	4W	No Driver	White	Black	
	930	40		F	B		
	CRI>90/ 3000K	40°		On-Off	Black		
	940			P			
	CRI>90/ 4000K			Phase Dim			
				A			
				1-10V Dim			
				D			
				DALI Dim			

Project: Bvlgari Hotel, Shanghai, China



FUSION FF3 – Fixed LED Spotlight



Quick Info

- Ceiling Cut-out: 90x37mm
- OSRAM LED: 7W, CRI>90
- CCT: 2700K, 3000K, 4000K Available as Standard
- Beam Angle: 24°, 40°
- Lumen Output: Up to 500lm System Luminous Flux
- IP Class: IP20
- LED Driver: On-Off, Phase Dim, 1-10V Dim, DALI Dim

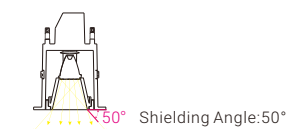
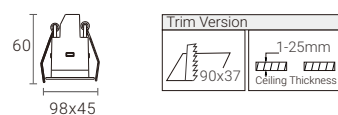

Light Distribution

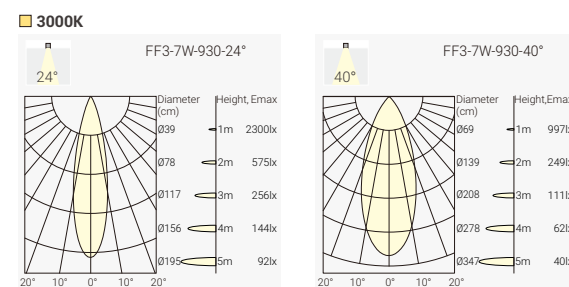

Finish



Order Info (FUSION FF3 in White Trim & Black Reflector as an Example)

LED Power	System Power	LED Voltage	LED Current	CRI	CCT	Beam	LED Output	System Output	Code
7W	9 W	9V	700mA	90	2700K	24°	600lm	420lm	FF3-9272407N-WB
						40°	600lm	420lm	FF3-9274007N-WB
					3000K	24°	650lm	450lm	FF3-9302407N-WB
						40°	650lm	450lm	FF3-9304007N-WB
					4000K	24°	700lm	500lm	FF3-9402407N-WB
						40°	700lm	500lm	FF3-9404007N-WB

Code Remark: N=N(No Driver) F=F(ON-OFF) P=P(Phase Dim) A=A(1-10V Dim) D=D(DALI Dim)

Reflector Options



Coding

Model	CRI/ CCT	Beam Angle	LED Power	Control	Finish	Reflector Color	Accessory
FF3	927	24	07	N	W	B	
FUSION FF3	CRI>90/ 2700K	24°	7W	No Driver	White	Black	
	930	40		F	B	S	
	CRI>90/ 3000K	40°		On-Off	Black	Specular	
	940			P			
	CRI>90/ 4000K			Phase Dim			
				A			
				1-10V Dim			
				D			
				DALI Dim			



Project: Hallunda Station, Sweden

FUSION FF4 – Fixed LED Spotlight



Quick Info

- Ceiling Cut-out: 65x65mm
- OSRAM LED: 9W, CRI>80, CRI>90
- CCT: 2700K, 3000K, 4000K Available as Standard
- Beam Angle: 24°, 40°
- Lumen Output: Up to 650lm System Luminous Flux
- IP Class: IP20
- LED Driver: On-Off, Phase Dim, 1-10V Dim, DALI Dim, Casambi Wireless Dim

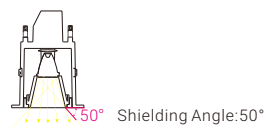
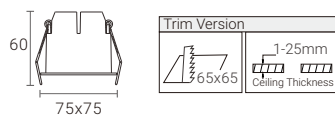

Light Distribution

3000K

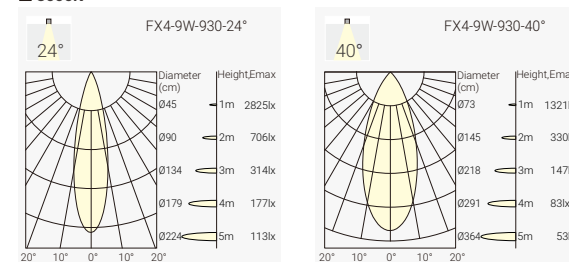

Finish



White Black

Order Info (FUSION FX4 in White Trim & Black Reflector as an Example)

LED Power	System Power	LED Voltage	LED Current	CRI	CCT	Beam	LED Output	System Output	Code
9W	11W	12V	700mA	90	2700K	24°	750lm	550lm	FX4-9272409N-WB
					3000K	24°	750lm	550lm	FX4-9274009N-WB
					4000K	24°	800lm	600lm	FX4-9302409N-WB
						40°	800lm	600lm	FX4-9304009N-WB
						24°	900lm	650lm	FX4-9402409N-WB
						40°	900lm	650lm	FX4-9404009N-WB

Code Remark: N=N(No Driver) F=F(ON-OFF) P=P(Phase Dim) A=A(1-10V Dim) D=D(DALI Dim)

Reflector Options



Black Specular

Coding

Model	CRI/ CCT	Beam Angle	LED Power	Control	Finish	Reflector Color	Accessory
FX4	927	24	09	N	W	B	
FUSION FX4	CRI>90/ 2700K	24°	9W	No Driver	White	Black	
	930	40		F	B	S	
	CRI>90/ 3000K	40°		On-Off	Black	Specular	
	940			P			
	CRI>90/ 4000K			Phase Dim			
				A			
				1-10V Dim			
				D			
				DALI Dim			

Project: Office Helsinki, Finland

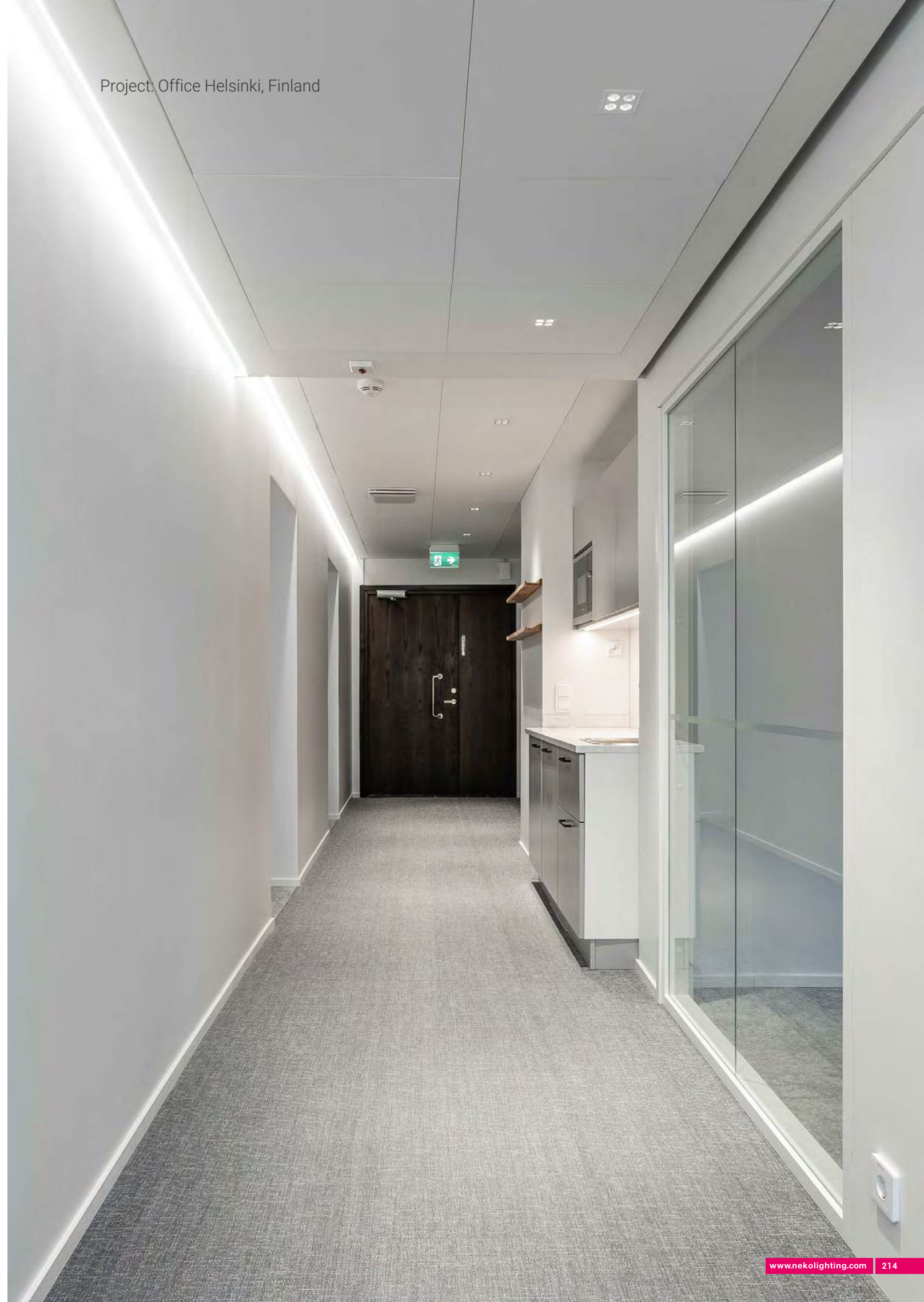

FUSION FF5 – Fixed LED Spotlight

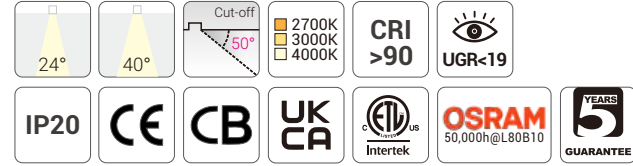

Quick Info

- Ceiling Cut-out: 144x37mm for Trim Version
- OSRAM LED: 11W, CRI>80, CRI>90
- CCT: 2700K, 3000K, 4000K Available as Standard
- Beam Angle: 24°, 40°
- Lumen Output: Up to 750lm System Luminous Flux
- IP Class: IP20
- LED Driver: On-Off, Phase Dim, 1-10V Dim, DALI Dim, Casambi Wireless Dim

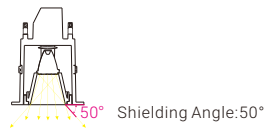
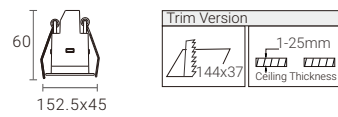

Light Distribution

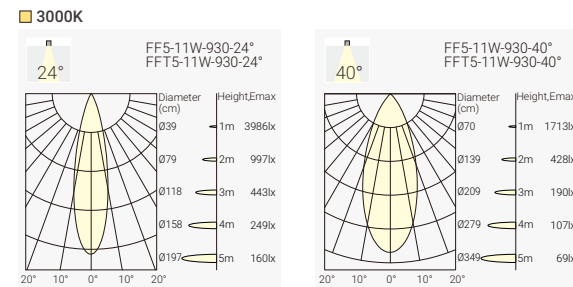

Finish



Order Info (FUSION FF5 in White Trim & Black Reflector as an Example)

LED Power	System Power	LED Voltage	LED Current	CRI	CCT	Beam	LED Output	System Output	Code
11W	13W	15V	700mA	90	2700K	24°	950lm	650lm	FF5-9272411N-WB
					3000K	24°	1050lm	700lm	FF5-9302411N-WB
					4000K	24°	1150lm	750lm	FF5-9402411N-WB
						40°	950lm	650lm	FF5-9274011N-WB
						40°	1050lm	700lm	FF5-9304011N-WB
						40°	1150lm	750lm	FF5-9404011N-WB

Code Remark: N=N(No Driver) F=F(ON-OFF) P=P(Phase Dim) A=A(1-10V Dim) D=D(DALI Dim)

Reflector Options



Coding

Model	CRI/ CCT	Beam Angle	LED Power	Control	Finish	Reflector Color	Accessory
FF5 FUSION FF5	927 CRI>90/ 2700K	24°	11	N No Driver	W White	B Black	
FFT5 FUSION FFT5	930 CRI>90/ 3000K	40°		F On-Off	B Black	S Specular	
	940 CRI>90/ 4000K			P Phase Dim			
				A 1-10V Dim			
				D DALI Dim			

Trimless Version



FFT5

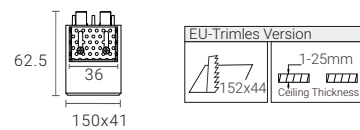

Project: World Health Organization Building, Philippines



FUSION FF10 – Fixed LED Spotlight

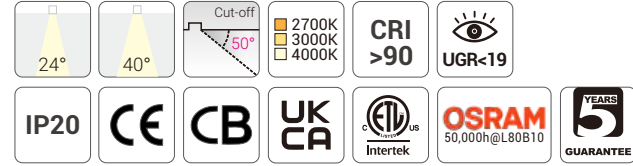

Quick Info

- Ceiling Cut-out: 282x37mm for Trim Version
- OSRAM LED: 22W, CRI>90
- CCT: 2700K, 3000K, 4000K Available as Standard
- Beam Angle: 24°, 40°
- Lumen Output: Up to 1650lm System Luminous Flux
- IP Class: IP20
- LED Driver: On-Off, Phase Dim, 1-10V Dim, DALI Dim, Casambi Wireless Dim

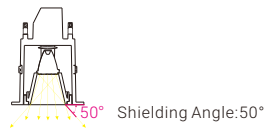
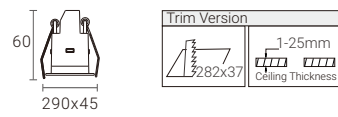

Finish



White



Black

Reflector Options



Specular



Black

Trimless Version



FFT10

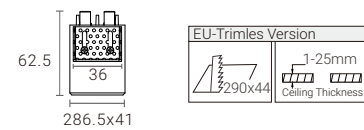

Light Distribution

3000K

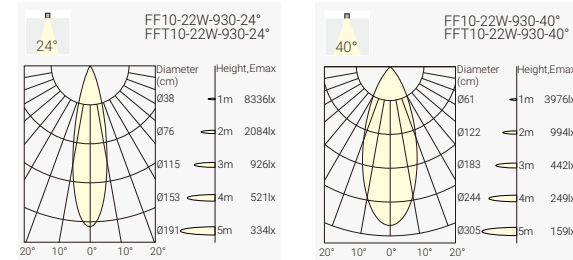

Order Info (FUSION FF10 in White Trim & Black Reflector as an Example)

LED Power	System Power	LED Voltage	LED Current	CRI	CCT	Beam	LED Output	System Output	Code
22 W	24 W	30 V	700 mA	90	2700K	24°	1900lm	1400lm	FF10-9272422N-WB
						40°	1900lm	1400lm	FF10-9274022N-WB
					3000K	24°	2050lm	1500lm	FF10-9302422N-WB
						40°	2050lm	1500lm	FF10-9304022N-WB
					4000K	24°	2200lm	1650lm	FF10-9402422N-WB
						40°	2200lm	1650lm	FF10-9404022N-WB

Code Remark: N=N(No Driver) F=F(ON-OFF) P=P(Phase Dim) A=A(1-10V Dim) D=D(DALI Dim)

Coding

Model	CRI/ CCT	Beam Angle	LED Power	Control	Finish	Reflector Color	Accessory
FF10 FUSION FF10	927 CRI>90/ 2700K	24°	22	N No Driver	W White	B Black	
FFTA FUSION FFT10	930 CRI>90/ 3000K	40°		F On-Off	B Black	S Specular	
	940 CRI>90/ 4000K			P Phase Dim			
				A 1-10V Dim			
				D DALI Dim			

Project: Bvlgari Hotel, Shanghai, China

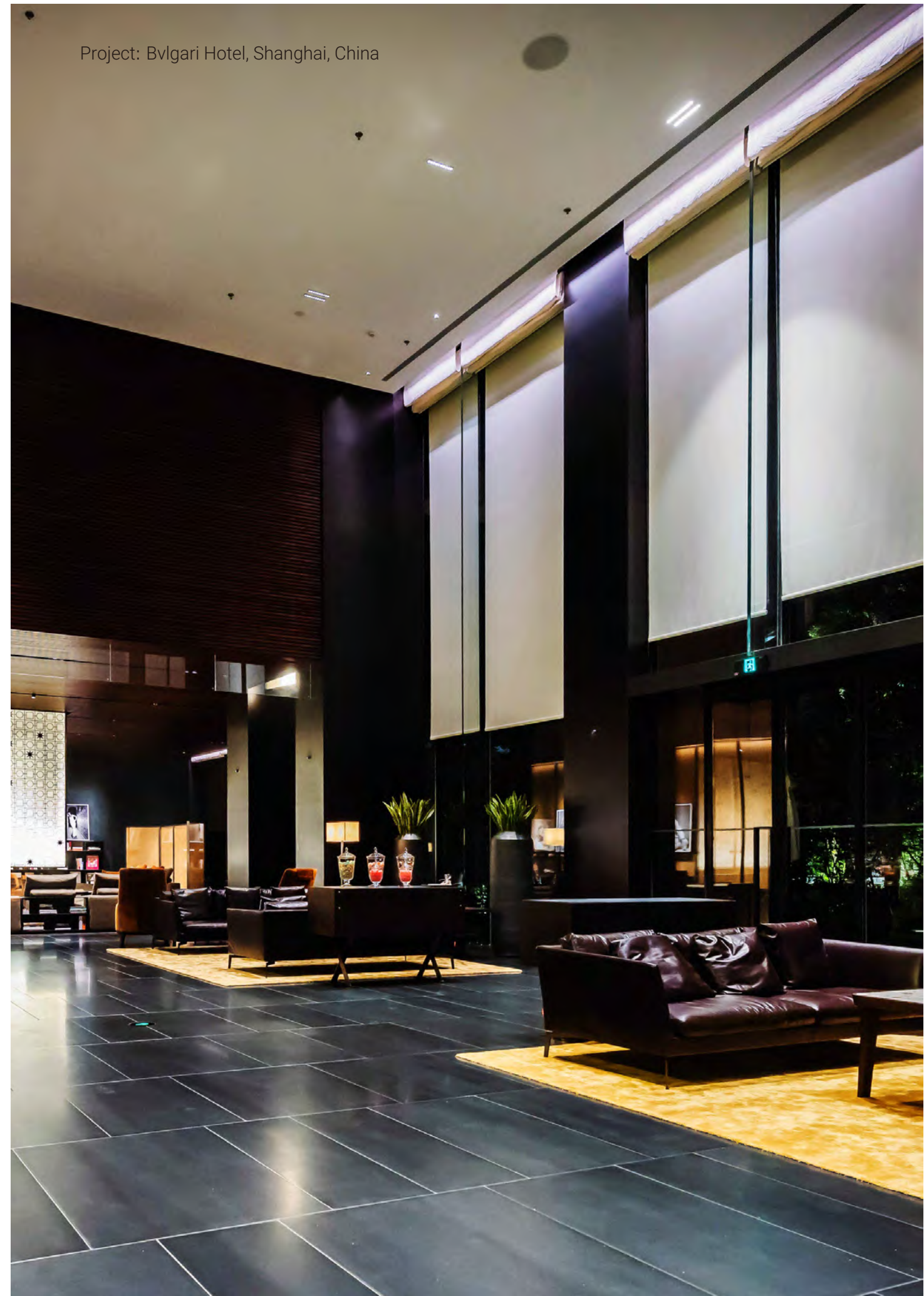

FUSION FF2-IP65 – Surface IP65 FUSION Downlight

NEW



Quick Info

- Ceiling Cut-out: 66x37mm
- OSRAM LED: 4W, CRI>90
- CCT: 2700K, 3000K, 4000K Available as Standard
- Beam Angle: 35°, 45°
- Lumen Output: Up to 270lm System Luminous Flux
- IP Class: IP65 from Front
- LED Driver: On-Off, Phase Dim, 1-10V Dim, DALI Dim

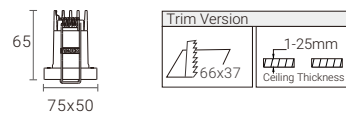

Light Distribution

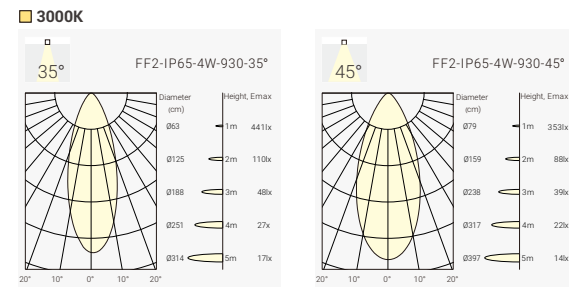

Finish



Order Info (FUSION FF2-IP65 in White Housing & Black Reflector as an Example)

LED Power	System Power	LED Voltage	LED Current	CRI	CCT	Beam	LED Output	System Output	Code
4W	6W	6V	700mA	90	2700K	35°	400lm	240lm	FF2-9273504N-WB-IP
						45°	400lm	205lm	FF2-9274504N-WB-IP
					3000K	35°	450lm	250lm	FF2-9303504N-WB-IP
						45°	450lm	215lm	FF2-9304504N-WB-IP
					4000K	35°	500lm	270lm	FF2-9403504N-WB-IP
						45°	500lm	230lm	FF2-9404504N-WB-IP

Code Remark: N=N(No Driver) F=F(ON-OFF) P=P(Phase Dim) A=A(1-10V Dim) D=D(DALI Dim)

Coding

Model	CRI/ CCT	Beam Angle	LED Power	Control	Finish	Reflector Color	Accessory
FF2	927	35	04	N	W	B	IP
FF2-IP65	CRI>90/ 2700K	35°	4W	No Driver	White	Black	IP65
	930	45		F	B		
	CRI>90/ 3000K	45°		On-Off	Black		
	940			P			
	CRI>90/ 4000K			Phase Dim			
				A			
				1-10V Dim			
				D			
				DALI Dim			

FUSION FF3-IP65 – Surface IP65 FUSION Downlight

NEW



Quick Info

- Ceiling Cut-out: 90x37mm
- OSRAM LED: 7W, CRI>90
- CCT: 2700K, 3000K, 4000K Available as Standard
- Beam Angle: 35°, 45°
- Lumen Output: Up to 410lm System Luminous Flux
- IP Class: IP65 from Front
- LED Driver: On-Off, Phase Dim, 1-10V Dim, DALI Dim

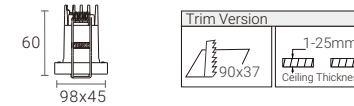

Light Distribution

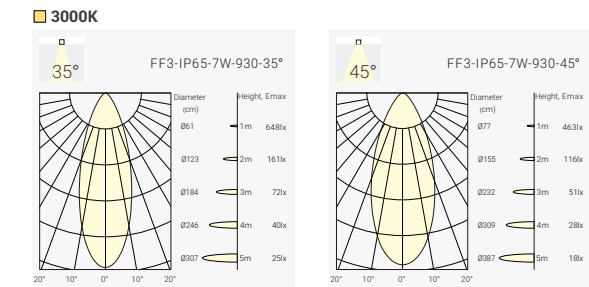

Finish

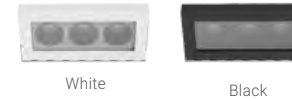

Order Info (FUSION FF3-IP65 in White Housing & Black Reflector as an Example)

LED Power	System Power	LED Voltage	LED Current	CRI	CCT	Beam	LED Output	System Output	Code
7W	9W	9V	700mA	90	2700K	35°	600lm	360lm	FF3-9273507N-WB-IP
						45°	600lm	315lm	FF3-9274507N-WB-IP
					3000K	35°	650lm	385lm	FF3-9303507N-WB-IP
						45°	650lm	335lm	FF3-9304507N-WB-IP
					4000K	35°	700lm	410lm	FF3-9403507N-WB-IP
						45°	700lm	350lm	FF3-9404507N-WB-IP

Code Remark: N=N(No Driver) F=F(ON-OFF) P=P(Phase Dim) A=A(1-10V Dim) D=D(DALI Dim)

Coding

Model	CRI/ CCT	Beam Angle	LED Power	Control	Finish	Reflector Color	Accessory
FF3	927	35	07	N	W	B	IP
FF3-IP65	CRI>90/ 2700K	35°	7W	No Driver	White	Black	IP65
	930	45		F	B		
	CRI>90/ 3000K	45°		On-Off	Black		
	940			P			
	CRI>90/ 4000K			Phase Dim			
				A			
				1-10V Dim			
				D			
				DALI Dim			

FUSION FF5-IP65 – Surface IP65 FUSION Downlight

NEW



Quick Info

- Ceiling Cut-out: 148x37mm
- OSRAM LED: 11W, CRI>90
- CCT: 2700K, 3000K, 4000K Available as Standard
- Beam Angle: 35°, 45°
- Lumen Output: Up to 840lm System Luminous Flux
- IP Class: IP65 from Front
- LED Driver: On-Off, Phase Dim, 1-10V Dim, DALI Dim, Casambi Wireless Dim

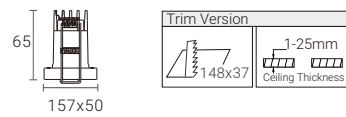

Light Distribution

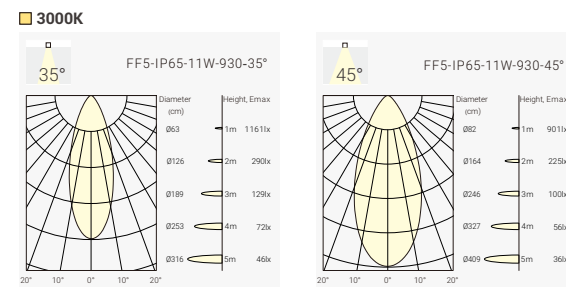

Finish



Order Info (FUSION FF5-IP65 in White Housing & Black Reflector as an Example)

LED Power	System Power	LED Voltage	LED Current	CRI	CCT	Beam	LED Output	System Output	Code
11W	13W	15V	700mA	90	2700K	35°	950lm	745lm	FF5-9273511N-WB-IP
						45°	950lm	620lm	FF5-9274511N-WB-IP
					3000K	35°	1050lm	785lm	FF5-9303511N-WB-IP
						45°	1050lm	650lm	FF5-9304511N-WB-IP
					4000K	35°	1150lm	840lm	FF5-9403511N-WB-IP
						45°	1150lm	700lm	FF5-9404511N-WB-IP

Code Remark: N=N(No Driver) F=F(ON-OFF) P=P(Phase Dim) A=A(1-10V Dim) D=D(DALI Dim)

Coding

Model	CRI/ CCT	Beam Angle	LED Power	Control	Finish	Reflector Color	Accessory
FF5	927	35	11	N	W	B	IP
FF5-IP65	CRI>90/ 2700K	35°	11W	No Driver	White	Black	IP65
	930	45		F	B		
	CRI>90/ 3000K	45°		On-Off	Black		
	940			P			
	CRI>90/ 4000K			Phase Dim			
				A			
				1-10V Dim			
				D			
				DALI Dim			

FUSION FF10-IP65 – Surface IP65 FUSION Downlight

NEW



Quick Info

- Ceiling Cut-out: 286x37mm
- OSRAM LED: 22W, CRI>90
- CCT: 2700K, 3000K, 4000K Available as Standard
- Beam Angle: 35°, 40°
- Lumen Output: Up to 1400lm System Luminous Flux
- IP Class: IP65 from Front
- LED Driver: On-Off, Phase Dim, 1-10V Dim, DALI Dim, Casambi Wireless Dim

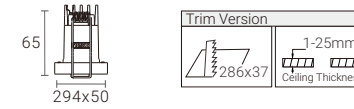

Light Distribution

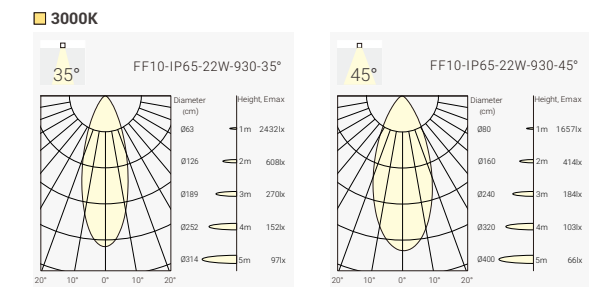

Finish

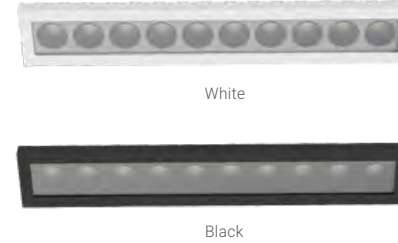

Order Info (FUSION FF10-IP65 in White Housing & Black Reflector as an Example)

LED Power	System Power	LED Voltage	LED Current	CRI	CCT	Beam	LED Output	System Output	Code
22W	24W	30V	700mA	90	2700K	35°	1900lm	1250lm	FF10-9272422N-WB-IP
						45°	1900lm	1200lm	FF10-9274022N-WB-IP
					3000K	35°	2050lm	1300lm	FF10-9302422N-WB-IP
						45°	2050lm	1250lm	FF10-9304022N-WB-IP
					4000K	35°	2200lm	1400lm	FF10-9402422N-WB-IP
						45°	2200lm	1300lm	FF10-9404022N-WB-IP

Code Remark: N=N(No Driver) F=F(ON-OFF) P=P(Phase Dim) A=A(1-10V Dim) D=D(DALI Dim)

Coding

Model	CRI/ CCT	Beam Angle	LED Power	Control	Finish	Reflector Color	Accessory
FF10	927	35	22	N	W	B	IP
FF10-IP65	CRI>90/ 2700K	35°	22W	No Driver	White	Black	IP65
	930	45		F	B		
	CRI>90/ 3000K	45°		On-Off	Black		
	940			P			
	CRI>90/ 4000K			Phase Dim			
				A			
				1-10V Dim			
				D			
				DALI Dim			

FUSION FA5 – Adjustable LED Downlight

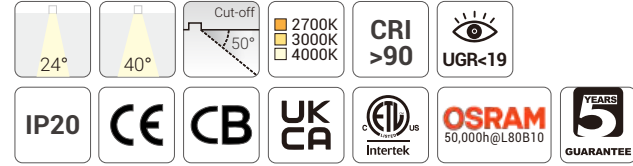

Quick Info

- Ceiling Cut-out: 160x53mm for Trim Version
- OSRAM LED: 11W, CRI>90
- CCT: 2700K, 3000K, 4000K Available as Standard
- Beam Angle: 24°, 40°
- Lumen Output: Up to 750lm System Luminous Flux
- IP Class: IP20
- LED Driver: On-Off, Phase Dim, 1-10V Dim, DALI Dim, Casambi Wireless Dim

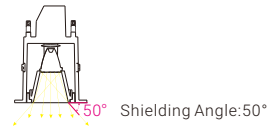
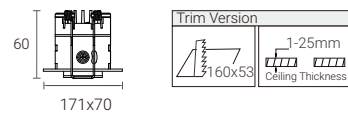

Light Distribution

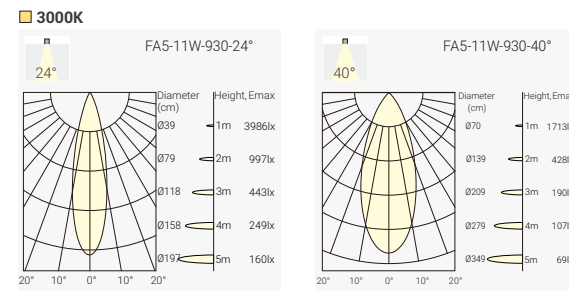

Finish



White Black

Reflector Options



Black Specular

Order Info (FUSION FA5 in White Trim & Black Reflector as an Example)

LED Power	System Power	LED Voltage	LED Current	CRI	CCT	Beam	LED Output	System Output	Code	
11W	13 W	15V	700mA	90	2700K	24°	950lm	650lm	FA5-9272411N-WB	
						40°	950lm	650lm	FA5-9274011N-WB	
						3000K	24°	1050lm	700lm	FA5-9302411N-WB
							40°	1050lm	700lm	FA5-9304011N-WB
						4000K	24°	1150lm	750lm	FA5-9402411N-WB
							40°	1150lm	750lm	FA5-9404011N-WB

Code Remark: N=N(No Driver) F=F(ON-OFF) P=P(Phase Dim) A=A(1-10V Dim) D=D(DALI Dim)

Coding

Model	CRI/ CCT	Beam Angle	LED Power	Control	Finish	Reflector Color	Accessory
FA5	927	24	11	N	W	B	
FUSION FA5	CRI>90/ 2700K	24°	11W	No Driver	White	Black	
	930	40		F	B	S	
	CRI>90/ 3000K	40°		On-Off	Black	Specular	
	940			P			
	CRI>90/ 4000K			Phase Dim			
				A			
				1-10V Dim			
				D			
				DALI Dim			

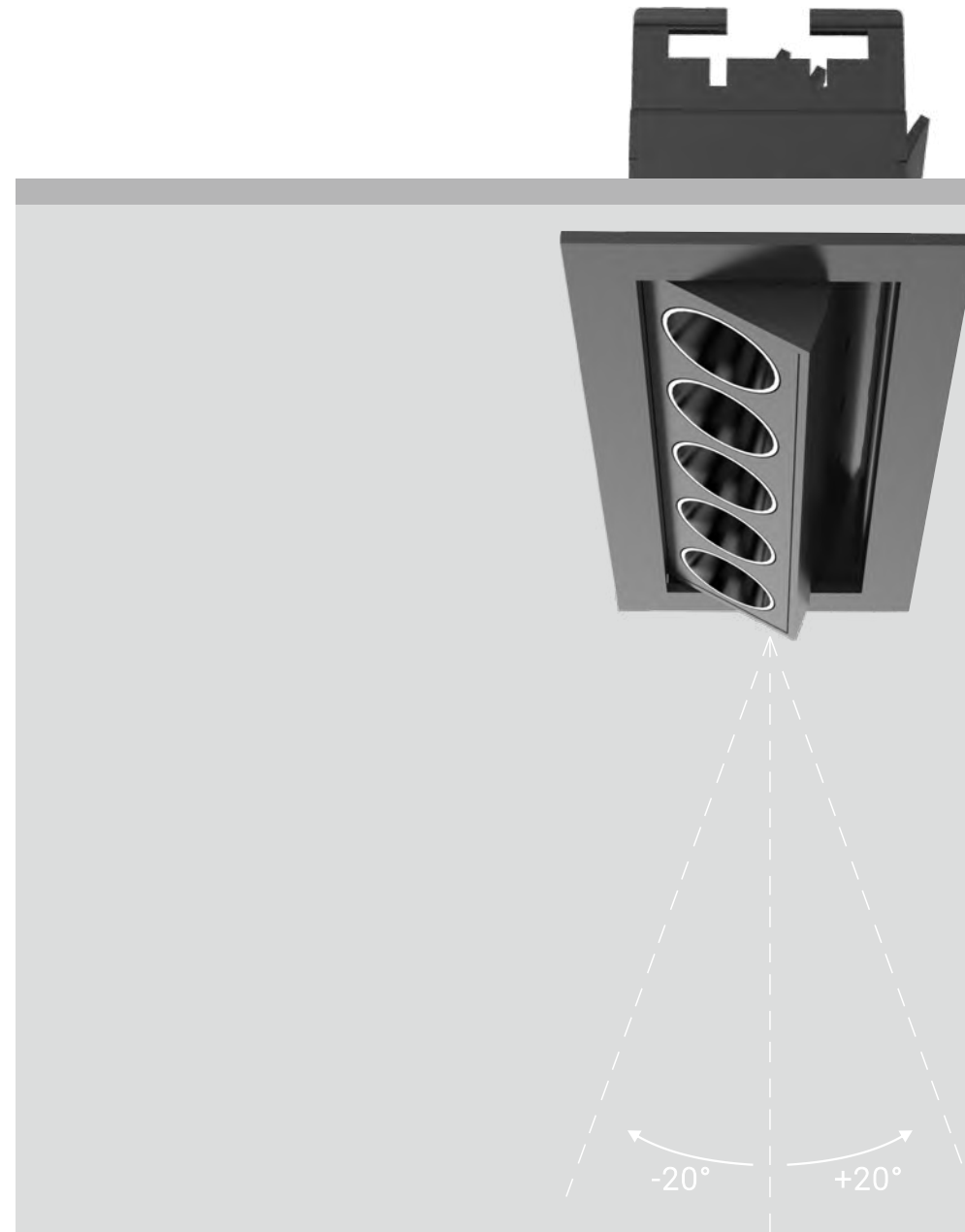

FUSION FA10 – Adjustable LED Downlight

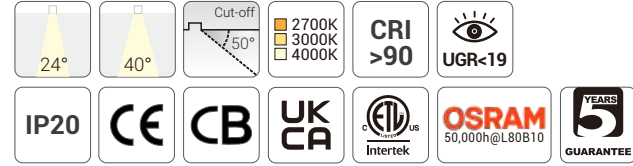

Quick Info

- Ceiling Cut-out: 198x53mm for Trim Version
- OSRAM LED: 22W, CRI>90
- CCT: 2700K, 3000K, 4000K Available as Standard
- Beam Angle: 24°, 40°
- Lumen Output: Up to 1650lm System Luminous Flux
- IP Class: IP20
- LED Driver: On-Off, Phase Dim, 1-10V Dim, DALI Dim, Casambi Wireless Dim

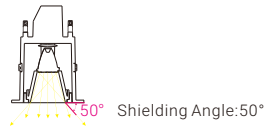
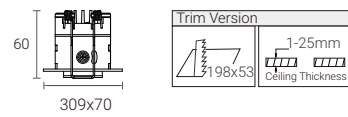

Light Distribution

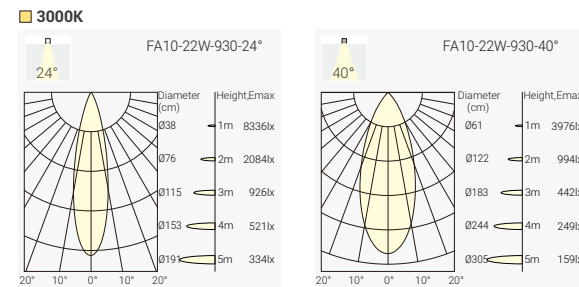

Finish



White



Black

Reflector Options



Black



Specular

Order Info (FUSION FFA10 in White Trim & Black Reflector as an Example)

LED Power	System Power	LED Voltage	LED Current	CRI	CCT	Beam	LED Output	System Output	Code	
22W	24W	30V	700mA	90	2700K	24°	1900lm	1400lm	FA10-9272422N-WB	
						40°	1900lm	1400lm	FA10-9274022N-WB	
						3000K	24°	2050lm	1500lm	FA10-9302422N-WB
							40°	2050lm	1500lm	FA10-9304022N-WB
						4000K	24°	2200lm	1650lm	FA10-9402422N-WB
							40°	2200lm	1650lm	FA10-9404022N-WB

Code Remark: N=N(No Driver) F=F(ON-OFF) P=P(Phase Dim) A=A(1-10V Dim) D=D(DALI Dim)

Coding

Model	CRI/ CCT	Beam Angle	LED Power	Control	Finish	Reflector Color	Accessory
FA10	927	24	22	N	W	B	
FUSION FA10	CRI>90/ 2700K	24°	22W	No Driver	White	Black	
	930	40		F	B	S	
	CRI>90/ 3000K	40°		On-Off	Black	Specular	
	940			P			
	CRI>90/ 4000K			Phase Dim			
				A			
				1-10V Dim			
				D			
				DALI Dim			

Project: Bvlgari Hotel, Shanghai, China



FUSION FW5 – Wall Washer LED Downlight



Quick Info

- Ceiling Cut-out: 144x37mm for Trim Version
- OSRAM LED: 11W, CRI>90
- CCT: 2700K, 3000K, 4000K Available as Standard
- Beam Angle: Wall Washer
- Lumen Output: Up to 550lm System Luminous Flux
- IP Class: IP20
- LED Driver: On-Off, Phase Dim, 1-10V Dim, DALI Dim, Casambi Wireless Dim

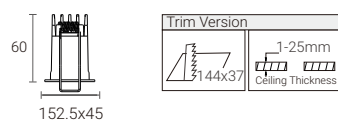

Light Distribution

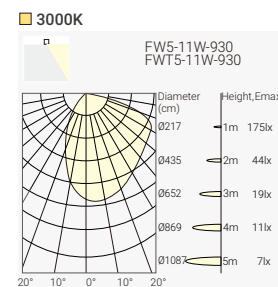

Finish



Order Info (FUSION FW5 in White Trim & Matt Reflector as an Example)

LED Power	System Power	LED Voltage	LED Current	CRI	CCT	Beam	LED Output	System Output	Code
11W	13W	15V	700mA	90	2700K	WW	900lm	450lm	FW5-927WW11N-WM
					3000K	WW	950lm	500lm	FW5-930WW11N-WM
					4000K	WW	1050lm	550lm	FW5-940WW11N-WM

Code Remark: N=N(No Driver) F=F(ON-OFF) P=P(Phase Dim) A=A(1-10V Dim) D=D(DALI Dim)

Trimless Version



FWT5

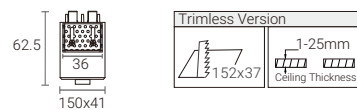

Coding

Model	CRI/ CCT	Beam Angle	LED Power	Control	Finish	Reflector Color	Accessory
FW5 FUSION FW5	927 CRI>90/ 2700K	WW Wall Washer	11 11W	N No Driver	W White	M Matt	
FWT5 FUSION FWT5	930 CRI>90/ 3000K			F On-Off	B Black		
	940 CRI>90/ 4000K			P Phase Dim			
				A 1-10V Dim			
				D DALI Dim			

Project: Oslo Hall, City Hall Gallery, Norway



FUSION FW10 – Wall Washer LED Downlight



Quick Info

- Ceiling Cut-out: 282x37mm for Trim Version
- OSRAM LED: 22W, CRI>90
- CCT: 2700K, 3000K, 4000K Available as Standard
- Beam Angle: Wall Washer
- Lumen Output: Up to 1200lm System Luminous Flux
- IP Class: IP20
- LED Driver: On-Off, Phase Dim, 1-10V Dim, DALI Dim, Casambi Wireless Dim

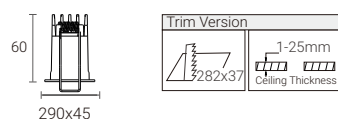

Light Distribution

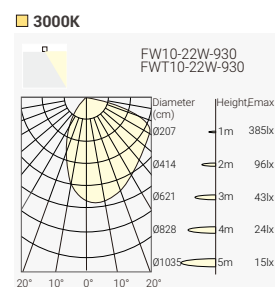

Finish

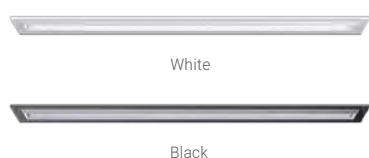

Order Info (FUSION FW10 in White Trim & Black Reflector as an Example)

LED Power	System Power	LED Voltage	LED Current	CRI	CCT	Beam	LED Output	System Output	Code
22W	24W	30V	700mA	90	2700K	WW	2000lm	1000lm	FW10-927WW22N-WM
					3000K	WW	2200lm	1100lm	FW10-930WW22N-WM
					4000K	WW	2400lm	1200lm	FW10-940WW22N-WM

Code Remark: N=N(No Driver) F=F(ON-OFF) P=P(Phase Dim) A=A(1-10V Dim) D=D(DALI Dim)

Trimless Version

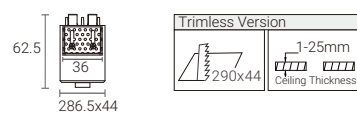

Coding

Model	CRI/ CCT	Beam Angle	LED Power	Control	Finish	Reflector Color	Accessory
FW10 FUSION FW10	927 CRI>90/ 2700K	WW Wall Washer	22 22W	N No Driver	W White	M Matt	
FWTA FUSION FW10	930 CRI>90/ 3000K			F On-Off	B Black		
	940 CRI>90/ 4000K			P Phase Dim			
				A 1-10V Dim			
				D DALI Dim			

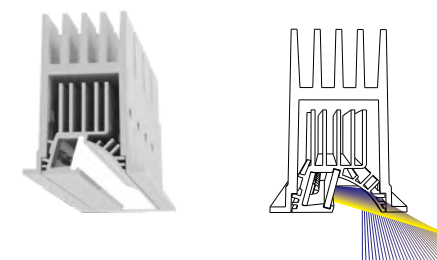

High quality wall washer illumination



FUSION FG5 – General LED Downlight



Quick Info

- Ceiling Cut-out: 144x37mm for Trim Version
- OSRAM LED: 11W, CRI>80, CRI>90
- CCT: 2700K, 3000K, 4000K Available as Standard
- Beam Angle: 75°
- Lumen Output: Up to 400lm System Luminous Flux
- IP Class: IP20
- LED Driver: On-Off, Phase Dim, 1-10V Dim, DALI Dim, Casambi Wireless Dim

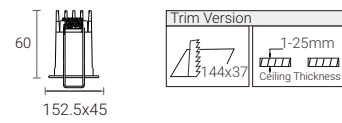

Light Distribution

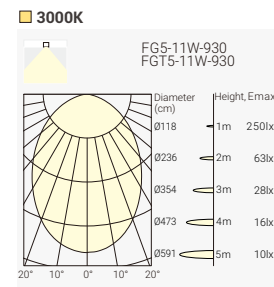

Finish



Order Info (FUSION FG5 in White Trim & Black Reflector as an Example)

LED Power	System Power	LED Voltage	LED Current	CRI	CCT	Beam	LED Output	System Output	Code
11W	13W	15V	700mA	90	2700K	75°	900lm	330lm	FG5-9277511N-WB
					3000K	75°	950lm	350lm	FG5-9277511N-WB
					4000K	75°	1050lm	400lm	FG5-9307511N-WB

Code Remark: N=N(No Driver) F=F(ON-OFF) P=P(Phase Dim) A=A(1-10V Dim) D=D(DALI Dim)

Trimless Version

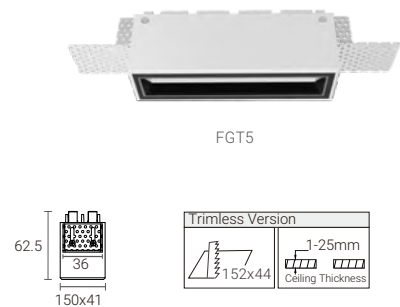

Coding

FG5 - *** ** ** * - * * - *

Model	CRI/ CCT	Beam Angle	LED Power	Control	Finish	Reflector Color	Accessory
FG5 FUSION FG5	927 CRI>90/ 2700K	75 75°	11 11W	N No Driver	W White	B Black	
FGT5 FUSION FGT5	930 CRI>90/ 3000K			F On-Off	B Black		
	940 CRI>90/ 4000K			P Phase Dim			
				A 1-10V Dim			
				D DALI Dim			

FUSION FG10 – General LED Downlight



Quick Info

- Ceiling Cut-out: Ø55mm for Trim Version
- OSRAM LED: 22W, CRI>90
- CCT: 2700K, 3000K, 4000K Available as Standard
- Beam Angle: 75°
- Lumen Output: Up to 850lm System Luminous Flux
- IP Class: IP20
- LED Driver: On-Off, Phase Dim, 1-10V Dim, DALI Dim, Casambi Wireless Dim

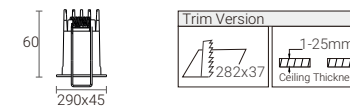

Light Distribution

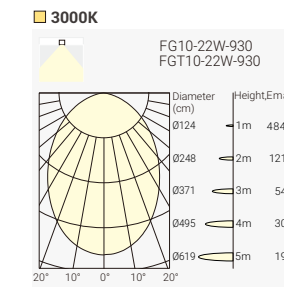

Finish

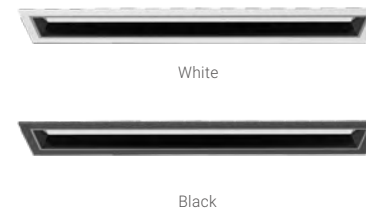

Order Info (FUSION FG10 in White Trim & Black Reflector as an Example)

LED Power	System Power	LED Voltage	LED Current	CRI	CCT	Beam	LED Output	System Output	Code
22W	24W	30V	700mA	90	2700K	75°	2000lm	750lm	FG10-9277522N-WB
					3000K	75°	2200lm	800lm	FG10-9307522N-WB
					4000K	75°	2400lm	850lm	FG10-9407522N-WB

Code Remark: N=N(No Driver) F=F(ON-OFF) P=P(Phase Dim) A=A(1-10V Dim) D=D(DALI Dim)

Trimless Version

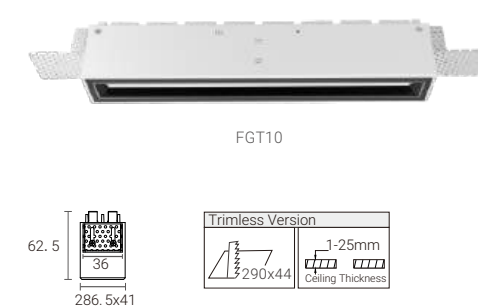

Coding

FG10 - *** ** ** * - * * - *

Model	CRI/ CCT	Beam Angle	LED Power	Control	Finish	Reflector Color	Accessory
FG10 FUSION FG10	927 CRI>90/ 2700K	75 75°	22 22W	N No Driver	W White	B Black	
FGTA FUSION FGT10	930 CRI>90/ 3000K			F On-Off	B Black		
	940 CRI>90/ 4000K			P Phase Dim			
				A 1-10V Dim			
				D DALI Dim			



Diversity Design with Adjustable Spot Light



FUSION FS1 – Adjustable Spotlight



Quick Info

- Ceiling Cut-out: 62x37mm
- OSRAM LED: 2W, CRI>90
- CCT: 2700K, 3000K, 4000K Available as Standard
- Beam Angle: 15°, 30°
- Lumen Output: Up to 160lm System Luminous Flux
- IP Class: IP20
- LED Driver: On-Off, No-Off, 1-10V Dim, DALI Dim

Light Distribution

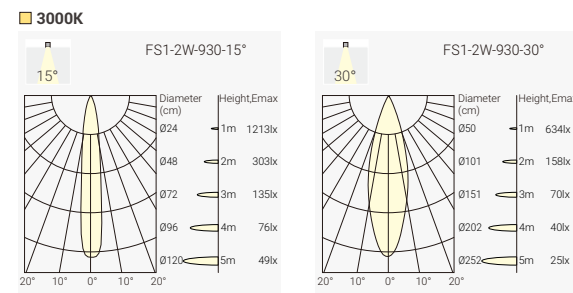
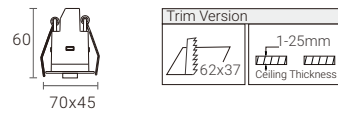

Finish



Order Info (FUSION FS1 in White Finish as an Example)

LED Power	System Power	LED Voltage	LED Current	CRI	CCT	Beam	LED Output	System Output	Code
2W	3W	3V	700mA	90	2700K	15°	200lm	130lm	FS1-9271502N-WN
					3000K	30°	200lm	130lm	FS1-9273002N-WN
					3000K	15°	210lm	140lm	FS1-9301502N-WN
					3000K	30°	210lm	140lm	FS1-9303002N-WN
					4000K	15°	230lm	160lm	FS1-9401502N-WN
					4000K	30°	230lm	160lm	FS1-9403002N-WN

Code Remark: N=N(No Driver) F=F(ON-OFF) A=A(1-10V Dim) D=D(DALI Dim)

Coding

Model	CRI/ CCT	Beam Angle	LED Power	Control	Finish	Reflector Color	Accessory
FS1	927	15	02	N	W	N	
FUSION FS1	CRI>90/ 2700K	15°	2W	No Driver	White	None	
	930	30		F	B		
	CRI>90/ 3000K	30°		On-Off	Black		
	940			A			
	CRI>90/ 4000K			1-10V Dim			
				D			
				DALI Dim			

*In same BRIDGELUX LED chip as FUSION G2 series is optional.

FUSION FS2 – Adjustable Spotlight



Quick Info

- Ceiling Cut-out: 90x37mm
- OSRAM LED: 4W, CRI>90
- CCT: 2700K, 3000K, 4000K Available as Standard
- Beam Angle: 15°, 30°
- Lumen Output: Up to 330lm System Luminous Flux
- IP Class: IP20
- LED Driver: On-Off, Phase Dim, 1-10V Dim, DALI Dim

Light Distribution

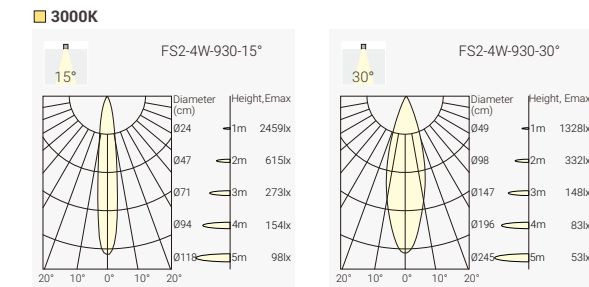
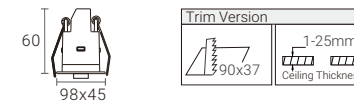

Finish



Order Info (FUSION FS2 in White Finish as an Example)

LED Power	System Power	LED Voltage	LED Current	CRI	CCT	Beam	LED Output	System Output	Code
4W	6W	6V	700mA	90	2700K	15°	400lm	280lm	FS2-9271504N-WN
					3000K	30°	400lm	280lm	FS2-9273004N-WN
					3000K	15°	450lm	300lm	FS2-9301504N-WN
					3000K	30°	450lm	300lm	FS2-9303004N-WN
					4000K	15°	500lm	330lm	FS2-9401504N-WN
					4000K	30°	500lm	330lm	FS2-9403004N-WN

Code Remark: N=N(No Driver) F=F(ON-OFF) P=P(Phase Dim) A=A(1-10V Dim) D=D(DALI Dim)

Coding

Model	CRI/ CCT	Beam Angle	LED Power	Control	Finish	Reflector Color	Accessory
FS2	927	15	04	N	W	N	
FUSION FS2	CRI>90/ 2700K	15°	4W	No Driver	White	None	
	930	30		F	B		
	CRI>90/ 3000K	30°		On-Off	Black		
	940			P			
	CRI>90/ 4000K			Phase Dim			
				A			
				1-10V Dim			
				D			
				DALI Dim			

*In same BRIDGELUX LED chip as FUSION G2 series is optional.

FUSION FS3 – Adjustable Spotlight



Quick Info

- Ceiling Cut-out: 144x37mm for Trim Version
- OSRAM LED: 7W, CRI>90
- CCT: 2700K, 3000K, 4000K Available as Standard
- Beam Angle: 15°, 30°
- Lumen Output: Up to 500lm System Luminous Flux
- IP Class: IP20
- LED Driver: On-Off, Phase Dim, 1-10V Dim, DALI Dim

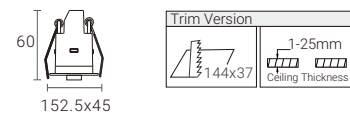

Light Distribution

3000K

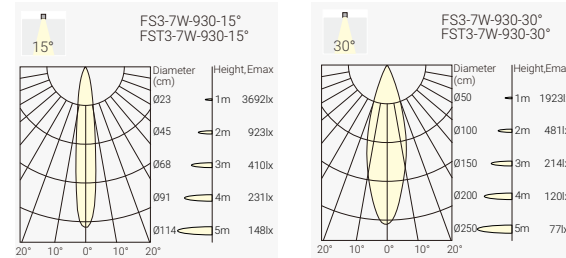

Finish



Order Info (FUSION FS3 in White Finish as an Example)

LED Power	System Power	LED Voltage	LED Current	CRI	CCT	Beam	LED Output	System Output	Code
7W	9W	9V	700mA	90	2700K	15°	600lm	420lm	FS3-9271507N-WN
						30°	600lm	420lm	FS3-9273007N-WN
					3000K	15°	650lm	450lm	FS3-9301507N-WN
						30°	650lm	450lm	FS3-9303007N-WN
					4000K	15°	700lm	500lm	FS3-9401507N-WN
						30°	700lm	500lm	FS3-9403007N-WN

Code Remark: N=N(No Driver) F=F(ON-OFF) P=P(Phase Dim) A=A(1-10V Dim) D=D(DALI Dim)

Coding

Model	CRI/ CCT	Beam Angle	LED Power	Control	Finish	Reflector Color	Accessory
FS3 FUSION FS3	927 CRI>90/ 2700K	15°	07 7W	N No Driver	W White	N None	
FST3 FUSION FST3	930 CRI>90/ 3000K	30°		F On-Off	B Black		
	940 CRI>90/ 4000K			P Phase Dim			
				A 1-10V Dim			
				D DALI Dim			

*In same BRIDGELUX LED chip as FUSION G2 series is optional.

Trimless Version

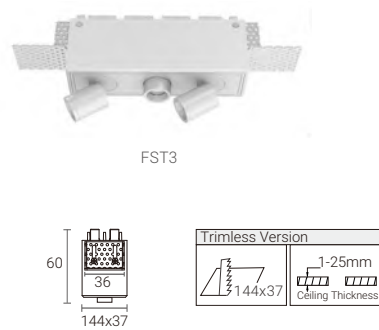

FUSION FS6 – Adjustable Spotlight



Quick Info

- Ceiling Cut-out: 282x37mm for Trim Version
- OSRAM LED: 13W, CRI>90
- CCT: 2700K, 3000K, 4000K Available as Standard
- Beam Angle: 15°, 30°
- Lumen Output: Up to 900lm System Luminous Flux
- IP Class: IP20
- LED Driver: On-Off, Phase Dim, 1-10V Dim, DALI Dim, Casambi Wireless Dim

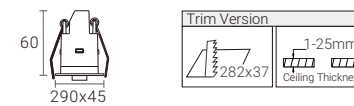

Light Distribution

3000K

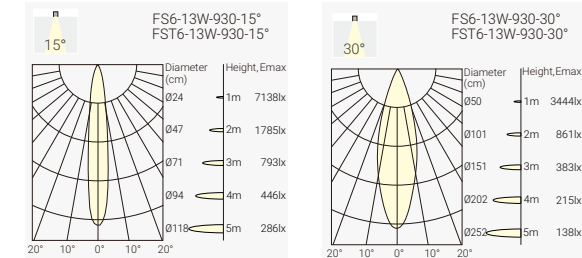

Finish

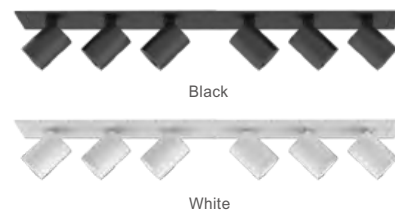

Order Info (FUSION FS6 in White Finish as an Example)

LED Power	System Power	LED Voltage	LED Current	CRI	CCT	Beam	LED Output	System Output	Code
13W	15W	18V	700mA	90	2700K	15°	1200lm	800lm	FS6-9271513N-WN
						30°	1200lm	800lm	FS6-9273013N-WN
					3000K	15°	1300lm	850lm	FS6-9301513N-WN
						30°	1300lm	850lm	FS6-9303013N-WN
					4000K	15°	1400lm	900lm	FS6-9401513N-WN
						30°	1400lm	900lm	FS6-9403013N-WN

Code Remark: N=N(No Driver) F=F(ON-OFF) P=P(Phase Dim) A=A(1-10V Dim) D=D(DALI Dim)

Trimless Version

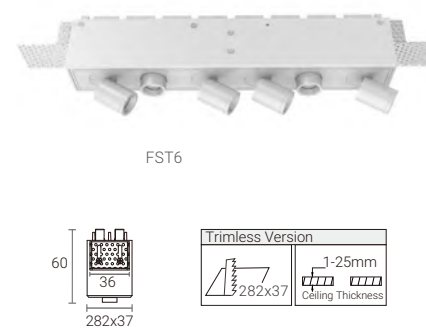

Coding

Model	CRI/ CCT	Beam Angle	LED Power	Control	Finish	Reflector Color	Accessory
FS6 FUSION FS6	927 CRI>90/ 2700K	15°	22 22W	N No Driver	W White	N None	
FST6 FUSION FST6	930 CRI>90/ 3000K	30°		F On-Off	B Black		
	940 CRI>90/ 4000K			P Phase Dim			
				A 1-10V Dim			
				D DALI Dim			

*In same BRIDGELUX LED chip as FUSION G2 series is optional.

FUSION FF3-FS3 – Adjustable Spotlight



Quick Info

- Ceiling Cut-out: 144x37mm for Trim Version
- OSRAM LED: 9W, CRI>90
- CCT: 2700K, 3000K, 4000K Available as Standard
- Beam Angle: 24°, 40°
- Lumen Output: Up to 600lm System Luminous Flux
- IP Class: IP20
- LED Driver: On-Off, Phase Dim, 1-10V Dim, DALI Dim, Casambi Wireless Dim

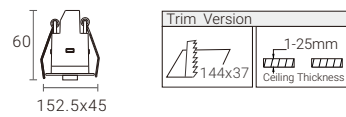

Light Distribution

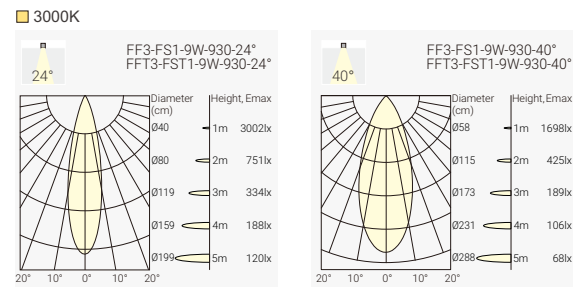

Finish

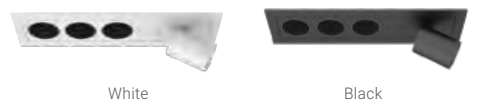

Order Info (FUSION FFS1 in White Finish as an Example)

LED Power	System Power	LED Voltage	LED Current	CRI	CCT	Beam	LED Output	System Output	Code
9W	11W	12 V	700mA	90	2700K	24°	750lm	500lm	FFS1-9272409N-WB
						40°	750lm	500lm	FFS1-9274009N-WB
					3000K	24°	800lm	550lm	FFS1-9302409N-WB
						40°	800lm	550lm	FFS1-9304009N-WB
					4000K	24°	900lm	600lm	FFS1-9402409N-WB
						40°	900lm	600lm	FFS1-9404009N-WB

Code Remark: N=N(No Driver) F=F(ON-OFF) P=P(Phase Dim) A=A(1-10V Dim) D=D(DALI Dim)

Coding

Model	CRI/ CCT	Beam Angle	LED Power	Control	Finish	Reflector Color	Accessory
FFS1 FUSION FFS1	927 CRI>90/ 2700K	24°	09 9W	N No Driver	W White	N None	
FFS3 FUSION FFT3-FST1	930 CRI>90/ 3000K	40°		F On-Off	B Black		
	940 CRI>90/ 4000K			P Phase Dim			
				A 1-10V Dim			
				D DALI Dim			

*In same BRIDGELUX LED chip as FUSION G2 series is optional.

Trimless Version

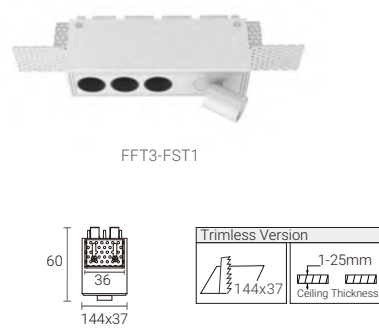

FUSION FF6-FS2 – Adjustable Spotlight



Quick Info

- Ceiling Cut-out: 282x37mm for Trim Version
- OSRAM LED: 17W, CRI>90
- CCT: 2700K, 3000K, 4000K Available as Standard
- Beam Angle: 24°, 40°
- Lumen Output: Up to 1200lm System Luminous Flux
- IP Class: IP20
- LED Driver: On-Off, Phase Dim, 1-10V Dim, DALI Dim, Casambi Wireless Dim

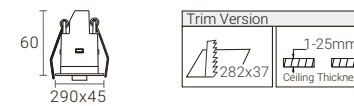

Light Distribution

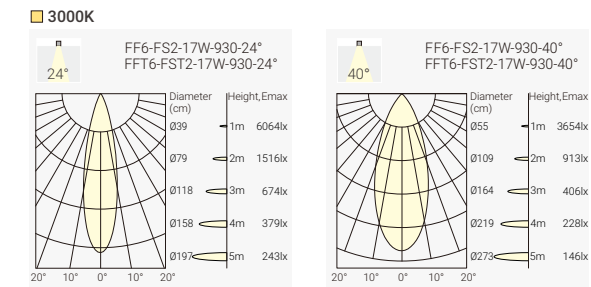

Finish

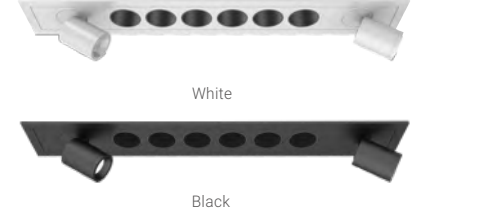

Order Info (FUSION FFS2 in White Finish as an Example)

LED Power	System Power	LED Voltage	LED Current	CRI	CCT	Beam	LED Output	System Output	Code
17W	19W	24 V	700mA	90	2700K	24°	1500lm	1050lm	FFS2-9272417N-WB
						40°	1500lm	1050lm	FFS2-9274017N-WB
					3000K	24°	1600lm	1100lm	FFS2-9302417N-WB
						40°	1600lm	1100lm	FFS2-9304017N-WB
					4000K	24°	1800lm	1200lm	FFS2-9402417N-WB
						40°	1800lm	1200lm	FFS2-9404017N-WB

Code Remark: N=N(No Driver) F=F(ON-OFF) P=P(Phase Dim) A=A(1-10V Dim) D=D(DALI Dim)

Coding

Model	CRI/ CCT	Beam Angle	LED Power	Control	Finish	Reflector Color	Accessory
FFS2 FUSION FFS2	927 CRI>90/ 2700K	24°	17 17W	N No Driver	W White	N None	
FFS4 FUSION FFT6-FST2	930 CRI>90/ 3000K	40°		F On-Off	B Black		
	940 CRI>90/ 4000K			P Phase Dim			
				A 1-10V Dim			
				D DALI Dim			

*In same BRIDGELUX LED chip as FUSION G2 series is optional.

NEW

FUSION G2 Fixed



FUSION G2 FF1
2W/ 200lm @CRI90 3000K



FUSION G2 FF2
4W/ 400lm @CRI90 3000K



FUSION G2 FF3
6W/ 580lm @CRI90 3000K



FUSION G2 FF5
11W/ 900lm @CRI90 3000K



FUSION G2 FF10
22W/ 1900lm @CRI90 3000K

FUSION G2 Trimless Fixed



FUSION G2 FFT5
11W/ 900lm @CRI90 3000K



FUSION G2 FFT10
22W/ 1900lm @CRI90 3000K

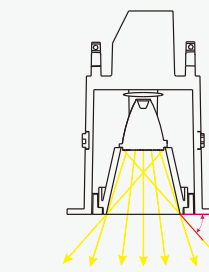

VS

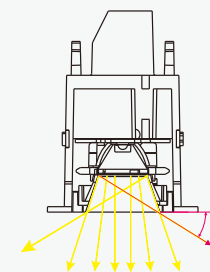

FUSION

LED: OSRAM
Beam: 24°, 40°
Shielding Angle: 50°
UGR: <16

FUSION G2

LED: Bridgelux
Beam: 15°, 24°, 48°, 60°
Shielding Angle: 35°
UGR:<19
Higher Efficiency
Higher R9 Value

FUSION G2 Adjustable



FUSION G2 FA5
11W/ 900lm @CRI90 3000K



FUSION G2 FA10
22W/ 1900lm @CRI90 3000K

Beam Angles

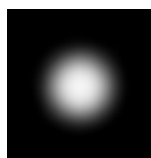

Spot 15°

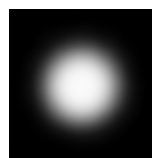

Medium 24°

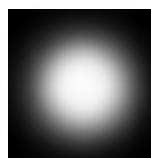

Flood 48°

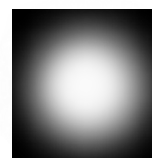

Wide Flood 60°

Finsh



White



Black

FUSION G2 FF1 – Fixed LED Downlight

NEW

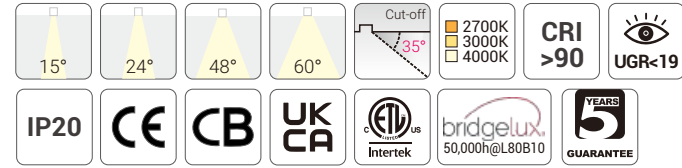

Quick Info

- Ceiling Cut-out: 37x37mm
- OSRAM LED: 2W, CRI>90
- CCT: 2700K, 3000K, 4000K Available as Standard
- Beam Angle: 15°, 24°, 48°, 60°
- Lumen Output: Up to 220lm System Luminous Flux
- IP Class: IP20
- LED Driver: On-Off, Phase Dim, 1-10V Dim, DALI Dim

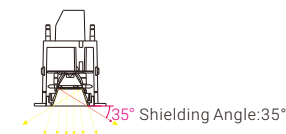
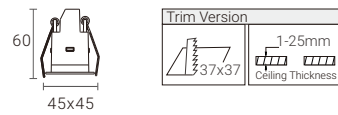

Light Distribution

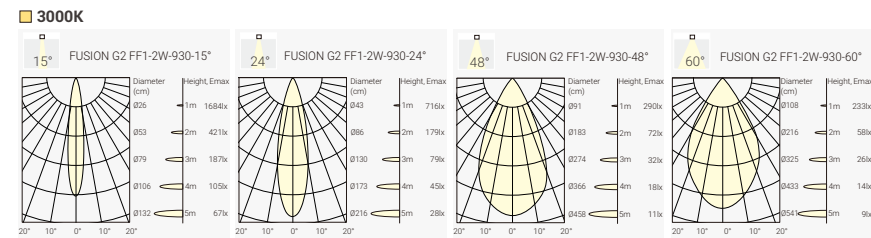

Finish

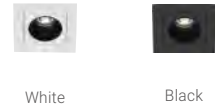

Order Info (FUSION G2 FF1 in White Trim & Black Reflector as an Example)

LED Power	System Power	LED Voltage	LED Current	CRI	CCT	Beam	LED Output	System Output	Code
2W	3W	3V	700mA	90	2700K	15°	230lm	190lm	FF1G2-9271502N-WB
						24°	230lm	180lm	FF1G2-9272402N-WB
						48°	230lm	180lm	FF1G2-9274802N-WB
						60°	230lm	180lm	FF1G2-9276002N-WB
				3000K		15°	240lm	200lm	FF1G2-9301502N-WB
						24°	240lm	190lm	FF1G2-9302402N-WB
						48°	240lm	190lm	FF1G2-9304802N-WB
						60°	240lm	190lm	FF1G2-9306002N-WB
				4000K		15°	260lm	220lm	FF1G2-9401502N-WB
						24°	260lm	200lm	FF1G2-9402402N-WB
						48°	260lm	200lm	FF1G2-9404802N-WB
						60°	260lm	200lm	FF1G2-9406002N-WB

Code Remark: N=N(No Driver) F=F(ON-OFF) P=P(Phase Dim) A=A(1-10V Dim) D=D(DALI Dim)

Coding

Model	CRI/ CCT	Beam Angle	LED Power	Control	Finish	Reflector Color	Accessory
FF1G2	927	15°	02	N	W	B	
FUSION G2 FF1	CRI>90/ 2700K	15°	2W	No Driver	White	Black	
	930	24°		F	B		
	CRI>90/ 3000K	24°		On-Off	Black		
	940	48°		P			
	CRI>90/ 4000K	48°		Phase Dim			
		60°		A			
		60°		1-10V Dim			
				D			
				DALI Dim			

FUSION G2 FF2 – Fixed LED Downlight

NEW

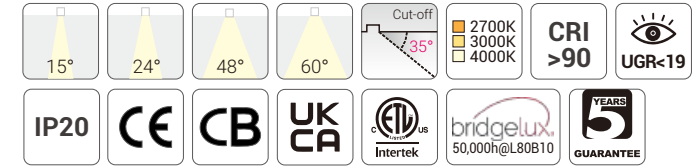

Quick Info

- Ceiling Cut-out: 68x37mm
- OSRAM LED: 4W, CRI>90
- CCT: 2700K, 3000K, 4000K Available as Standard
- Beam Angle: 15°, 24°, 48°, 60°
- Lumen Output: Up to 420lm System Luminous Flux
- IP Class: IP20
- LED Driver: On-Off, Phase Dim, 1-10V Dim, DALI Dim

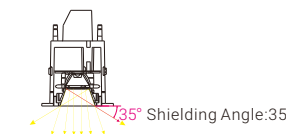
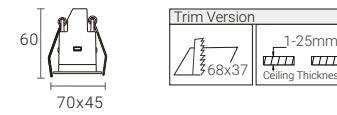

Light Distribution

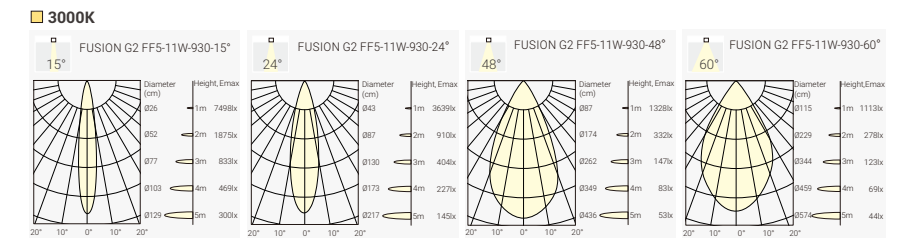

Finish

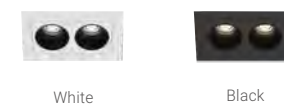

Order Info (FUSION G2 FF2 in White Trim & Black Reflector as an Example)

LED Power	System Power	LED Voltage	LED Current	CRI	CCT	Beam	LED Output	System Output	Code
4W	6W	6V	700mA	90	2700K	15°	460lm	380lm	FF2G2-8271510N-WB
						24°	460lm	350lm	FF2G2-8272410N-WB
						48°	460lm	350lm	FF2G2-8274810N-WB
						60°	460lm	350lm	FF2G2-8276010N-WB
				3000K		15°	480lm	400lm	FF2G2-8301510N-WB
						24°	480lm	360lm	FF2G2-8302410N-WB
						48°	480lm	360lm	FF2G2-8304810N-WB
						60°	480lm	360lm	FF2G2-8306010N-WB
				4000K		15°	510lm	420lm	FF2G2-8401510N-WB
						24°	510lm	380lm	FF2G2-8402410N-WB
						48°	510lm	380lm	FF2G2-8404810N-WB
						60°	510lm	380lm	FF2G2-8406010N-WB

Code Remark: N=N(No Driver) F=F(ON-OFF) P=P(Phase Dim) A=A(1-10V Dim) D=D(DALI Dim)

Coding

Model	CRI/ CCT	Beam Angle	LED Power	Control	Finish	Reflector Color	Accessory
FF2G2	927	15°	04	N	W	B	
FUSION G2 FF2	CRI>90/ 2700K	15°	4W	No Driver	White	Black	
	930	24°		F	B		
	CRI>90/ 3000K	24°		On-Off	Black		
	940	48°		P			
	CRI>90/ 4000K	48°		Phase Dim			
		60°		A			
		60°		1-10V Dim			
				D			
				DALI Dim			

FUSION G2 FF3 – Fixed LED Downlight

NEW

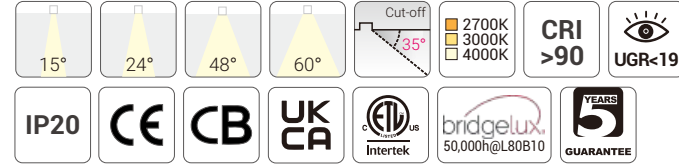

Quick Info

- Ceiling Cut-out: 90x37mm
- OSRAM LED: 7W, CRI>90
- CCT: 2700K, 3000K, 4000K Available as Standard
- Beam Angle: 15°, 24°, 48°, 60°
- Lumen Output: Up to 600lm System Luminous Flux
- IP Class: IP20
- LED Driver: On-Off, Phase Dim, 1-10V Dim, DALI Dim

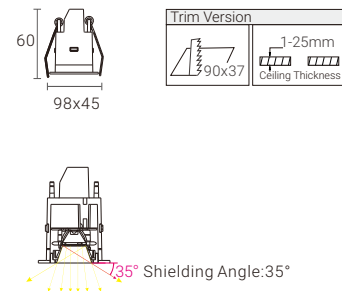

Light Distribution

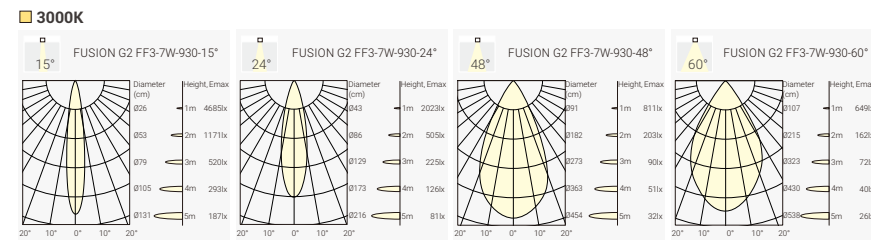

Finish



Order Info (FUSION G2 FF3 in White Trim & Black Reflector as an Example)

LED Power	System Power	LED Voltage	LED Current	CRI	CCT	Beam	LED Output	System Output	Code
7W	9W	9V	700mA	80	2700K	15°	700lm	560lm	FF3G2-9271507N-WB
						24°	700lm	500lm	FF3G2-9272407N-WB
						48°	700lm	500lm	FF3G2-9274807N-WB
						60°	700lm	500lm	FF3G2-9276007N-WB
				3000K	15°	720lm	580lm	550lm	FF3G2-9301507N-WB
					24°	720lm	520lm	520lm	FF3G2-9302407N-WB
					48°	720lm	520lm	520lm	FF3G2-9304807N-WB
					60°	720lm	520lm	520lm	FF3G2-9306007N-WB
				4000K	15°	780lm	600lm	550lm	FF3G2-9401507N-WB
					24°	780lm	550lm	550lm	FF3G2-9402407N-WB
					48°	780lm	550lm	550lm	FF3G2-9404807N-WB
					60°	780lm	550lm	550lm	FF3G2-9406007N-WB

Code Remark: N=N(No Driver) F=F(ON-OFF) P=P(Phase Dim) A=A(1-10V Dim) D=D(DALI Dim)

Coding

FF3G2 - * ** ** * - ***

Model	CRI/ CCT	Beam Angle	LED Power	Control	Finish	Reflector Color	Accessory
FF3G2 FUSION G2 FF3	927 CRI>90/ 2700K	15°	07 7W	N No Driver	W White	B Black	
	930 CRI>90/ 3000K	24°		F On-Off	B Black		
	940 CRI>90/ 4000K	48°		P Phase Dim			
		60°		A 1-10V Dim			
		60°		D DALI Dim			

FUSION G2 FF5 – Fixed LED Downlight

NEW

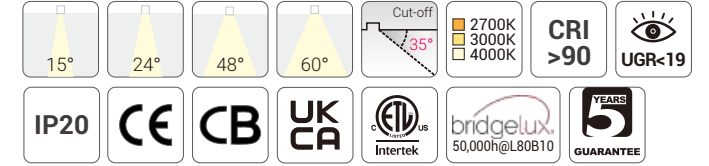

Quick Info

- Ceiling Cut-out: 144x37mm for Trim Version
- OSRAM LED: 11W, CRI>90
- CCT: 2700K, 3000K, 4000K Available as Standard
- Beam Angle: 15°, 24°, 48°, 60°
- Lumen Output: Up to 950lm System Luminous Flux
- IP Class: IP20
- LED Driver: On-Off, Phase Dim, 1-10V Dim, DALI Dim, Casambi Wireless Dim

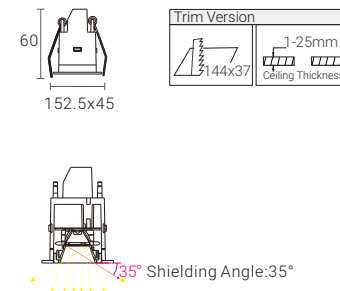

Light Distribution

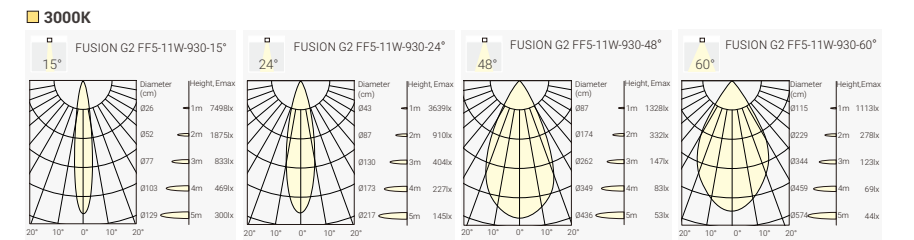

Finish

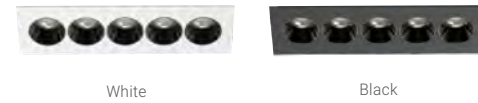

Order Info (FUSION G2 FF5 in White Trim & Black Reflector as an Example)

LED Power	System Power	LED Voltage	LED Current	CRI	CCT	Beam	LED Output	System Output	Code
11W	13W	15V	700mA	90	2700K	15°	1150lm	870lm	FF5G2-9271511N-WB
						24°	1150lm	830lm	FF5G2-9272411N-WB
						48°	1150lm	830lm	FF5G2-9274811N-WB
						60°	1150lm	830lm	FF5G2-9276011N-WB
				3000K	15°	1200lm	900lm	850lm	FF5G2-9301511N-WB
					24°	1200lm	850lm	850lm	FF5G2-9302411N-WB
					48°	1200lm	850lm	850lm	FF5G2-9304811N-WB
					60°	1200lm	850lm	850lm	FF5G2-9306011N-WB
				4000K	15°	1300lm	950lm	900lm	FF5G2-9401511N-WB
					24°	1300lm	900lm	900lm	FF5G2-9402411N-WB
					48°	1300lm	900lm	900lm	FF5G2-9404811N-WB
					60°	1300lm	900lm	900lm	FF5G2-9406011N-WB

Code Remark: N=N(No Driver) F=F(ON-OFF) P=P(Phase Dim) A=A(1-10V Dim) D=D(DALI Dim)

Trimless Version

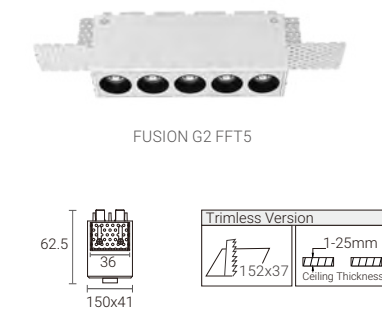

Coding

FF5G2 - * ** ** * - ***

Model	CRI/ CCT	Beam Angle	LED Power	Control	Finish	Reflector Color	Accessory
FF5G2 FUSION G2 FF5	927 CRI>90/ 2700K	15°	11 11W	N No Driver	W White	B Black	
FFT5G2 FUSION G2 FFT5	930 CRI>90/ 3000K	24°		F On-Off	B Black		
	940 CRI>90/ 4000K	48°		P Phase Dim			
		60°		A 1-10V Dim			
		60°		D DALI Dim			

FUSION G2 FF10 – Fixed LED Downlight

NEW

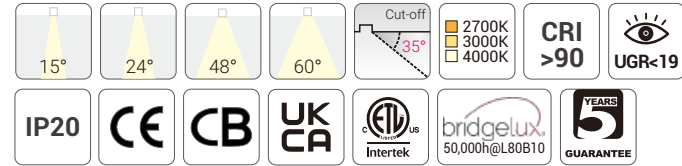
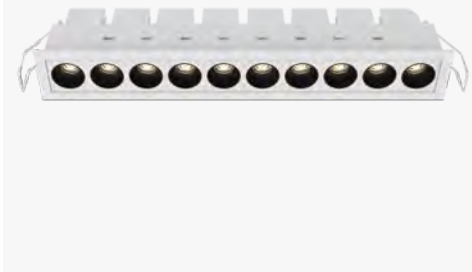

Quick Info

- Ceiling Cut-out: 282x37mm for Trim Version
- OSRAM LED: 22W, CRI>90
- CCT: 2700K, 3000K, 4000K Available as Standard
- Beam Angle: 15°, 24°, 48°, 60°
- Lumen Output: Up to 2000lm System Luminous Flux
- IP Class: IP20
- LED Driver: On-Off, Phase Dim, 1-10V Dim, DALI Dim, Casambi Wireless Dim

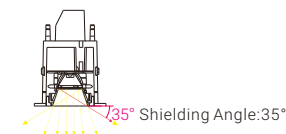
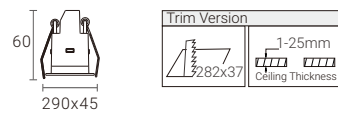

Finish



White



Black

Trimless Version



FUSION G2 FFT10

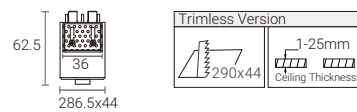

Light Distribution

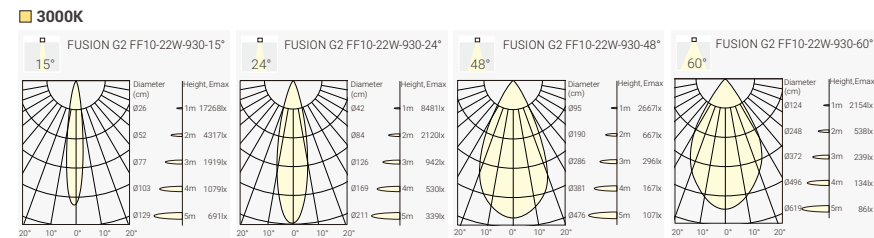

Order Info (FUSION G2 FF10 in White Trim & Black Reflector as an Example)

LED Power	System Power	LED Voltage	LED Current	CRI	CCT	Beam	LED Output	System Output	Code	
22W	24W	30V	700mA	90	2700K	15°	2300lm	1850lm	FF10G2-9271522N-WB	
						24°	2300lm	1800lm	FF10G2-9272422N-WB	
						48°	2300lm	1800lm	FF10G2-9274822N-WB	
						60°	2300lm	1850lm	FF10G2-9276022N-WB	
						3000K	15°	2450lm	1900lm	FF10G2-9301522N-WB
							24°	2450lm	1850lm	FF10G2-9302422N-WB
					48°		2450lm	1850lm	FF10G2-9304822N-WB	
					60°		2450lm	1900lm	FF10G2-9306022N-WB	
					4000K		15°	2600lm	2000lm	FF10G2-9401522N-WB
							24°	2600lm	1950lm	FF10G2-9402422N-WB
						48°	2600lm	1950lm	FF10G2-9404822N-WB	
						60°	2600lm	2000lm	FF10G2-9406022N-WB	

Code Remark: N=N(No Driver) F=F(ON-OFF) P=P(Phase Dim) A=A(1-10V Dim) D=D(DALI Dim)

Coding

Model	CRI/ CCT	Beam Angle	LED Power	Control	Finish	Reflector Color	Accessory
FF10G2	927	15	22	N	W	B	
FUSION G2 FF10	CRI>90/ 2700K	15°	22W	No Driver	White	Black	
FFT10G2	930	24		F	B		
FUSION G2 FFT10	CRI>90/ 3000K	24°		On-Off	Black		
	940	48		P			
	CRI>90/ 4000K	48°		Phase Dim			
		60		A			
		60°		1-10V Dim			
				D			
				DALI Dim			

Project: Eggen Restaurant, Norway

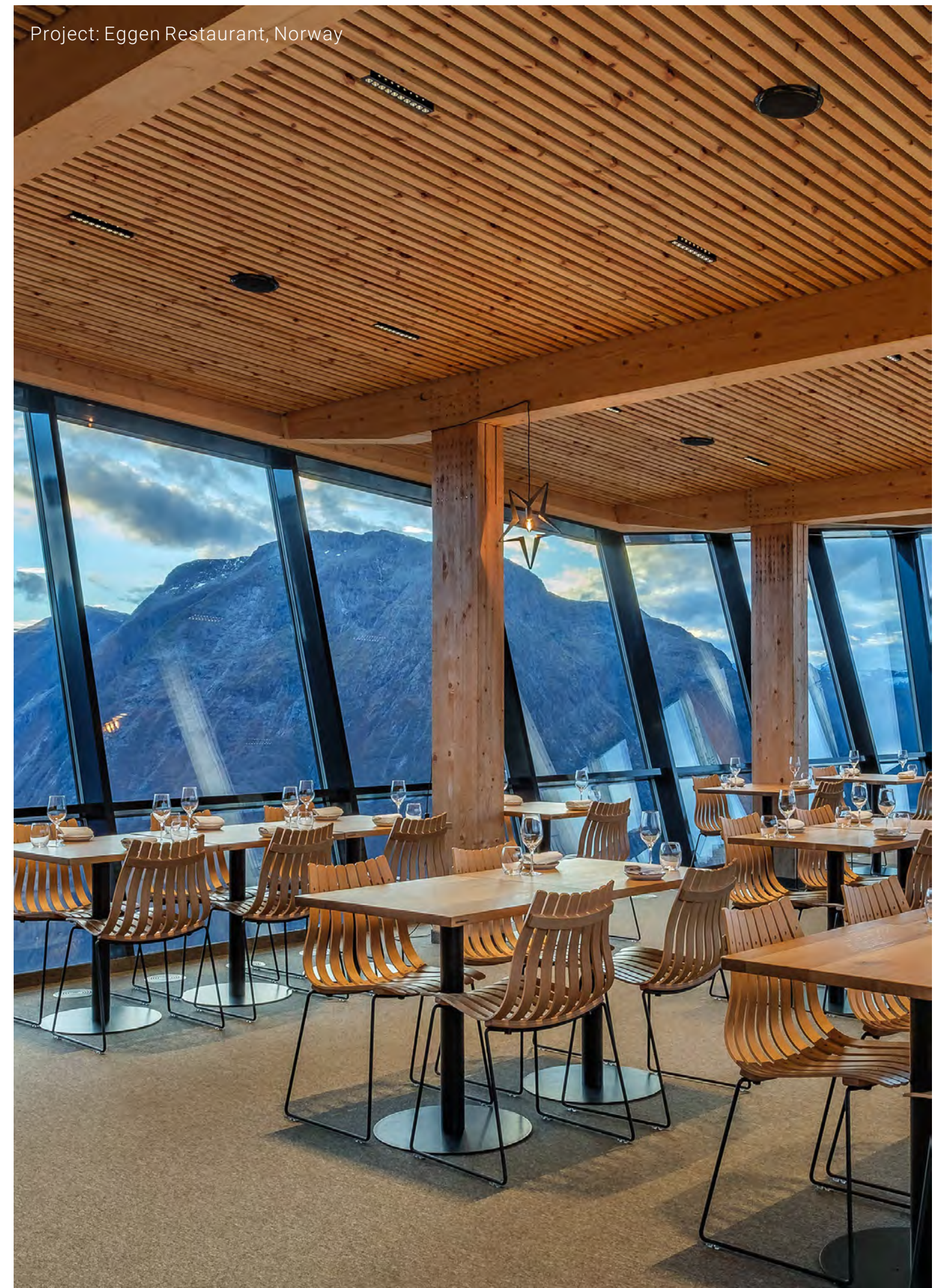

FUSION G2 FA5 – Adjustable LED Downlight

NEW

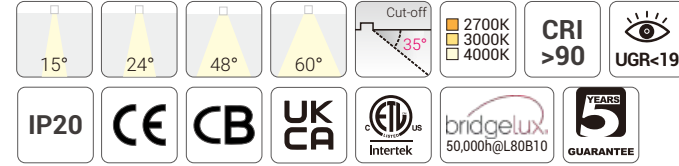

Quick Info

- Ceiling Cut-out: 160x53mm for Trim Version
- OSRAM LED: 11W, CRI>90
- CCT: 2700K, 3000K, 4000K Available as Standard
- Beam Angle: 15°, 24°, 48°, 60°
- Lumen Output: Up to 950lm System Luminous Flux
- IP Class: IP20
- LED Driver: On-Off, Phase Dim, 1-10V Dim, DALI Dim, Casambi Wireless Dim

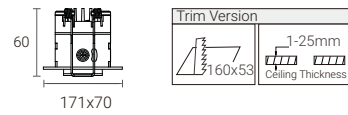

Light Distribution

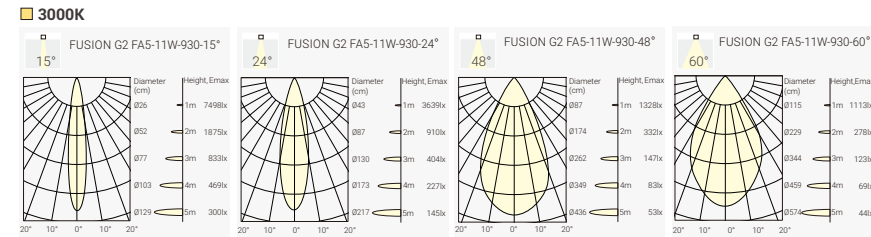

Finish



Order Info (FUSION G2 FA5 in White Trim & Black Reflector as an Example)

LED Power	System Power	LED Voltage	LED Current	CRI	CCT	Beam	LED Output	System Output	Code		
11W	13W	15V	700mA	90	2700K	15°	1150lm	870lm	FA5G2-9271511N-WB		
						24°	1150lm	830lm	FA5G2-9272411N-WB		
						48°	1150lm	830lm	FA5G2-9274811N-WB		
						60°	1150lm	830lm	FA5G2-9276011N-WB		
						3000K	15°	1200lm	900lm	FA5G2-9301511N-WB	
							24°	1200lm	850lm	FA5G2-9302411N-WB	
							48°	1200lm	850lm	FA5G2-9304811N-WB	
							60°	1200lm	850lm	FA5G2-9306011N-WB	
							4000K	15°	1300lm	950lm	FA5G2-9401511N-WB
								24°	1300lm	900lm	FA5G2-9402411N-WB
						48°		1300lm	900lm	FA5G2-9404811N-WB	
						60°		1300lm	900lm	FA5G2-9406011N-WB	

Code Remark: N=N(No Driver) F=F(ON-OFF) P=P(Phase Dim) A=A(1-10V Dim) D=D(DALI Dim)

Coding

Model	CRI/ CCT	Beam Angle	LED Power	Control	Finish	Reflector Color	Accessory
FA5G2	927	15°	11	N	W	B	
FUSION G2 FA5	CRI>90/ 2700K	15°	11W	No Driver	White	Black	
	930	24°		F	B		
	CRI>90/ 3000K	24°		On-Off	Black		
	940	48°		P			
	CRI>90/ 4000K	48°		Phase Dim			
		60°		A			
		60°		1-10V Dim			
				D			
				DALI Dim			

FUSION G2 FA10 – Adjustable LED Downlight

NEW

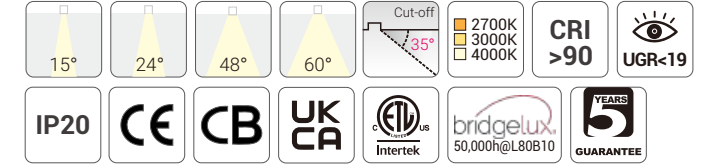

Quick Info

- Ceiling Cut-out: 198x53mm for Trim Version
- OSRAM LED: 22W, CRI>90
- CCT: 2700K, 3000K, 4000K Available as Standard
- Beam Angle: 15°, 24°, 48°, 60°
- Lumen Output: Up to 2000lm System Luminous Flux
- IP Class: IP20
- LED Driver: On-Off, Phase Dim, 1-10V Dim, DALI Dim, Casambi Wireless Dim

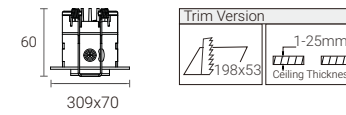

Light Distribution

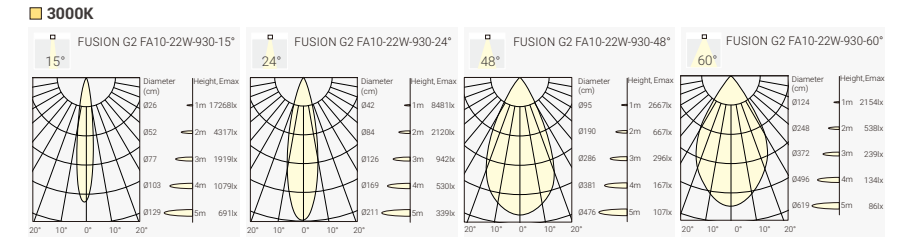

Finish

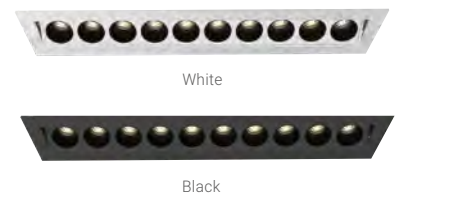

Order Info (FUSION G2 FA10 in White Trim & Black Reflector as an Example)

LED Power	System Power	LED Voltage	LED Current	CRI	CCT	Beam	LED Output	System Output	Code		
22W	24W	30V	700mA	90	2700K	15°	2300lm	1850lm	FA10G2-9271522N-WB		
						24°	2300lm	1800lm	FA10G2-9272422N-WB		
						48°	2300lm	1800lm	FA10G2-9274822N-WB		
						60°	2300lm	1850lm	FA10G2-9276022N-WB		
						3000K	15°	2450lm	1900lm	FA10G2-9301522N-WB	
							24°	2450lm	1850lm	FA10G2-9302422N-WB	
							48°	2450lm	1850lm	FA10G2-9304822N-WB	
							60°	2450lm	1900lm	FA10G2-9306022N-WB	
							4000K	15°	2600lm	2000lm	FA10G2-9401522N-WB
								24°	2600lm	1950lm	FA10G2-9402422N-WB
						48°		2600lm	1950lm	FA10G2-9404822N-WB	
						60°		2600lm	2000lm	FA10G2-9406022N-WB	

Code Remark: N=N(No Driver) F=F(ON-OFF) P=P(Phase Dim) A=A(1-10V Dim) D=D(DALI Dim)

Coding

Model	CRI/ CCT	Beam Angle	LED Power	Control	Finish	Reflector Color	Accessory
FA10G2	927	15°	22	N	W	B	
FUSION G2 FA10	CRI>90/ 2700K	15°	22W	No Driver	White	Black	
	930	24°		F	B		
	CRI>90/ 3000K	24°		On-Off	Black		
	940	48°		P			
	CRI>90/ 4000K	48°		Phase Dim			
		60°		A			
		60°		1-10V Dim			
				D			
				DALI Dim			

FUSION

Linear System

Modular design flexible linear profile system
Light line with 50mm profile width, customized lengths
Pendant, surface, trimless recessed, trim recessed
Opal, accent light, spotlight, wall washer optics
Can also put FUSION downlights into profile
On-Off, Phase Dim, 1-10V Dim, DALI Dim



FUSION Linear System – Modular Design Flexible Linear Profile System

Project: Office Shire House, U.K.



Project: TEM head office, Čatež, Slovenia

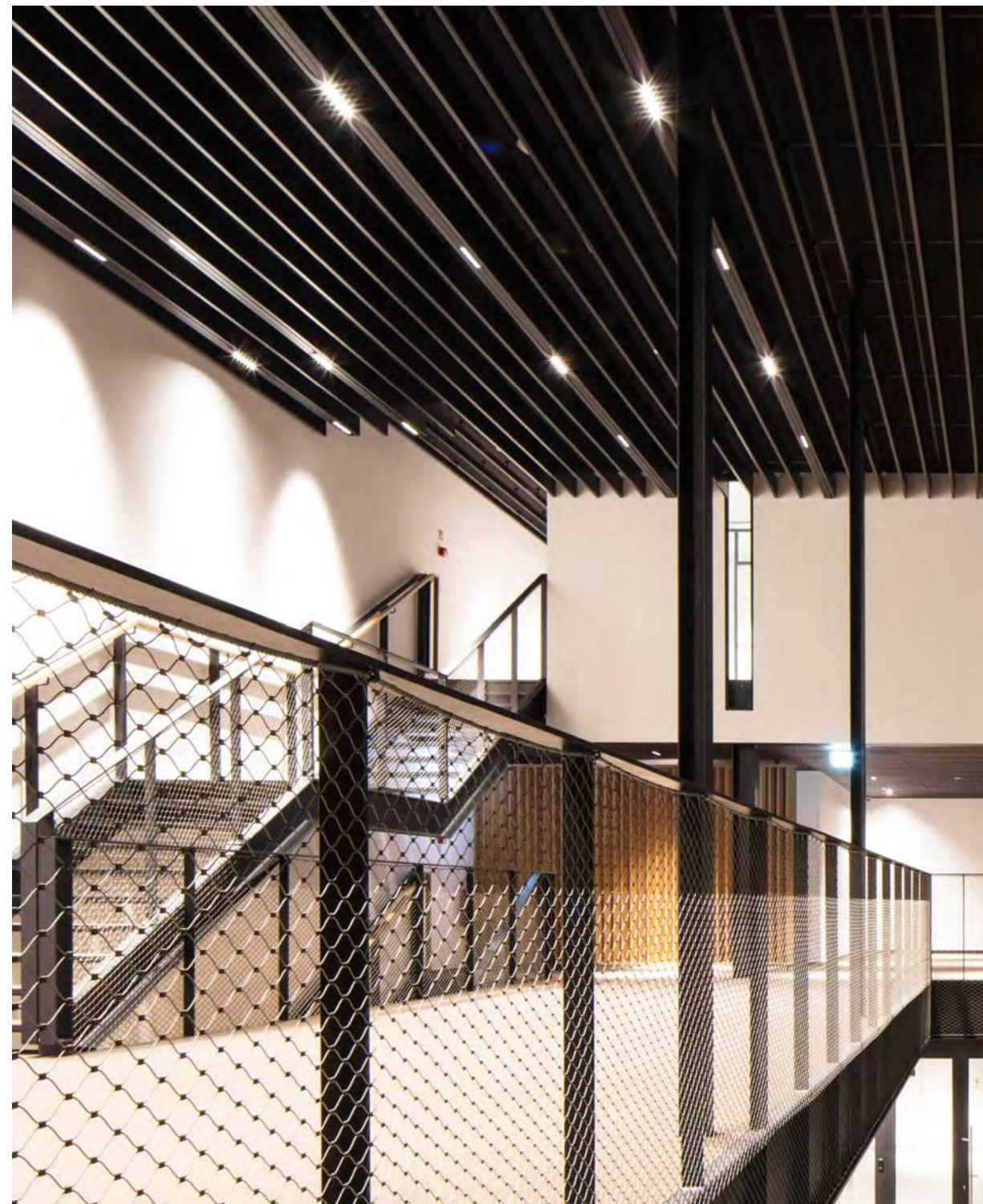

FUSION Linear System – Modular Design Flexible Linear Profile System

Project: Skyline Hill, Germany



FUSION Linear System – Modular Design Flexible Linear Profile System

Project: Office Les Macons Parisiens, France



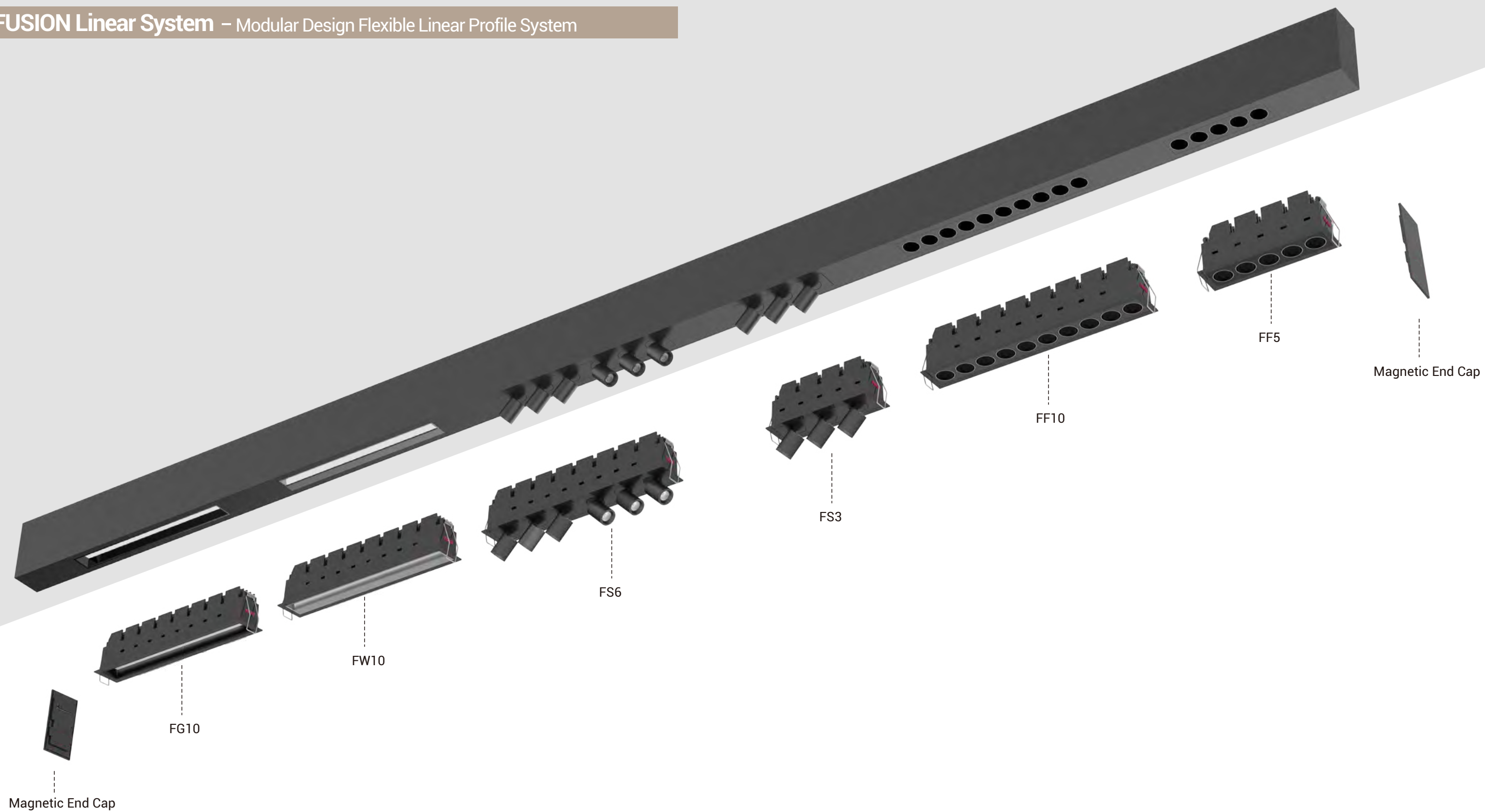

- Suspended, surface mounted and recessed mounted luminaires.
- Easy and unlimited length adjustment, seamless connection.
- Can be used as single fixed / general light / spotlight / wall washer / MIXED.
- Modular profile design with no visible screws, standard length 1.2m & 1.5m.
- Aluminum profile, color choices white / black.
- Suspended luminaire with 2000mm cable suspension, tool free height adjustment.
- High visual comfort, UGR < 19.
- LED 3000K / 4000K, binning ≤ 3 step MacAdam, CRI 80 / 19.

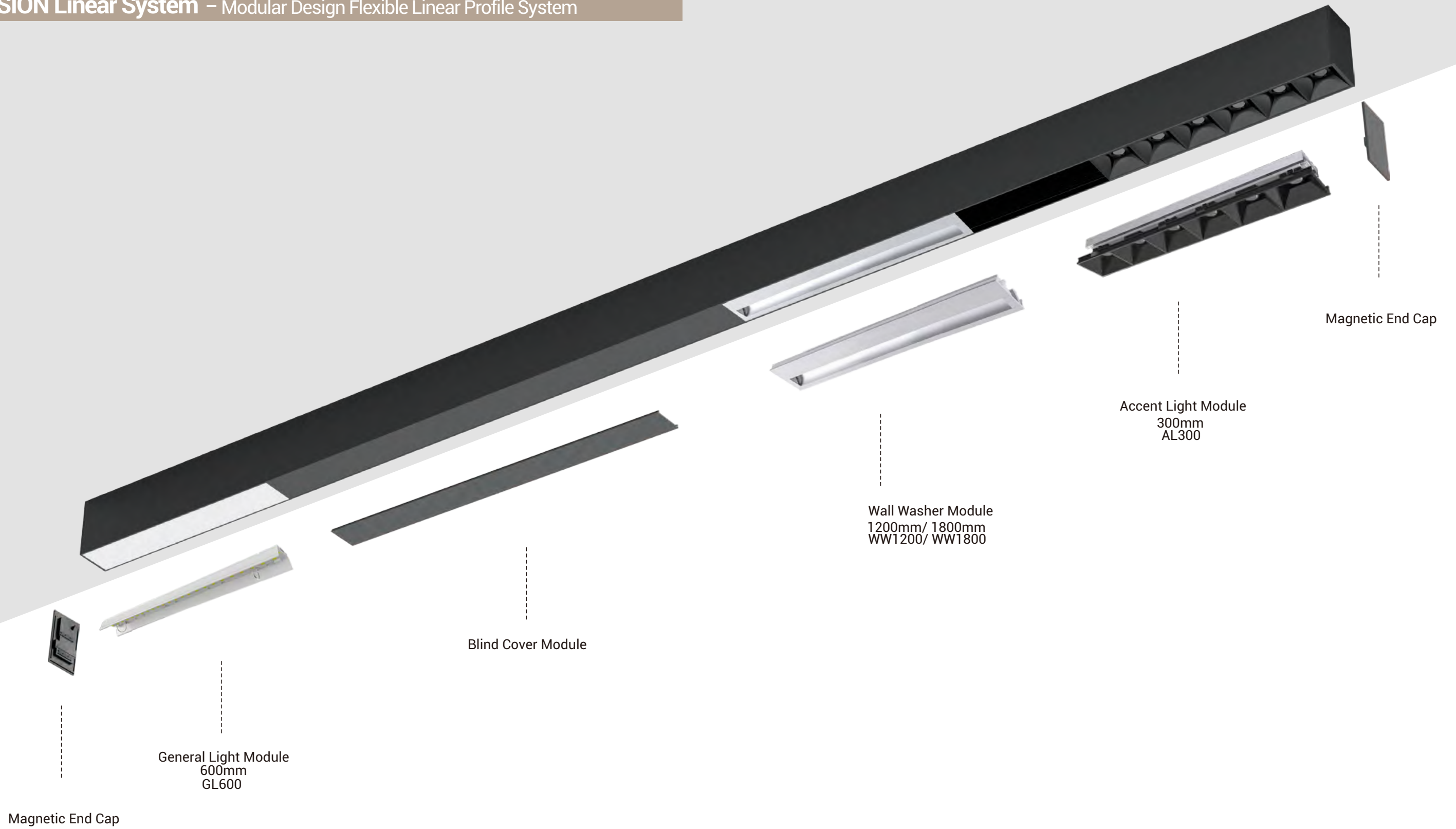

- Schönes Profilsystem aus Aluminiumdruckguss und mit 50 mm Breite
- Verschiedenste Lichtmodule für beste und individuelle Lichtlösungen
- Akzent-, Allgemein- und Spotbeleuchtung – auch Wall washer Modul vorhanden
- Komplette werkzeuglose Montage
- Standard und kundenspezifische Längen
- Magnetische Endkappen – keine Schrauben sichtbar

- Profile system made of extruded aluminium with 50mm width.
- Various lighting modules with multiple lighting applications.
- General light, accent light, wall washer and spotlight module for choice.
- Tool-free inserts mounting by clip-in mechanism.
- Standard and customized length of module and cover for high precise system.
- Magnetic end cap without fixing screws.

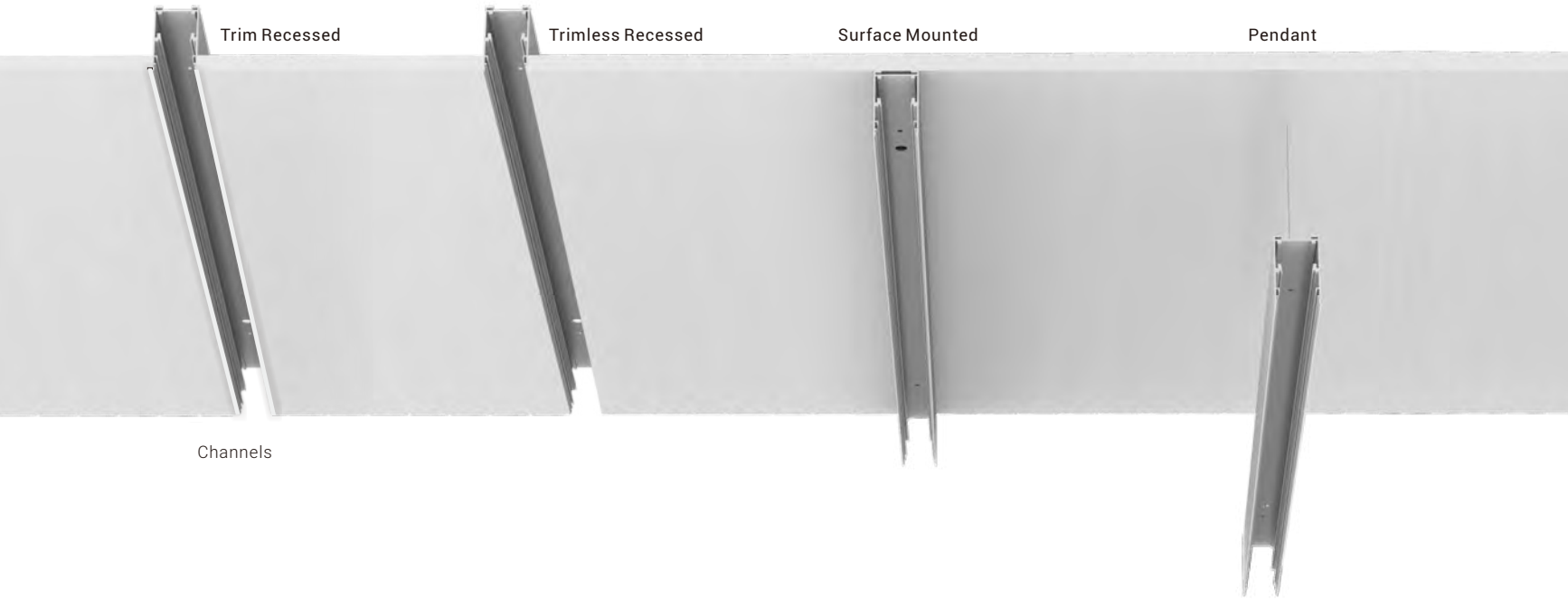

Channels

Inserts

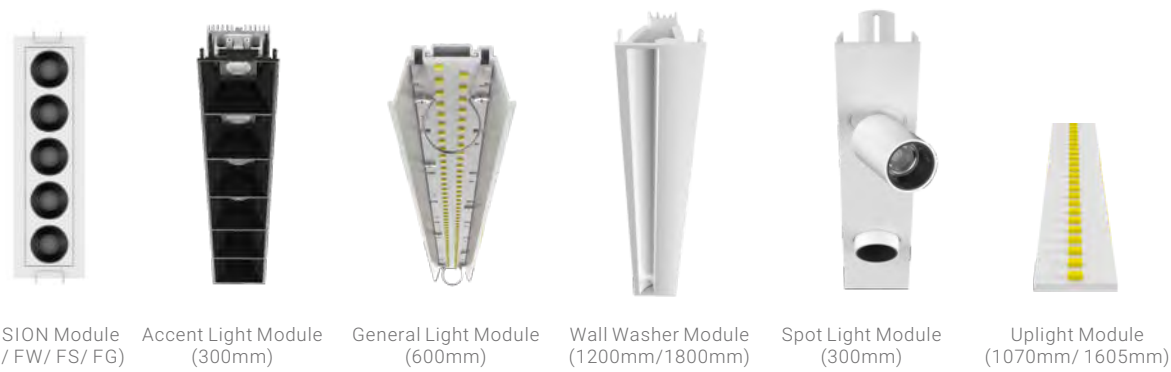

Covers



Mounting Kits

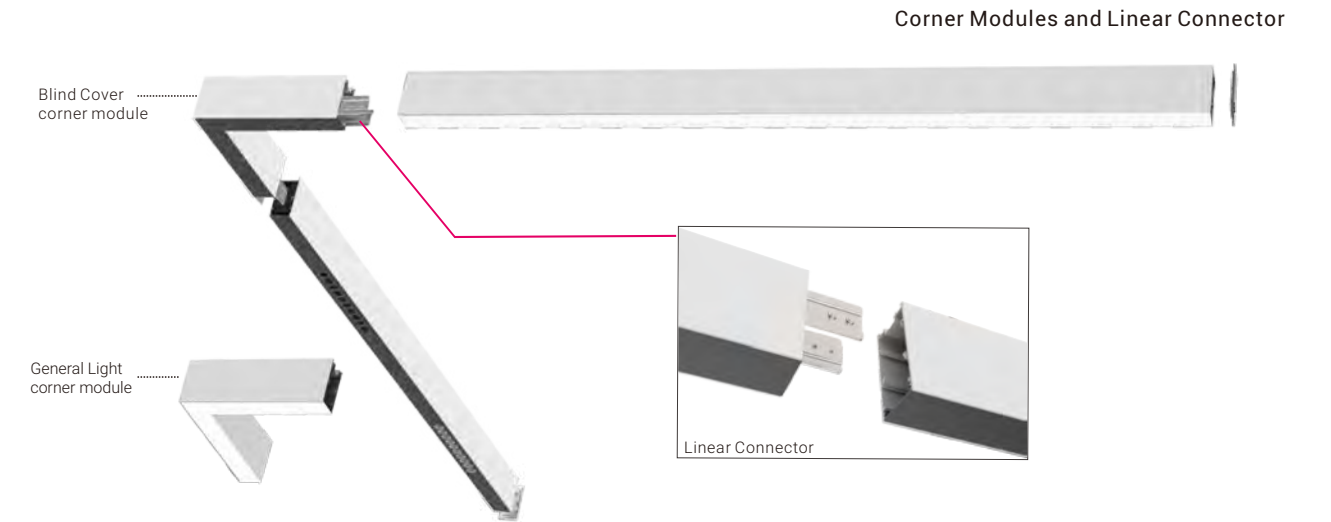

Corner Modules and Linear Connector

System details

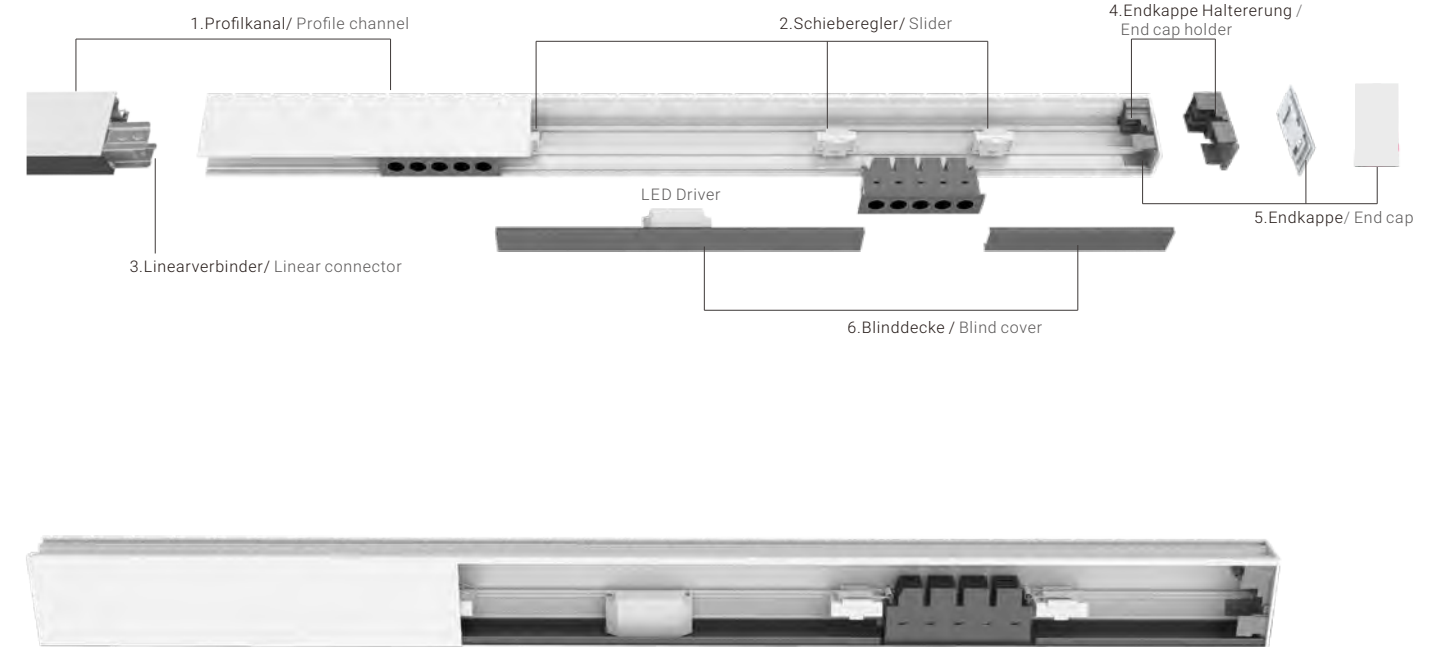

Intelligentes Linear-Profildesign
Einfachste Installation der Fusion-Einbauleuchte in den Profilkanal

Smart linear profile design
Easy to install fusion downlight into profile channel

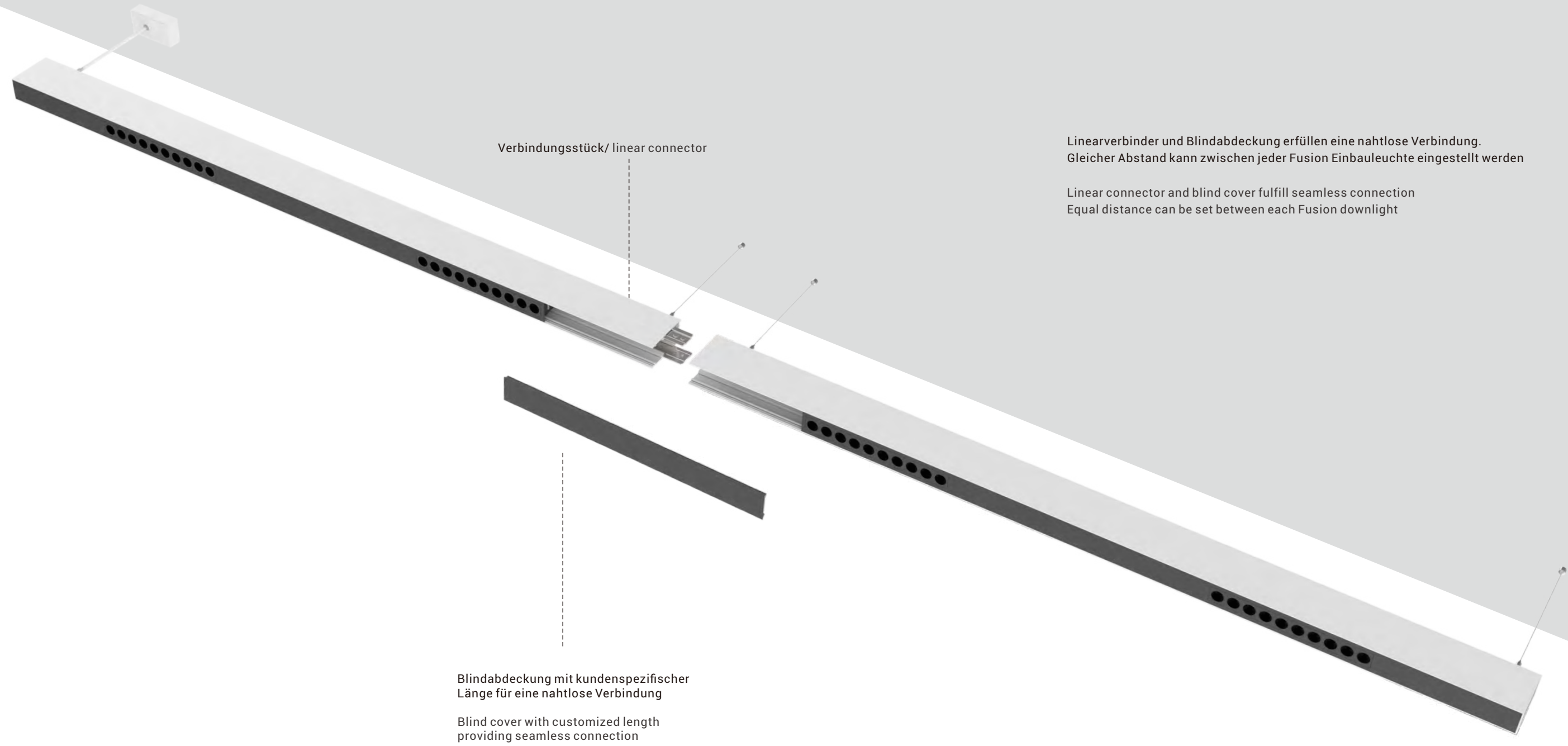

FUSION Linear System – General Light Module

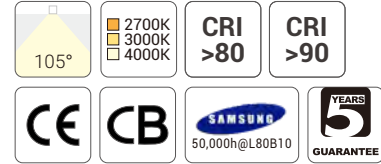

Quick Info

- Linkable General Light Module
- General Light Version also Available
- SAMSUNG LED: 11W, 16W, CRI>80, CRI>90
- CCT: 2700K, 3000K, 4000K Available as Standard
- Beam Angle: 105°
- Lumen Output: Up to 1900lm System Luminous Flux
- LED Driver: ON-OFF, Phase Dim, 1-10V Dim, DALI Dim

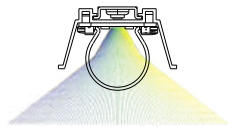
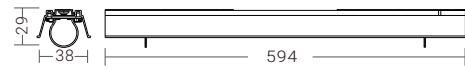

Light Distribution

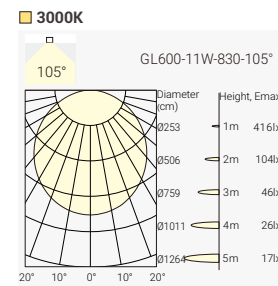

Order Info

LED Power	System Power	LED Voltage	LED Current	CRI	CCT	Beam	LED Output	System Output	Code	
11W	12W	46V	250mA	80	2700K	105°	1600lm	1200lm	GL600-11W-827-105°N	
						3000K	1700lm	1300lm	GL600-11W-830-105°N	
						4000K	1800lm	1400lm	GL600-11W-840-105°N	
						90	2700K	1500lm	1100lm	GL600-11W-927-105°N
							3000K	1600lm	1200lm	GL600-11W-930-105°N
							4000K	1700lm	1300lm	GL600-11W-940-105°N
16W	18W	46V	300mA	80	2700K	105°	2100lm	1700lm	GL600-16W-827-105°N	
						3000K	2200lm	1800lm	GL600-16W-830-105°N	
						4000K	2400lm	1900lm	GL600-16W-840-105°N	
						90	2700K	1900lm	1600lm	GL600-16W-927-105°N
							3000K	2000lm	1700lm	GL600-16W-930-105°N
							4000K	2200lm	1900lm	GL600-16W-940-105°N

Code Remark: N=N(No Driver) F=F(ON-OFF) P=P(Phase Dim) A=A(1-10V Dim) D=D(DALI Dim)

FUSION Linear System – Wall Washer Light Module

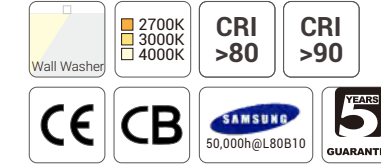

Quick Info

- Wall Wash Light Module
- SAMSUNG LED: 22W, 32W, 48W, CRI>80, CRI>90
- CCT: 2700K, 3000K, 4000K Available as Standard
- Beam Angle: Wall washer
- Lumen Output: Up to 3700lm System Luminous Flux
- LED Driver: ON-OFF, Phase Dim, 1-10V Dim, DALI Dim

Light Distribution

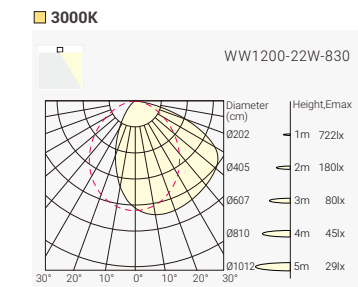
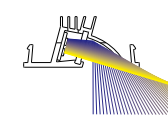
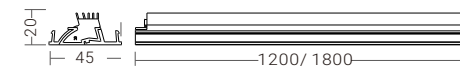

Order Info

LED Power	System Power	LED Voltage	LED Current	CRI	CCT	Beam	LED Output	System Output	Code	
22W	26W	46V	500mA	80	2700K	WW	3200lm	1700lm	WW1200-22W-827N	
						3000K	3400lm	1800lm	WW1200-22W-830N	
						4000K	3600lm	1900lm	WW1200-22W-840N	
						90	2700K	3000lm	1500lm	WW1200-22W-927N
							3000K	3200lm	1600lm	WW1200-22W-930N
							4000K	3400lm	1700lm	WW1200-22W-940N
32W	36W	46V	700mA	80	2700K	WW	4600lm	2300lm	WW1200-32W-827N	
						3000K	4800lm	2500lm	WW1200-32W-830N	
						4000K	5000lm	2700lm	WW1200-32W-840N	
						90	2700K	4000lm	2000lm	WW1200-32W-927N
							3000K	4200lm	2200lm	WW1200-32W-930N
							4000K	4400lm	2400lm	WW1200-32W-940N
32W	36W	46V	700mA	80	2700K	WW	4600lm	2500lm	WW1800-32W-827N	
						3000K	4800lm	2700lm	WW1800-32W-830N	
						4000K	5000lm	2900lm	WW1800-32W-840N	
						90	2700K	4000lm	2100lm	WW1800-32W-927N
							3000K	4200lm	2300lm	WW1800-32W-930N
							4000K	4400lm	2500lm	WW1800-32W-940N
48W	52W	46V	700+350mA	80	2700K	WW	6200lm	3300lm	WW1800-48W-827N	
						3000K	6400lm	3500lm	WW1800-48W-830N	
						4000K	6600lm	3700lm	WW1800-48W-840N	
						90	2700K	5500lm	2900lm	WW1800-48W-927N
							3000K	5700lm	3100lm	WW1800-48W-930N
							4000K	5900lm	3300lm	WW1800-48W-940N

Code Remark: N=N(No Driver) F=F(ON-OFF) P=P(Phase Dim) A=A(1-10V Dim) D=D(DALI Dim)

FUSION Linear System – SL300-1S-4W Adjustable Spotlight Module

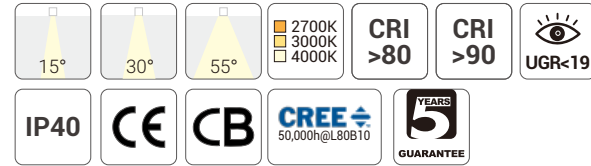

Quick Info

- Adjustable Spotlight Module
- CREE LED: 4W, CRI>80, CRI>90
- CCT: 2700K, 3000K, 4000K Available as Standard
- Beam Angle: 15°, 30°, 55°
- Lumen Output: Up to 420lm System Luminous Flux
- LED Driver: ON-OFF, Phase Dim, 1-10V Dim, DALI Dim

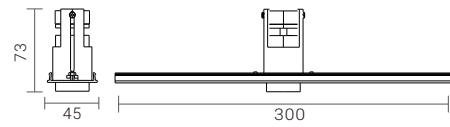

Light Distribution

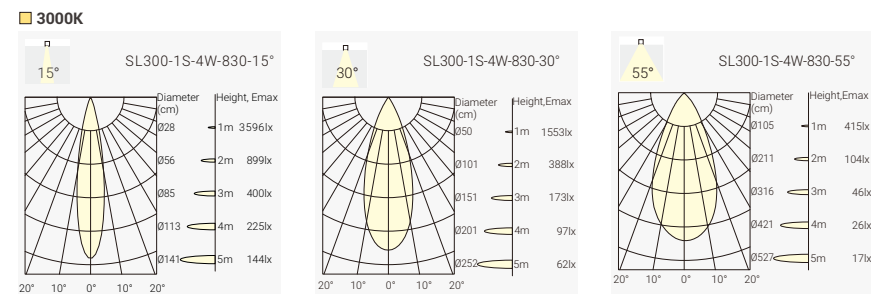

Order Info

LED Power	System Power	LED Voltage	LED Current	CRI	CCT	Beam	LED Output	System Output	Code
4W	6W	12 V	350mA	80	2700K	15°	470lm	350lm	SL300-1S-4W-827-15°*N
						30°	470lm	350lm	SL300-1S-4W-827-30°*N
						55°	470lm	350lm	SL300-1S-4W-827-55°*N
					3000K	15°	500lm	380lm	SL300-1S-4W-830-15°*N
						30°	500lm	380lm	SL300-1S-4W-830-30°*N
						55°	500lm	380lm	SL300-1S-4W-830-55°*N
					4000K	15°	550lm	420lm	SL300-1S-4W-840-15°*N
						30°	550lm	420lm	SL300-1S-4W-840-30°*N
						55°	550lm	420lm	SL300-1S-4W-840-55°*N

Code Remark: N=N(No Driver) F=F(ON-OFF) P=P(Phase Dim) A=A(1-10V Dim) D=D(DALI Dim)

FUSION Linear System – SL300-2S-8W Adjustable Spotlight Module

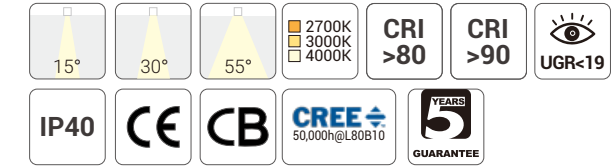

Quick Info

- Adjustable Spotlight Module
- CREE LED: 8W, CRI>80, CRI>90
- CCT: 2700K, 3000K, 4000K Available as Standard
- Beam Angle: 15°, 30°, 55°
- Lumen Output: Up to 750lm System Luminous Flux
- LED Driver: ON-OFF, Phase Dim, 1-10V Dim, DALI Dim

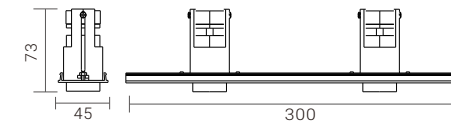

Light Distribution

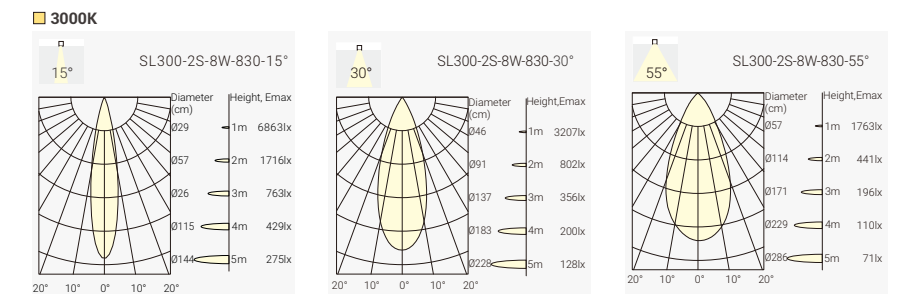

Order Info

LED Power	System Power	LED Voltage	LED Current	CRI	CCT	Beam	LED Output	System Output	Code
8W	10W	24 V	350mA	80	2700K	15°	850lm	650lm	SL300-2S-8W-827-15°*N
						30°	850lm	650lm	SL300-2S-8W-827-30°*N
						55°	850lm	650lm	SL300-2S-8W-827-55°*N
					3000K	15°	900lm	700lm	SL300-2S-8W-830-15°*N
						30°	900lm	700lm	SL300-2S-8W-830-30°*N
						55°	900lm	700lm	SL300-2S-8W-830-55°*N
					4000K	15°	950lm	750lm	SL300-2S-8W-840-15°*N
						30°	950lm	750lm	SL300-2S-8W-840-30°*N
						55°	950lm	750lm	SL300-2S-8W-840-55°*N

Code Remark: N=N(No Driver) F=F(ON-OFF) P=P(Phase Dim) A=A(1-10V Dim) D=D(DALI Dim)

FUSION Linear System – SL450-3S-13W Adjustable Spotlight Module

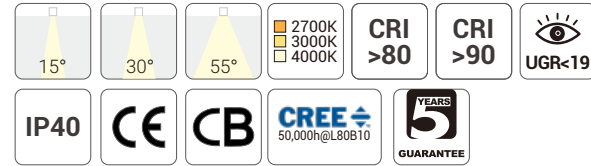

Quick Info

- Adjustable Spotlight Module
- CREE LED: 13W, CRI>80, CRI>90
- CCT: 2700K, 3000K, 4000K Available as Standard
- Beam Angle: 15°, 30°, 55°
- Lumen Output: Up to 1100lm System Luminous Flux
- LED Driver: ON-OFF, Phase Dim, 1-10V Dim, DALI Dim

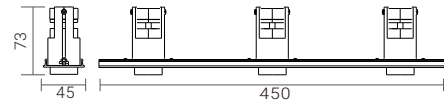

Light Distribution

■ 3000K Per Single Spot:

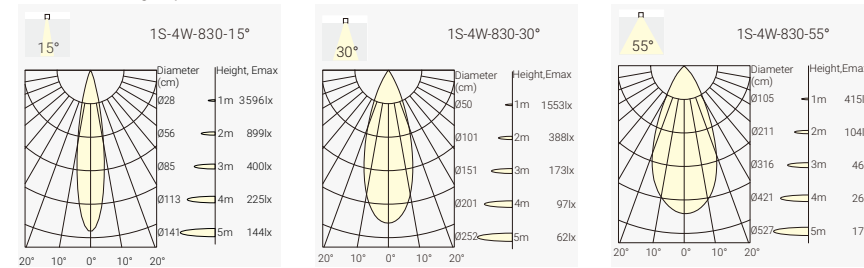

Order Info

LED Power	System Power	LED Voltage	LED Current	CRI	CCT	Beam	LED Output	System Output	Code
13W	15W	36 V	350mA	80	2700K	15°	1200lm	950lm	SL450-3S-13W-827-15°*N
						30°	1200lm	950lm	SL450-3S-13W-827-30°*N
						55°	1200lm	950lm	SL450-3S-13W-827-55°*N
					3000K	15°	1300lm	1000lm	SL450-3S-13W-830-15°*N
						30°	1300lm	1000lm	SL450-3S-13W-830-30°*N
						55°	1300lm	1000lm	SL450-3S-13W-830-55°*N
					4000K	15°	1400lm	1100lm	SL450-3S-13W-840-15°*N
						30°	1400lm	1100lm	SL450-3S-13W-840-30°*N
						55°	1400lm	1100lm	SL450-3S-13W-840-55°*N

Code Remark: N=N(No Driver) F=F(ON-OFF) P=P(Phase Dim) A=A(1-10V Dim) D=D(DALI Dim)

FUSION Linear System – AL300-13W Accent Light Module

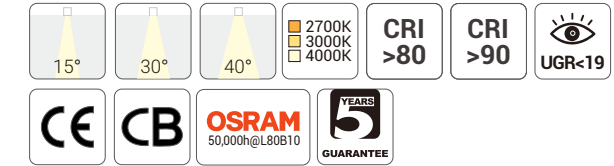

Quick Info

- Accent Light Module
- OSRAM LED: 13W, CRI>80, CRI>90
- CCT: 2700K, 3000K, 4000K Available as Standard
- Beam Angle: 15°, 30°, 40°
- Lumen Output: Up to 1300lm System Luminous Flux
- LED Driver: No Driver, ON-OFF, Phase Dim, 1-10V Dim, DALI Dim

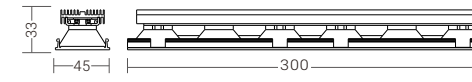

Light Distribution

■ 3000K

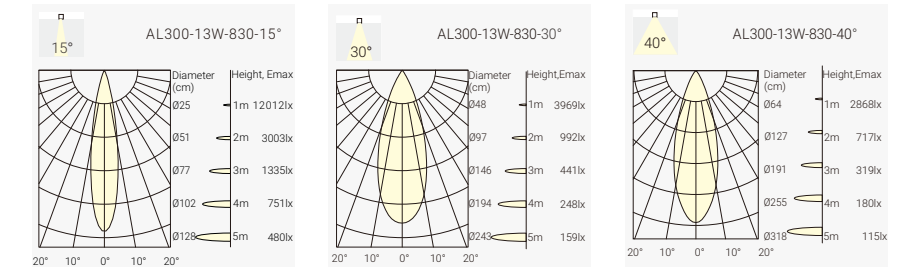

Order Info

LED Power	System Power	LED Voltage	LED Current	CRI	CCT	Beam	LED Output	System Output	Code
13W	15W	18 V	700mA	80	2700K	15°	1300lm	1000lm	AL300-13W-827-15°*N
						30°	1300lm	1000lm	AL300-13W-827-30°*N
						40°	1300lm	1100lm	AL300-13W-827-40°*N
					3000K	15°	1400lm	1100lm	AL300-13W-830-15°*N
						30°	1400lm	1100lm	AL300-13W-830-30°*N
						40°	1400lm	1200lm	AL300-13W-830-40°*N
					4000K	15°	1500lm	1200lm	AL300-13W-840-15°*N
						30°	1500lm	1200lm	AL300-13W-840-30°*N
						40°	1500lm	1300lm	AL300-13W-840-40°*N

Code Remark: N=N(No Driver) F=F(ON-OFF) P=P(Phase Dim) A=A(1-10V Dim) D=D(DALI Dim)

FUSION Linear System – UL1200-11W/ UL1800-16W Uplight Module

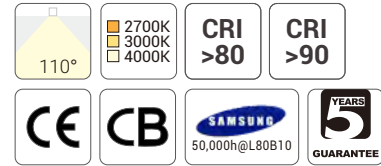

Quick Info

- Uplight Module
- SAMSUNG LED: 11W, 16W, CRI>80, CRI>90
- CCT: 2700K, 3000K, 4000K Available as Standard
- Beam Angle: 110°
- Lumen Output: Up to 2400lm System Luminous Flux
- LED Driver: ON-OFF, Phase Dim, 1-10V Dim, DALI Dim

Light Distribution

■ 3000K Per Single Spot:

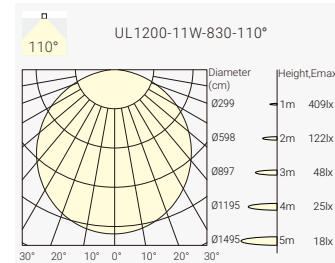

Order Info

LED Power	System Power	LED Voltage	LED Current	CRI	CCT	Beam	LED Output	System Output	Code
11W	13W	46 V	250mA	80	2700K	110°	1700lm	1500lm	UL1200-11W-827-110*N
					3000K	110°	1800lm	1600lm	UL1200-11W-830-110*N
					4000K	110°	1900lm	1700lm	UL1200-11W-840-110*N
16W	18W	46 V	350mA	80	2700K	110°	2300lm	2000lm	UL1800-16W-827-110*N
					3000K	110°	2500lm	2200lm	UL1800-16W-830-110*N
					4000K	110°	2700lm	2400lm	UL1800-16W-840-110*N

Code Remark: N=N(No Driver) F=F(ON-OFF) P=P(Phase Dim) A=A(1-10V Dim) D=D(DALI Dim)



Installation Type: Pendant with Uplight

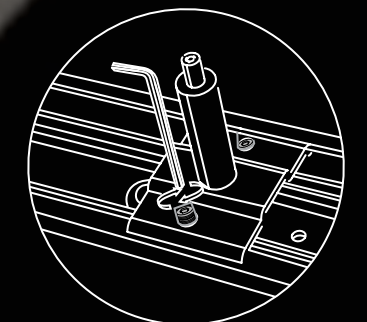

FUSION Linear System – Linear Downlight Profile System



Quick Info

- Linear Accent Light Profile System
- OSRAM LED: 44W, 22W, CRI>80, CRI>90
- CCT: 2700K, 3000K, 4000K Available as Standard
- Beam Angle: 24°, 40° (FUSION G2 in 15°, 24°, 48°, 60°)
- Lumen Output: Up to 3800lm System Luminous Flux
- Mounting Type: Pendant, Surface mounted, Trimless Recessed, Trim Recessed
- LED Driver: ON-OFF, Phase Dim, 1-10V Dim, DALI Dim

Light Distribution

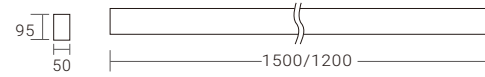

3000K

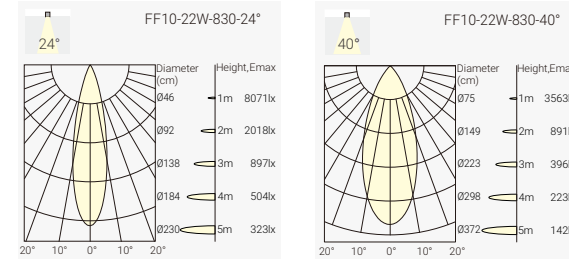

Order Info (in Black Housing as an Example)

LED Power	System Power	LED Voltage	LED Current	CRI	CCT	Beam	LED Output	System Output	Length	Code		
44W	48W	31+31V	700mA	80	2700K	24°	5000lm	3400lm	1500mm	FL1500(X)2*FF10-48W-82724F-BB		
						40°	5000lm	3400lm	1500mm	FL1500(X)2*FF10-48W-82740F-BB		
						3000K	24°	5200lm	3600lm	1500mm	FL1500(X)2*FF10-48W-83024F-BB	
							40°	5200lm	3600lm	1500mm	FL1500(X)2*FF10-48W-83040F-BB	
							4000K	24°	5600lm	3800lm	1500mm	FL1500(X)2*FF10-48W-84024F-BB
								40°	5600lm	3800lm	1500mm	FL1500(X)2*FF10-48W-84040F-BB
22W	26W	16+16V	700mA	80	2700K	24°	2400lm	1700lm	1200mm	FL1200(X)2*FF5-26W-82724F-BB		
						40°	2400lm	1700lm	1200mm	FL1200(X)2*FF5-26W-82740F-BB		
						3000K	24°	2600lm	1800lm	1200mm	FL1200(X)2*FF5-26W-83024F-BB	
							40°	2600lm	1800lm	1200mm	FL1200(X)2*FF5-26W-83040F-BB	
							4000K	24°	2800lm	1900lm	1200mm	FL1200(X)2*FF5-26W-84024F-BB
								40°	2800lm	1900lm	1200mm	FL1200(X)2*FF5-26W-84040F-BB

Code Remark: (X)=P (Pendant) (X)=S (Surface mounted) (X)=T (Trimless Recessed) (X)=F (Trim Recessed)
 Code Remark: F=F(ON-OFF) P=P(Phase Dim) A=A(1-10V Dim) D=D(DALI Dim)

Project: TEM Head Office, Čatež, Slovenia

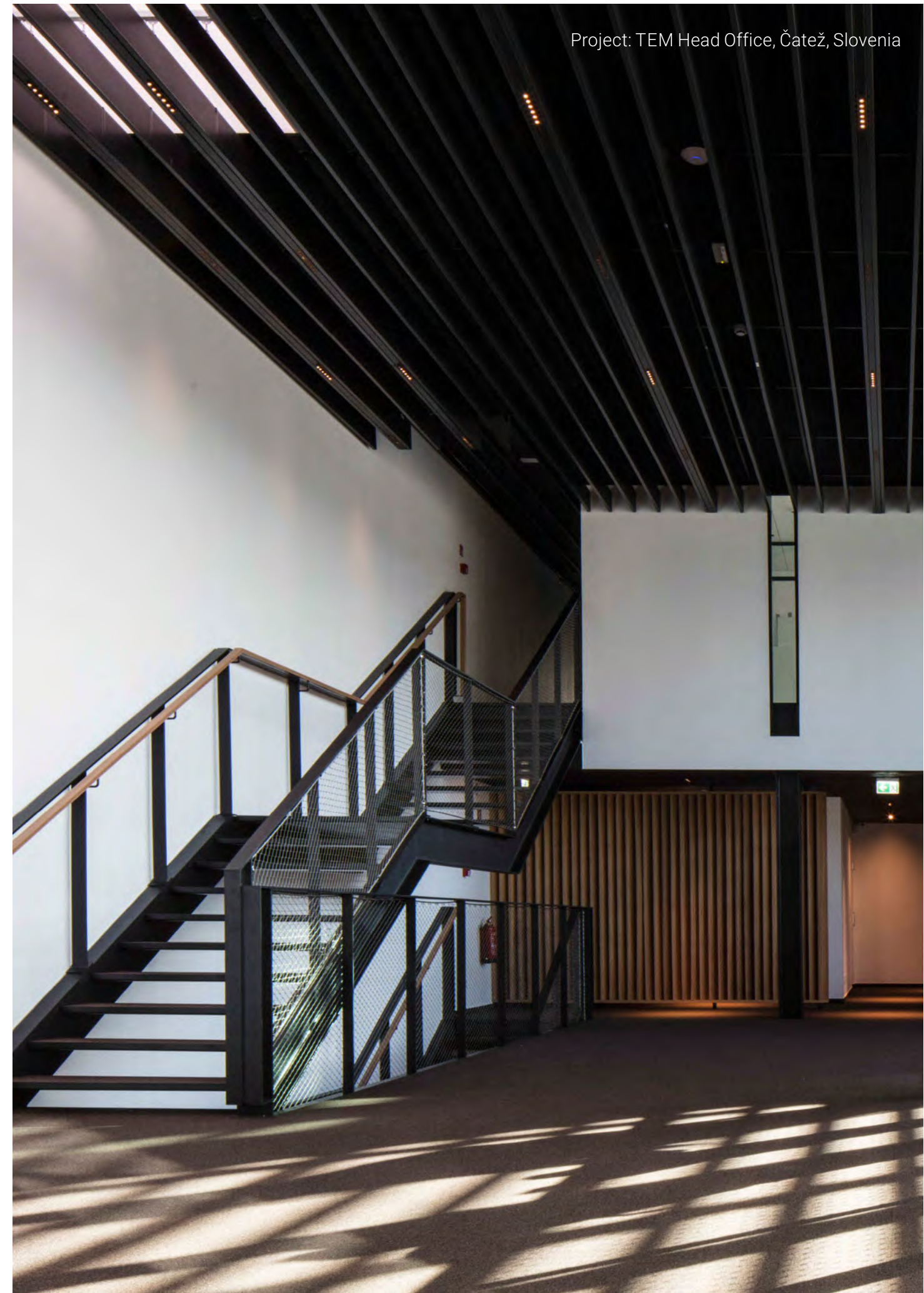

FUSION Linear System – Linear General Light Profile System

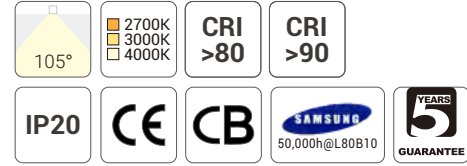

Quick Info

- Linear General Light Profile System
- SAMSUNG LED: 22W, 32W, 48W, CRI>80, CRI>90,
- CCT: 2700K, 3000K, 4000K Available as Standard
- Beam Angle: 105°
- Lumen Output: Up to 5500lm System Luminous Flux
- Mounting Type: Pendant, Surface mounted, Trimless Recessed, Trim Recessed
- LED Driver: ON-OFF, Phase Dim, 1-10V Dim, DALI Dim

Light Distribution

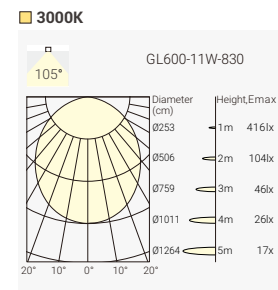
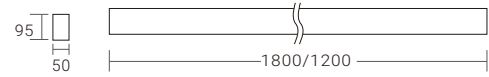

Order Info (in Black Housing as an Example)

LED Power	System Power	LED Voltage	LED Current	CRI	CCT	Beam	LED Output	System Output	Length	Code
32W	36W	46V	700mA	80	2700K	105°	4600lm	3400lm	1800mm	FL1800(X)-GL1800-36W-827A1F-BN
					3000K	105°	4800lm	3600lm	1800mm	FL1800(X)-GL1800-36W-830A1F-BN
					4000K	105°	5000lm	3800lm	1800mm	FL1800(X)-GL1800-36W-840A1F-BN
48W	52W	46V	700+350mA	80	2700K	105°	6200lm	5000lm	1800mm	FL1800(X)-GL1800-52W-827A1F-BN
					3000K	105°	6400lm	5200lm	1800mm	FL1800(X)-GL1800-52W-830A1F-BN
					4000K	105°	7000lm	5500lm	1800mm	FL1800(X)-GL1800-52W-840A1F-BN
22W	26W	46V	500mA	80	2700K	105°	3200lm	2300lm	1200mm	FL1200(X)-GL1200-26W-827A1F-BN
					3000K	105°	3400lm	2700lm	1200mm	FL1200(X)-GL1200-26W-830A1F-BN
					4000K	105°	3600lm	2900lm	1200mm	FL1200(X)-GL1200-26W-840A1F-BN
32W	36W	46V	700mA	80	2700K	105°	4200lm	3400lm	1200mm	FL1200(X)-GL1200-36W-827A1F-BN
					3000K	105°	4400lm	3600lm	1200mm	FL1200(X)-GL1200-36W-830A1F-BN
					4000K	105°	4800lm	3800lm	1200mm	FL1200(X)-GL1200-36W-840A1F-BN

Code Remark: (X)=P (Pendant) (X)=S (Surface mounted) (X)=T (Trimless Recessed) (X)=F (Trim Recessed)
 Code Remark: F=F (ON-OFF) P=P (Phase Dim) A=A (1-10V Dim) D=D (DALI Dim)

Project: Catalina Bay, New Zealand

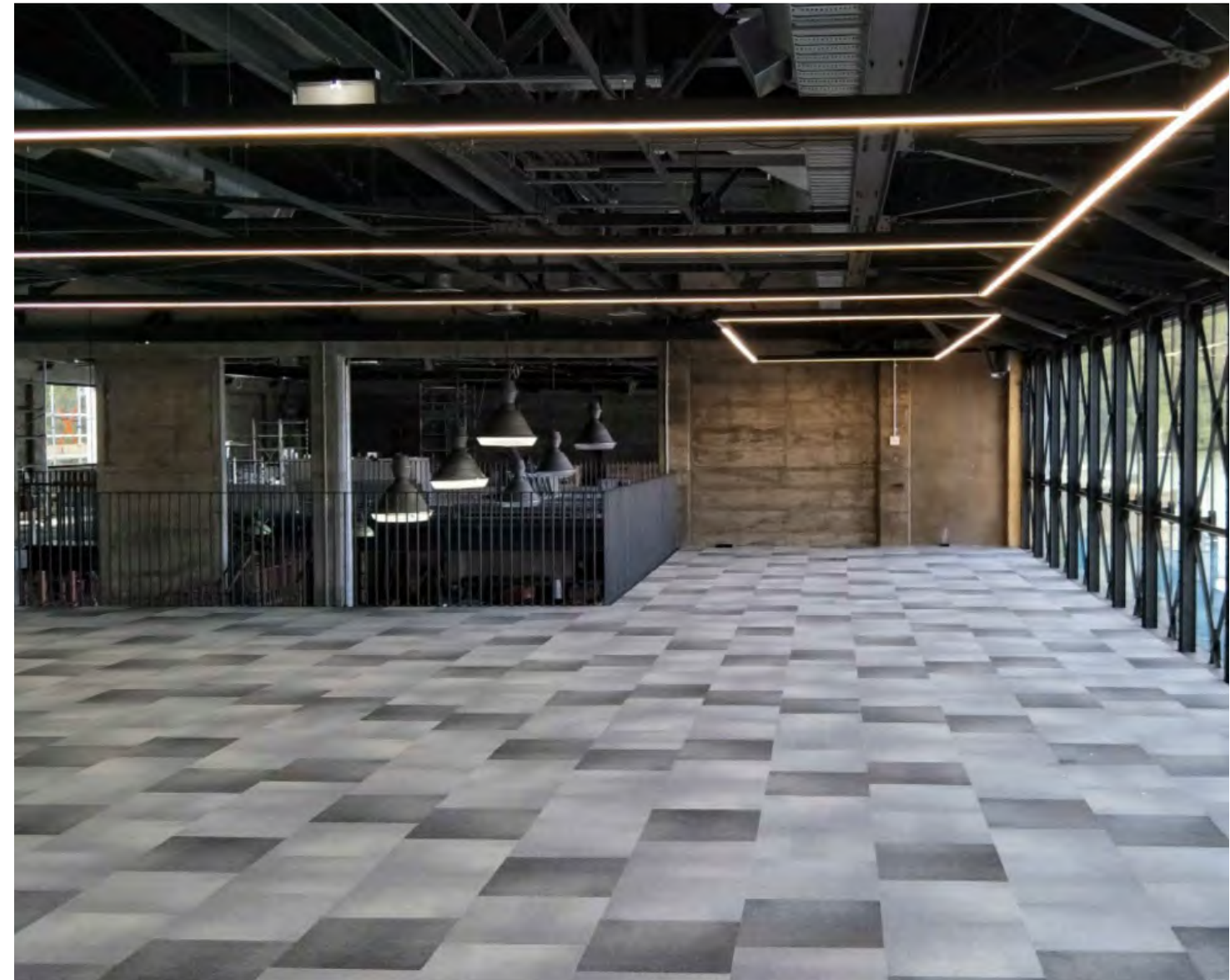

FUSION Linear System – Linear Wall Washer Light Profile System



Quick Info

- Linear Wall Washer Light Profile System
- SAMSUNG LED: 22W, 32W, 48W, CRI>80, CRI>90
- CCT: 2700K, 3000K, 4000K Available as Standard
- Beam Angle: Wall washer
- Lumen Output: Up to 3700lm System Luminous Flux
- Mounting Type: Pendant, Surface mounted, Trimless Recessed, Trim Recessed
- LED Driver: ON-OFF, Phase Dim, 1-10V Dim, DALI Dim

Light Distribution

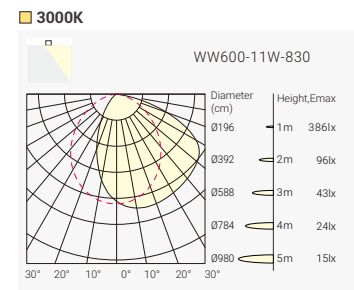

Order Info (in Black Housing as an Example)

LED Power	System Power	LED Voltage	LED Current	CRI	CCT	Beam	LED Output	System Output	Length	Code	
32W	36W	46V	700mA	80	2700K	WW	4600lm	2500lm	1800mm	FL1800(X)-WW1800-36W-827WWF-BN	
						3000K	WW	4800lm	2700lm	1800mm	FL1800(X)-WW1800-36W-830WWF-BN
						4000K	WW	5000lm	2900lm	1800mm	FL1800(X)-WW1800-36W-840WWF-BN
48W	52W	46V	700+350mA	80	2700K	WW	6200lm	3300lm	1800mm	FL1800(X)-WW1800-52W-827WWF-BN	
						3000K	WW	6400lm	3500lm	1800mm	FL1800(X)-WW1800-52W-830WWF-BN
						4000K	WW	6600lm	3700lm	1800mm	FL1800(X)-WW1800-52W-840WWF-BN
22W	26W	46V	500mA	80	2700K	WW	3200lm	1700lm	1200mm	FL1200(X)-WW1200-26W-827WWF-BN	
						3000K	WW	3400lm	1800lm	1200mm	FL1200(X)-WW1200-26W-830WWF-BN
						4000K	WW	3600lm	1900lm	1200mm	FL1200(X)-WW1200-26W-840WWF-BN
32W	36W	46V	700mA	80	2700K	WW	4200lm	2300lm	1200mm	FL1200(X)-WW1200-36W-827WWF-BN	
						3000K	WW	4400lm	2500lm	1200mm	FL1200(X)-WW1200-36W-830WWF-BN
						4000K	WW	5000lm	2700lm	1200mm	FL1200(X)-WW1200-36W-840WWF-BN

Code Remark: (X)=P (Pendant) (X)=S (Surface mounted) (X)=T (Trimless Recessed) (X)=F (Trim Recessed)
Code Remark: F=F(ON-OFF) P=P(Phase Dim) A=A(1-10V Dim) D=D(DALI Dim)

Project: School, Uruguay



FUSION Linear System – Linear Accent Light Profile System

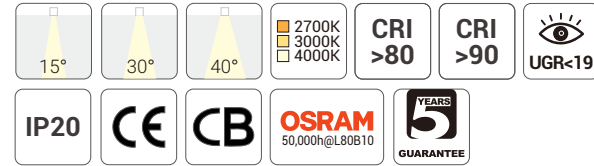

Quick Info

- Linear Accent Light Profile System
- OSRAM LED: 26W, CRI>80, CRI>90
- CCT: 2700K, 3000K, 4000K Available as Standard
- Beam Angle: 15°, 30°, 40°
- Lumen Output: Up to 2600lm System Luminous Flux
- Mounting Type: Pendant, Surface mounted, Trimless Recessed, Trim Recessed
- LED Driver: ON-OFF, Phase Dim, 1-10V Dim, DALI Dim

Light Distribution

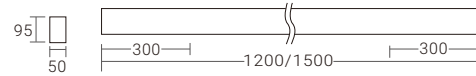

3000K

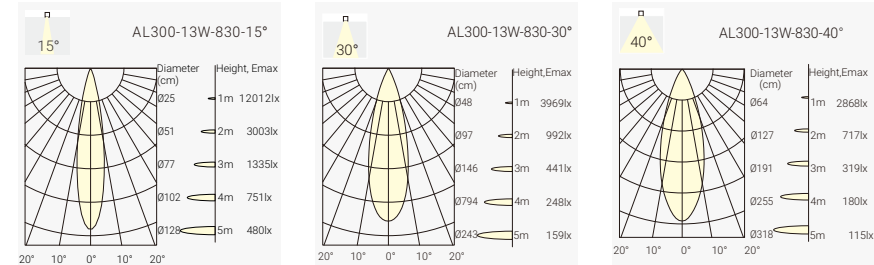

Order Info (in Black Housing as an Example)

LED Power	System Power	LED Voltage	LED Current	CRI	CCT	Beam	LED Output	System Output	Length	Code						
26W	30W	36V	700mA	80	2700K	15°	2800lm	2000lm	1200mm	FL1200(X)-2*AL300-30W-82715F-BB						
						30°	2800lm	2000lm	1200mm	FL1200(X)-2*AL300-30W-82730F-BB						
						40°	2800lm	2200lm	1200mm	FL1200(X)-2*AL300-30W-82740F-BB						
						3000K	15°	3000lm	2200lm	1200mm	FL1200(X)-2*AL300-30W-83015F-BB					
							30°	3000lm	2200lm	1200mm	FL1200(X)-2*AL300-30W-83030F-BB					
							40°	3000lm	2400lm	1200mm	FL1200(X)-2*AL300-30W-83040F-BB					
						4000K	15°	3400lm	2400lm	1200mm	FL1200(X)-2*AL300-30W-84015F-BB					
							30°	3400lm	2400lm	1200mm	FL1200(X)-2*AL300-30W-84030F-BB					
							40°	3400lm	2600lm	1200mm	FL1200(X)-2*AL300-30W-84040F-BB					
						26W	30W	36V	700mA	80	2700K	15°	2800lm	2000lm	1500mm	FL1500(X)-2*AL300-30W-82715F-BB
												30°	2800lm	2000lm	1500mm	FL1500(X)-2*AL300-30W-82730F-BB
												40°	2800lm	2200lm	1500mm	FL1500(X)-2*AL300-30W-82740F-BB
3000K	15°	3000lm	2200lm	1500mm	FL1500(X)-2*AL300-30W-83015F-BB											
	30°	3000lm	2200lm	1500mm	FL1500(X)-2*AL300-30W-83030F-BB											
	40°	3000lm	2400lm	1500mm	FL1500(X)-2*AL300-30W-83040F-BB											
4000K	15°	3400lm	2400lm	1500mm	FL1500(X)-2*AL300-30W-84015F-BB											
	30°	3400lm	2400lm	1500mm	FL1500(X)-2*AL300-30W-84030F-BB											
	40°	3400lm	2600lm	1500mm	FL1500(X)-2*AL300-30W-84040F-BB											

Code Remark: (X)=P (Pendant) (X)=S (Surface mounted) (X)=T (Trimless Recessed) (X)=F (Trim Recessed)
Code Remark: F=F (ON-OFF) P=P (Phase Dim) A=A (1-10V Dim) D=D (DALI Dim)

Project: Skyline Hill, Germany



FUSION Linear System – Linear General Light & Accent Light Profile System

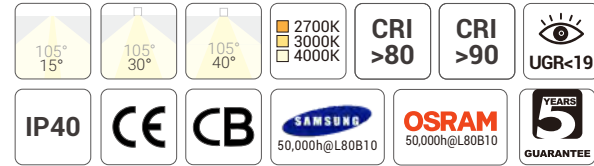

Quick Info

- Linear General Light & Accent Light Profile System
- SAMSUNG LED, OSRAM LED: 37W, CRI>80, CRI>90
- CCT: 2700K, 3000K, 4000K Available as Standard
- Beam Angle: 15°+105°, 30°+105°, 40°+105°
- Lumen Output: Up to 3300lm-4000lm System Luminous Flux
- Mounting Type: Pendant, Surface mounted, Trimless Recessed, Trim Recessed
- LED Driver: ON-OFF, Phase Dim, 1-10V Dim, DALI Dim

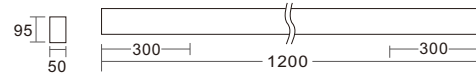

Light Distribution

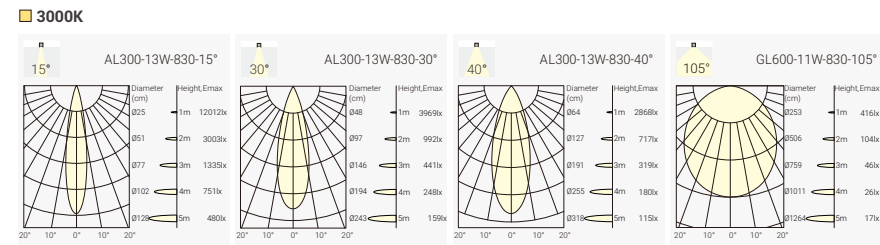

Order Info (in Black Housing as an Example)

LED Power	System Power	LED Voltage	LED Current	CRI	CCT	Beam	LED Output	System Output	Code
37W	41W	47V	700mA	80	2700K	15°+105°	4500lm	3300lm	FL1200(X)2*AL300+GL600-41W-82715F-BB
						30°+105°	4500lm	3300lm	FL1200(X)2*AL300+GL600-41W-82730F-BB
						40°+105°	4500lm	3500lm	FL1200(X)2*AL300+GL600-41W-82740F-BB
					3000K	15°+105°	4700lm	3500lm	FL1200(X)2*AL300+GL600-41W-83015F-BB
						30°+105°	4700lm	3500lm	FL1200(X)2*AL300+GL600-41W-83030F-BB
						40°+105°	4700lm	3700lm	FL1200(X)2*AL300+GL600-41W-83040F-BB
					4000K	15°+105°	5100lm	3800lm	FL1200(X)2*AL300+GL600-41W-84015F-BB
						30°+105°	5100lm	3800lm	FL1200(X)2*AL300+GL600-41W-84030F-BB
						40°+105°	5100lm	4000lm	FL1200(X)2*AL300+GL600-41W-84040F-BB

Code Remark: (X)=P (Pendant) (X)=S (Surface mounted) (X)=T (Trimless Recessed) (X)=F (Trim Recessed)
 Code Remark: N=N (No Driver) F=F (ON-OFF) P=P (Phase Dim) A=A (1-10V Dim) D=D (DALI Dim)

Project: Office Shire House, U.K.



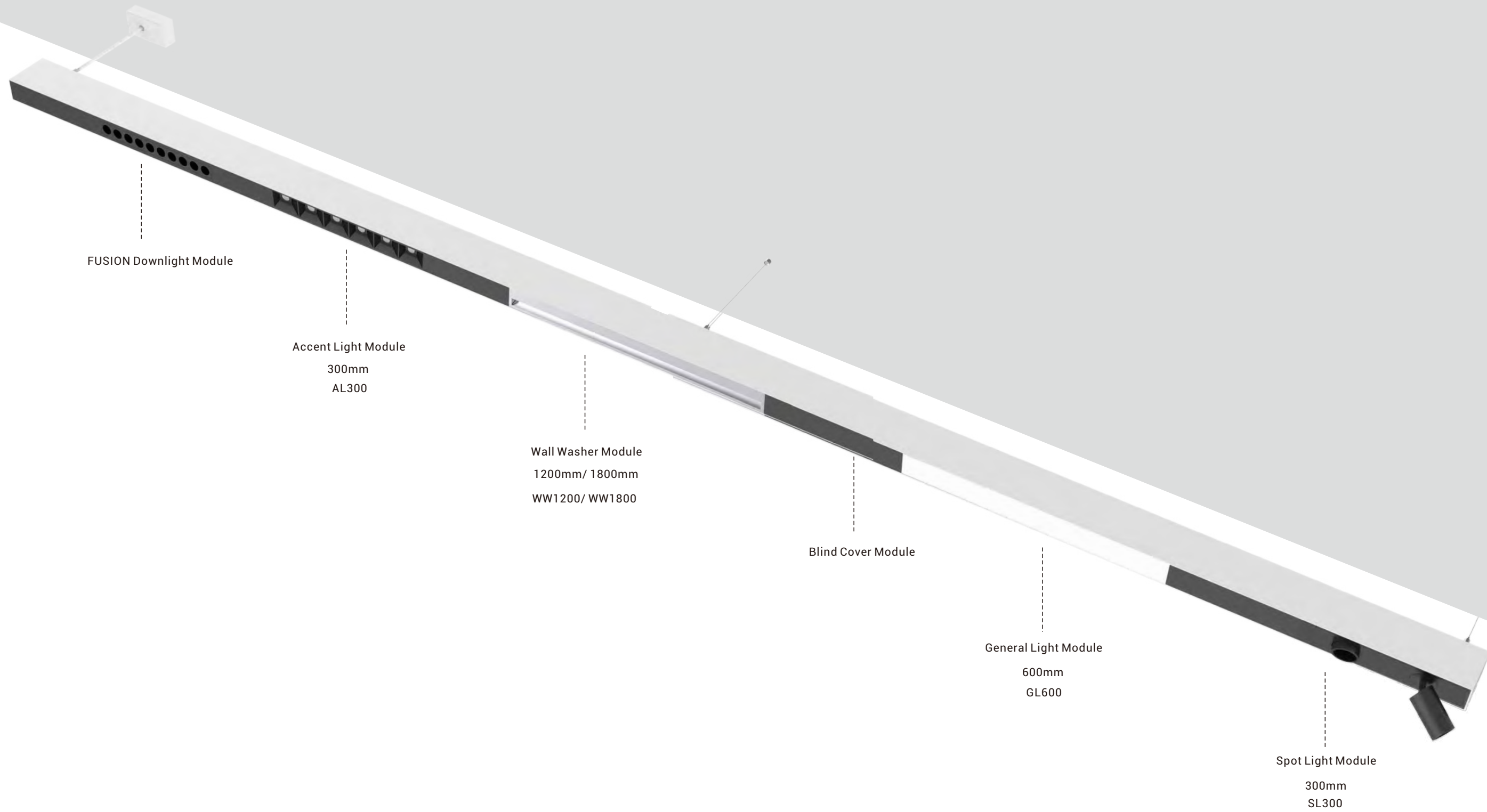

Linear System with more modules combination available.
All available with Suspended, surface mounted and recessed mounted versions.

SPACE 60

Ideal Profile System
for Office Lighting
Profile-based Basic Lighting

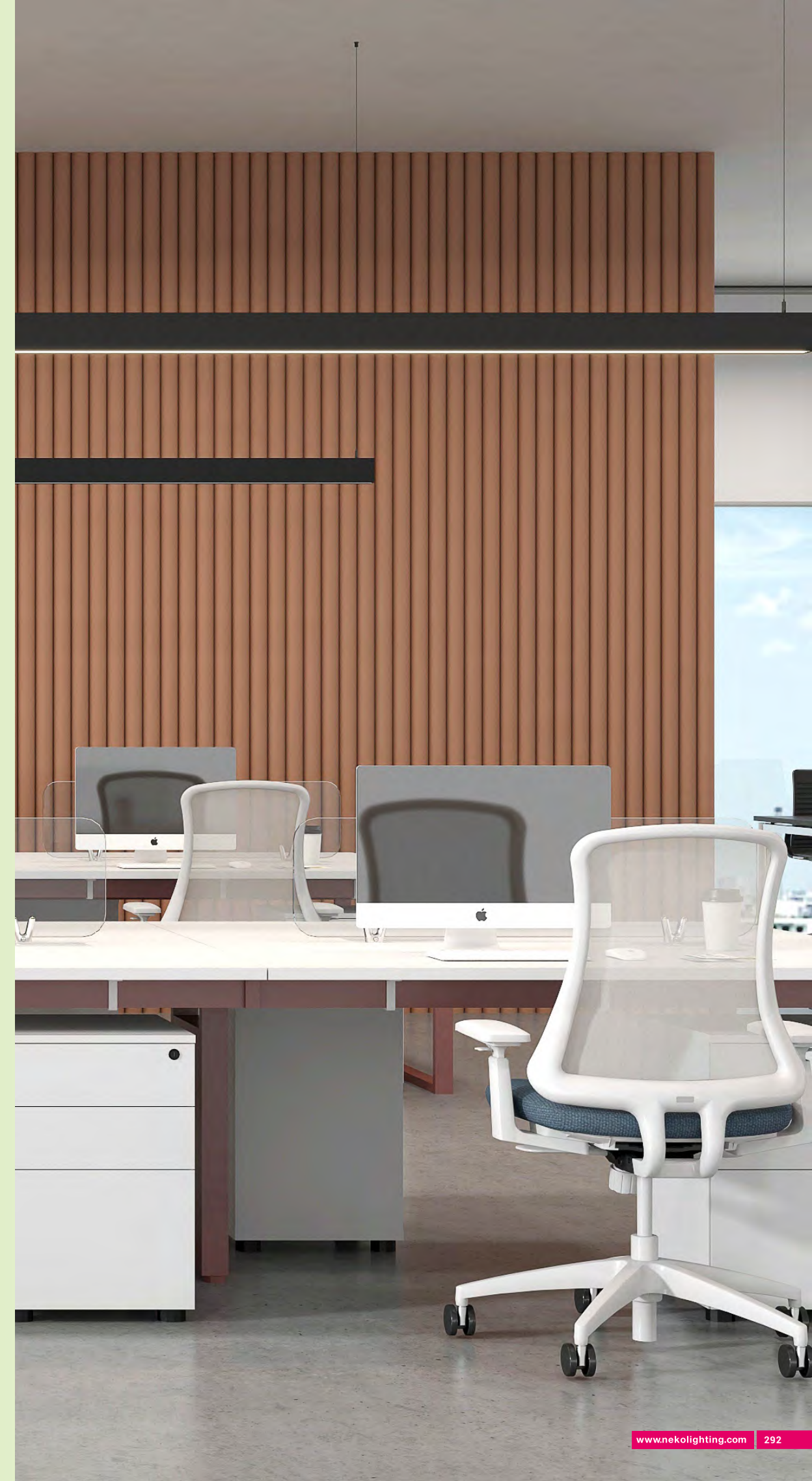

SPACE 60 – Linear Profile System

SPACE 60 is an ideal profile system for any office lighting project, thanks to its wide range of configuration options. The profile is specially made with a 65mm width to ensure strict glare control (UGR<19) and homogeneous lighting. Available profile lengths include 614mm, 914mm, 1214mm, 1514mm, and 1814mm, which can be used individually or connected continuously to meet different spatial needs. Combined with L-shaped, T-shaped, and X-shaped modules, SPACE 60 opens up more possibilities for optimal integration in every project.

LENGTHS:

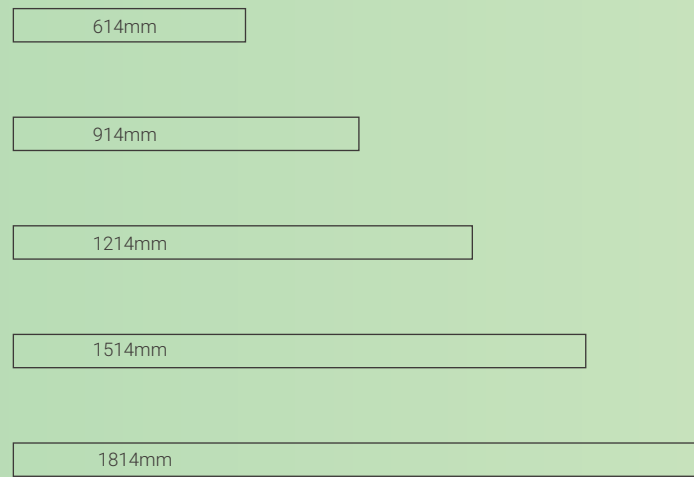

MOUNTINGS:

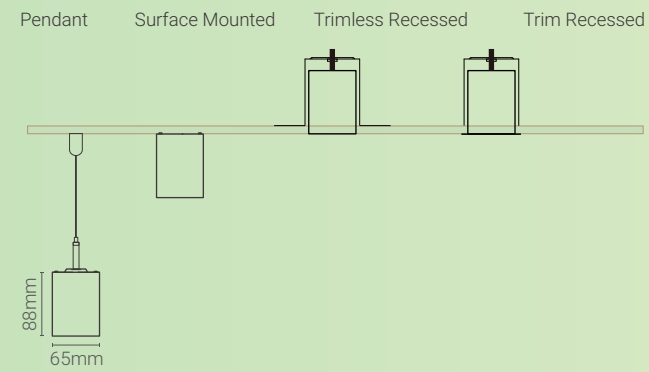

CORNER MODULES:

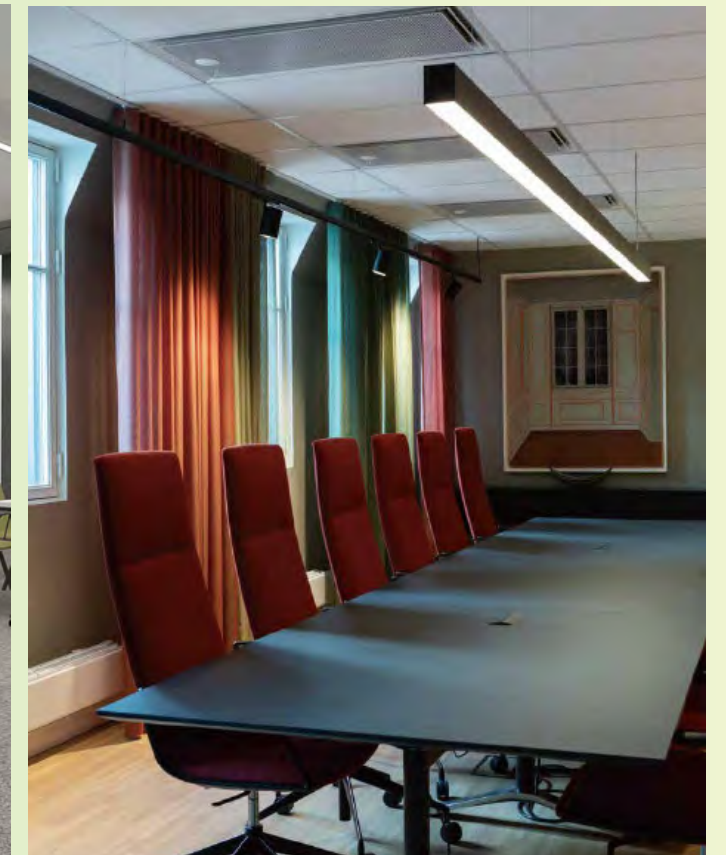
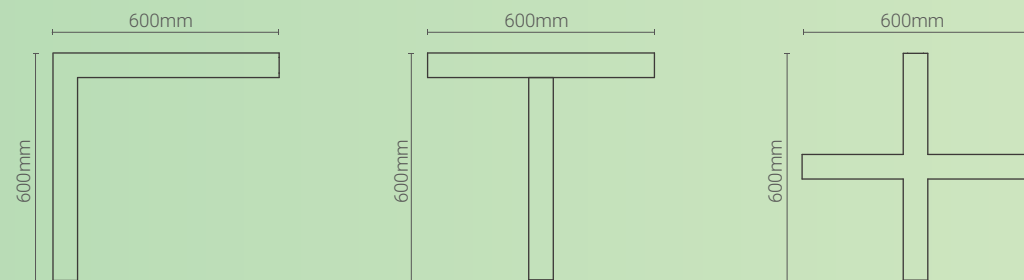

SPACE 60 – Linear Profile System

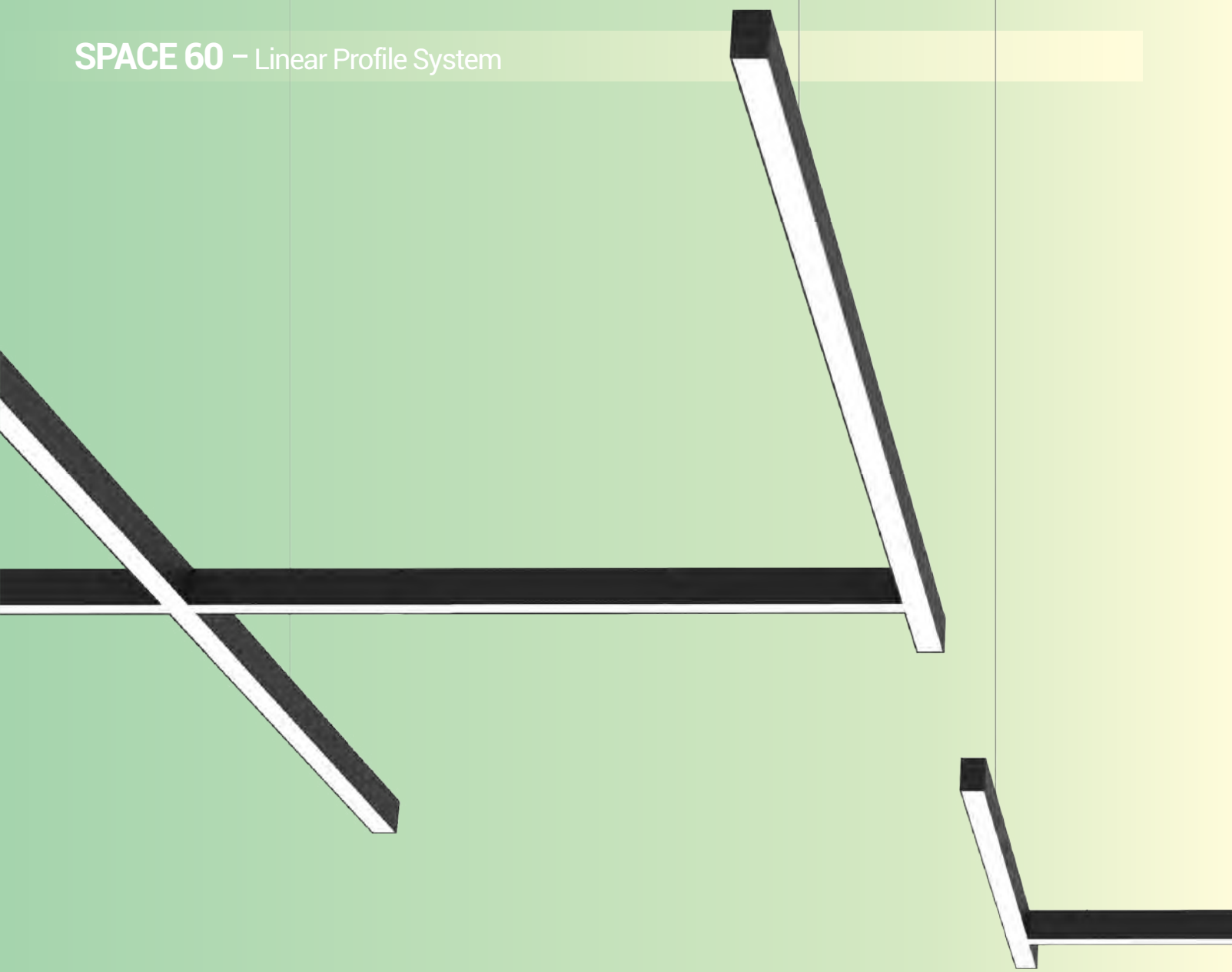

SPACE 60 standard version features a microprismatic cover to enhance visual comfort (UGR<19) combined with homogeneous lighting. Opal cover version is available as an option, offering even lighting and a wider beam angle (UGR<22).

Besides its elegant appearance, its detail-oriented design makes it favored by designers, electricians and users. All the profile connection joints and profile end caps (NO visible screw) are designed with anti-leakage measures, ensuring optimal & clean light performance. All profiles are equipped with quick-connectors, allowing for fast, easy installation and maintenance.

Mounting options include pendant direct, pendant direct & indirect, surface-mounted, trimless recessed & trim recessed. The LED driver, available in either ON-OFF or DALI Dim, is integrated into the light channel. Other dimming LED drivers are also available on demand.

It's elegant appearance and detail-oriented design make SPACE 60 an ideal profile system for office lighting or any profile-based basic lighting



Product Features



Microprismatic cover for visual comfort (UGR<19)

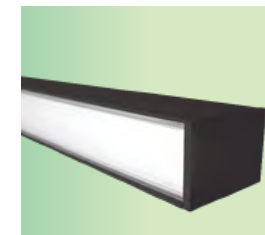

No visible screw



Perfect joints, no light gaps

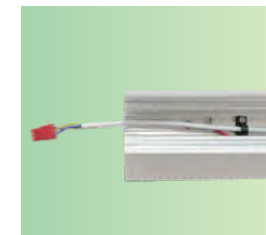

Quick-connector for fast connection



Twist-lock design light module, easy installation & maintenance

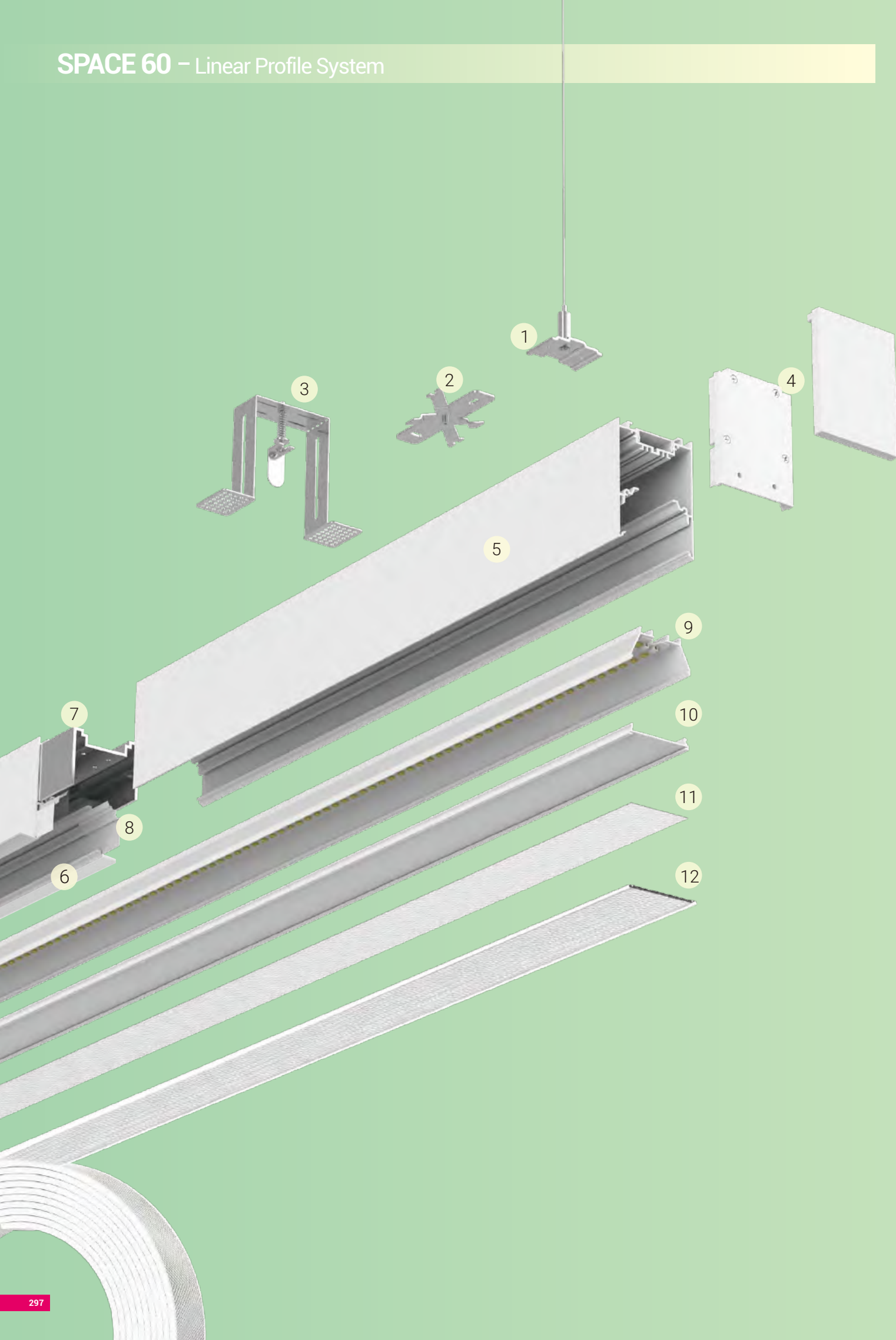

Construction

- 1 Pendant Installation Steel Wire Kit
- 2 Surface Mounted Installation Brackets
- 3 Trimless Recessed Installation Brackets
- 4 End Cap Set (no light leakage, no visible screw)
- 5 Profile Channel without Trim
- 6 Profile Channel with Trim
- 7 Linear Connector
- 8 Light Leakage Prevention Cover
- 9 LED Module
- 10 Opal Diffuser Cover
- 11 Microprismatic Film
- 12 Flexible Microprismatic Cover (UGR<19)/ Flexible Opal Diffuser
30 meters per run, in-field cuttable



UGR<19

SPACE 60 Linear System

- The profile is specially made with a 65mm width together with clever triple-layer optical design to ensure strict glare control (UGR<19), homogeneous lighting and efficiency.
 - High quality surface treatment
 - The end cap is no visible screw
- Quick-connector allows fast connection

Visual comfort



UGR<19

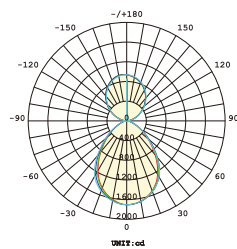

Photometric curves of SPACE 60 P-CL1500U-47W-840-80° ↑ 105° ↓



Product: SPACE 60 P-CL1500U-47W-840-80° ↑ 105° ↓
 Worktop dimensions: (L x W x H) 1800 x 900 x 800 mm
 Ceiling height: 3000 mm
 Lamp height from worktop: 1300 mm
 Average illuminance: 535 lx
 Uniformity: 0.64 UGR: <19



SPACE 60 – Linear Profile System

Project: Nardo Bil Ålesund, Norway



Project: Janashakthi Group's corporate office, Sri Lanka



SPACE 60 – Pendant Direct & Indirect

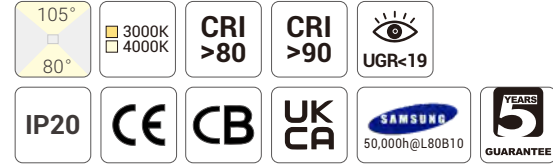

Quick Info

- General Lighting, Pendant Direct & Indirect
- SAMSUNG LED: 21W, 31W, 38W, 47W, 56W; CRI>80, CRI>90
- CCT: 3000K, 4000K Available as Standard
- Beam Angle: 80° ↓ 105° ↑
- Lumen Output: Up to 6400lm System Luminous Flux
- LED Driver: ON-OFF, 1-10V Dim, DALI Dim

Light Distribution

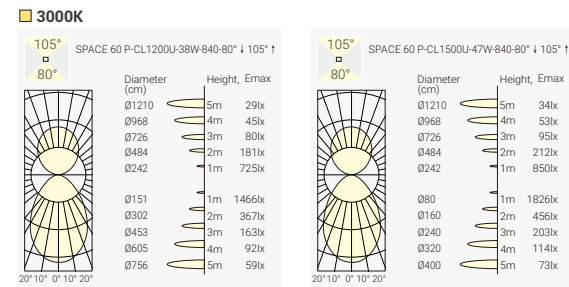
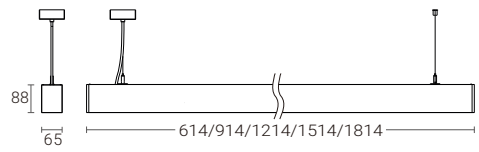

Order Info

LED Power	System Power	LED Voltage	LED Current	Length	Color	CRI	CCT	Beam	System Output	Code
19W	21W	33V	600mA	614mm	White	80	4000K	80° ↓ 105° ↑	1250lm ↓ 950lm ↑	SE6M-8408021F-WN-U
29W	31W	33V	900mA	914mm	White	80	4000K	80° ↓ 105° ↑	2050lm ↓ 1150lm ↑	SE9M-8408031F-WN-U
35W	38W	33V	1050mA	1214mm	White	80	4000K	80° ↓ 105° ↑	2500lm ↓ 1700lm ↑	SEAP-8408038F-WN-U
43W	47W	33V	1300mA	1514mm	White	80	4000K	80° ↓ 105° ↑	3300lm ↓ 2300lm ↑	SEBP-8408047F-WN-U
52W	56W	33V	1600mA	1814mm	White	80	4000K	80° ↓ 105° ↑	3800lm ↓ 2600lm ↑	SECP-8408056F-WN-U

Code Remark: F=F(ON-OFF) A=A(1-10V Dim) D=D(DALI Dim)

Coding

Model	CRI/ CCT	Beam Angle	Power	Control	Finish	Reflector Color	Accessory
SE6M 600mm Module	830 CRI80/ 3000K	80 80° ↓	21 21W	F On-Off	w White	N None	U Uplight
SE9M 900mm Module	840 CRI80/ 4000K	80 80° ↓ 105° ↑	31 21W	A 1-10V Dim	B Black		
SEAP Pendant 1200mm	930 CRI90/ 3000K		38 38W	D DALI Dim			
SEBP Pendant 1500mm	940 CRI90/ 4000K		47 47W				
SECP Pendant 1800mm			56 56W				



Project: Application Reference

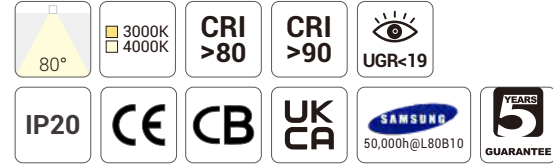

Quick Info

- General Light Version also Available
- SAMSUNG LED: 13W, 21W, 26W, 34W, 39W,
- CCT: 3000K, 4000K Available as Standard
- Beam Angle: 80° ↓
- Lumen Output: Up to 3900lm System Luminous Flux
- LED Driver: ON-OFF, 1-10V Dim, DALI Dim

Light Distribution

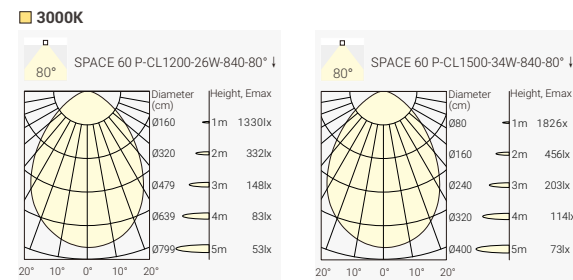
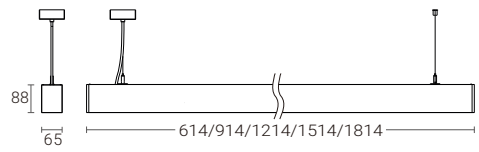

Order Info

LED Power	System Power	LED Voltage	LED Current	Length	Color	CRI	CCT	Beam	System Output	Code
11W	13W	33V	350mA	614mm	White	80	4000K	80° ↓	1250lm	SE6M-8408013F-WN
19W	21W	33V	600mA	914mm	White	80	4000K	80° ↓	2050lm	SE9M-8408021F-WN
23W	26W	33V	700mA	1214mm	White	80	4000K	80° ↓	2600lm	SEAP-8408026F-WN
30W	34W	33V	900mA	1514mm	White	80	4000K	80° ↓	3400lm	SEBP-8408034F-WN
35W	39W	33V	1050mA	1814mm	White	80	4000K	80° ↓	3900lm	SECP-8408039F-WN

Code Remark: F=F(ON-OFF) A=A(1-10V Dim) D=D(DALI Dim)

Coding

Model	CRI/ CCT	Beam Angle	Power	Control	Finish	Reflector Color	Accessory
SE6M 600mm Module	830 CRI80/ 3000K	80 80° ↓	13 13W	F On-Off	w White	N None	
SE9M 900mm Module	840 CRI80/ 4000K		21 21W	A 1-10V Dim	B Black		
SEAP Pendant 1200mm	930 CRI90/ 3000K		26 26W	D DALI Dim			
SEBP Pendant 1500mm	940 CRI90/ 4000K		34 34W				
SECP Pendant 1800mm			39 39W				



Project: JBF KONTOR, OSLO, Norway

SPACE 60 – Surface Mounted

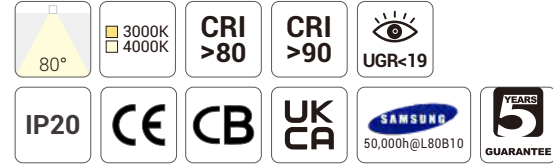

Quick Info

- General Light Version also Available
- SAMSUNG LED: 13W, 21W, 26W, 34W, 39W,
- CCT: 3000K, 4000K Available as Standard
- Beam Angle: 80° ↓
- Lumen Output: Up to 3900lm System Luminous Flux
- LED Driver: ON-OFF, 1-10V Dim, DALI Dim

Light Distribution

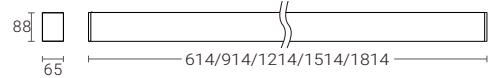

3000K

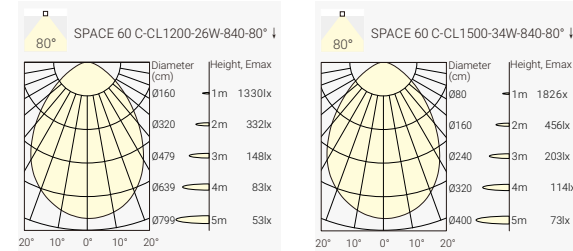

Order Info

LED Power	System Power	LED Voltage	LED Current	Length	Color	CRI	CCT	Beam	System Output	Code
11W	13W	33V	350mA	614mm	White	80	4000K	80° ↓	1250lm	SE6M-8408013F-WN
19W	21W	33V	600mA	914mm	White	80	4000K	80° ↓	2050lm	SE9M-8408021F-WN
23W	26W	33V	700mA	1214mm	White	80	4000K	80° ↓	2600lm	SEAC-8408026F-WN
30W	34W	33V	900mA	1514mm	White	80	4000K	80° ↓	3400lm	SEBC-8408034F-WN
35W	39W	33V	1050mA	1814mm	White	80	4000K	80° ↓	3900lm	SECC-8408039F-WN

Code Remark: F=F(ON-OFF) A=A(1-10V Dim) D=D(DALI Dim)

Coding

Model	CRI/ CCT	Beam Angle	Power	Control	Finish	Reflector Color	Accessory
SE6M 600mm Module	830 CRI80/ 3000K	80 80° ↓	13 13W	F On-Off	w White	N None	
SE9M 900mm Module	840 CRI80/ 4000K		21 21W	A 1-10V Dim	B Black		
SEAC Surface Mounted 1200mm	930 CRI90/ 3000K		26 26W	D DALI Dim			
SEBC Surface Mounted 1500mm	940 CRI90/ 4000K		34 34W				
SECC Surface Mounted 1800mm			39 39W				

Project: Nardo Bil Ålesund, Norway

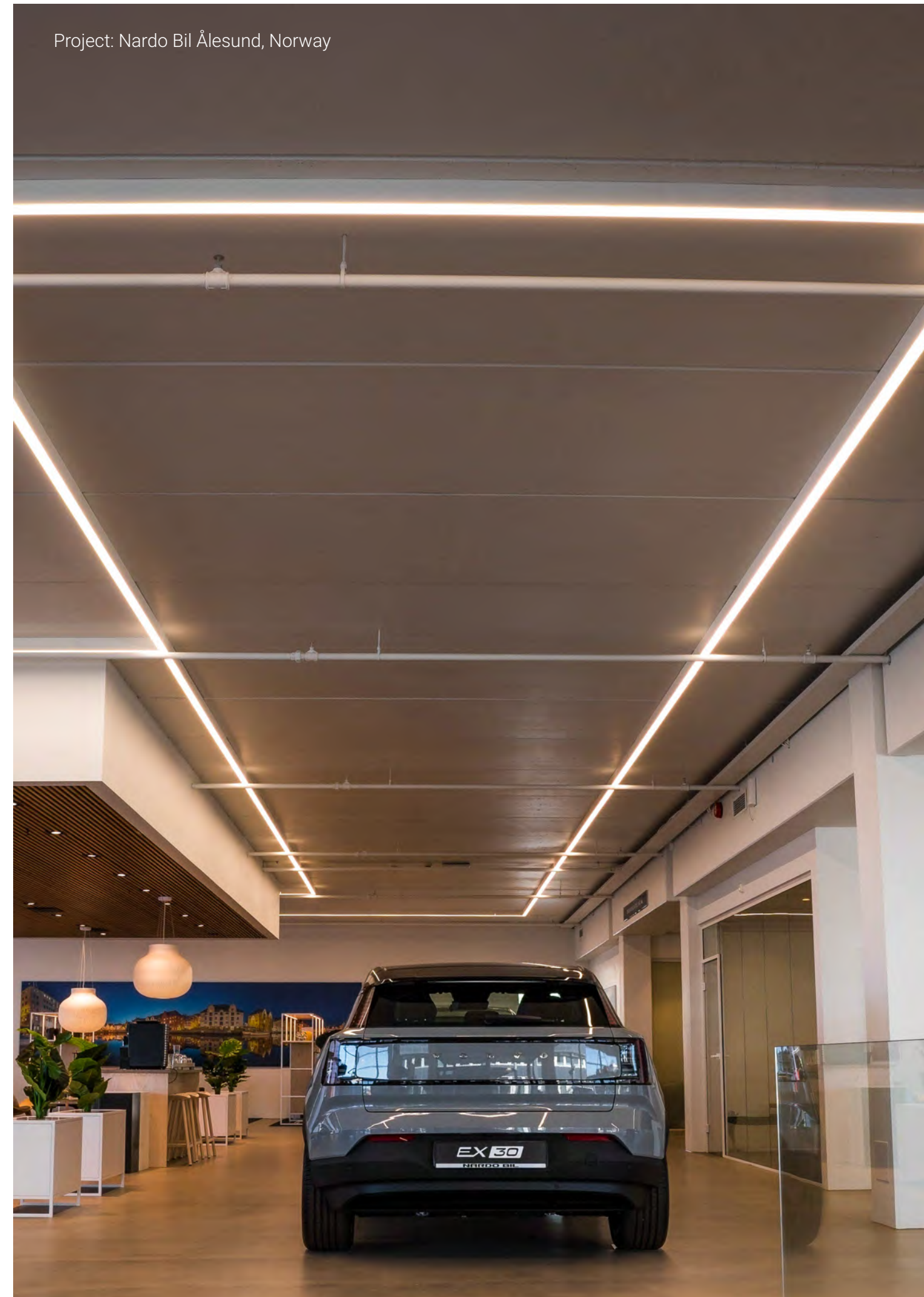

SPACE 60 – Trim Recessed

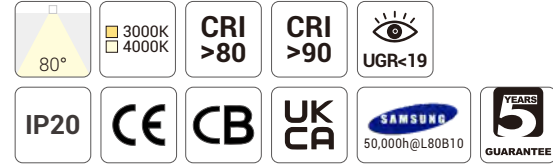
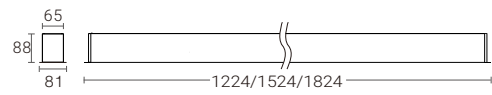

Quick Info

- General Light Version also Available
- SAMSUNG LED: 13W, 21W, 26W, 34W, 39W,
- CCT: 3000K, 4000K Available as Standard
- Beam Angle: 80° ↓
- Lumen Output: Up to 3900lm System Luminous Flux
- LED Driver: ON-OFF, 1-10V Dim, DALI Dim

Light Distribution

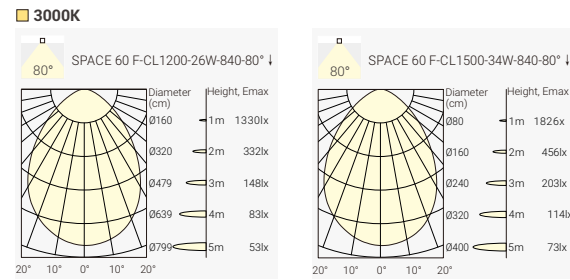

Order Info

LED Power	System Power	LED Voltage	LED Current	Length	Color	CRI	CCT	Beam	System Output	Code
11W	13W	33V	350mA	614mm	White	80	4000K	80° ↓	1250lm	SE6F-8408013F-WN
19W	21W	33V	600mA	914mm	White	80	4000K	80° ↓	2050lm	SE9F-8408021F-WN
23W	26W	33V	700mA	1214mm	White	80	4000K	80° ↓	2600lm	SEAF-8408026F-WN
30W	34W	33V	900mA	1514mm	White	80	4000K	80° ↓	3400lm	SEBF-8408034F-WN
35W	39W	33V	1050mA	1814mm	White	80	4000K	80° ↓	3900lm	SECF-8408039F-WN

Code Remark: F=F(ON-OFF) A=A(1-10V Dim) D=D(DALI Dim)

Coding

Model	CRI/ CCT	Beam Angle	Power	Control	Finish	Reflector Color	Accessory
SE6F	830	80	13	F	w	N	
Trim Recessed 600mm	CR180/ 3000K	80° ↓	13W	On-Off	White	None	
SE9F	840		21	A	B		
Trim Recessed 900mm	CR180/ 4000K		21W	1-10V Dim	Black		
SEAF	930		26	D			
Trim Recessed 1200mm	CR190/ 3000K		26W	DALI Dim			
SEBF	940		34				
Trim Recessed 1500mm	CR190/ 4000K		34W				
SECF			39				
Trim Recessed 1800mm			39W				

SPACE 60 – Trimless Recessed

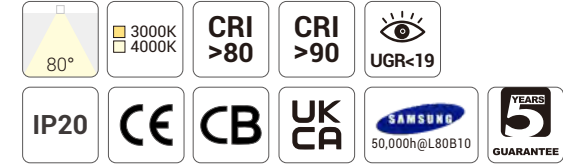
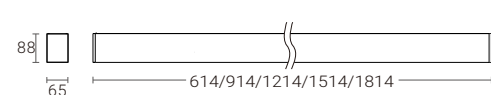
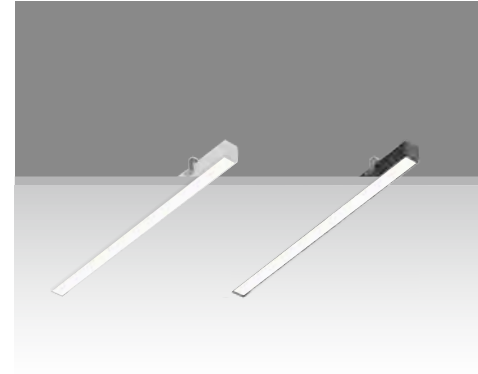

Quick Info

- General Light Version also Available
- SAMSUNG LED: 13W, 21W, 26W, 34W, 39W,
- CCT: 3000K, 4000K Available as Standard
- Beam Angle: 80° ↓
- Lumen Output: Up to 3900lm System Luminous Flux
- LED Driver: ON-OFF, 1-10V Dim, DALI Dim

Light Distribution

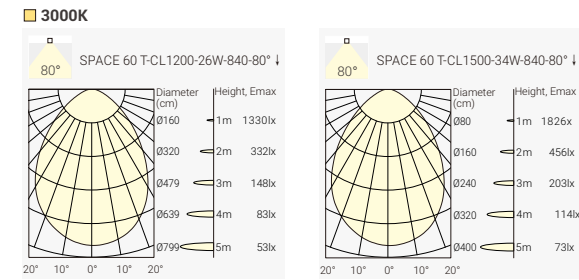

Order Info

LED Power	System Power	LED Voltage	LED Current	Length	Color	CRI	CCT	Beam	System Output	Code
11W	13W	33V	350mA	614mm	White	80	4000K	80° ↓	1250lm	SE6M-8408013F-WN
19W	21W	33V	600mA	914mm	White	80	4000K	80° ↓	2050lm	SE9M-8408021F-WN
23W	26W	33V	700mA	1214mm	White	80	4000K	80° ↓	2600lm	SEAT-8408026F-WN
30W	34W	33V	900mA	1514mm	White	80	4000K	80° ↓	3400lm	SEBT-8408034F-WN
35W	39W	33V	1050mA	1814mm	White	80	4000K	80° ↓	3900lm	SECT-8408039F-WN

Code Remark: F=F(ON-OFF) A=A(1-10V Dim) D=D(DALI Dim)

Coding

Model	CRI/ CCT	Beam Angle	Power	Control	Finish	Reflector Color	Accessory
SE6M	830	80	13	F	w	N	
600mm Module	CR180/ 3000K	80° ↓	13W	On-Off	White	None	
SE9M	840		21	A	B		
900mm Module	CR180/ 4000K		21W	1-10V Dim	Black		
SEAT	930		26	D			
Trimless Recessed 1200mm	CR190/ 3000K		26W	DALI Dim			
SEBT	940		34				
Trimless Recessed 1500mm	CR190/ 4000K		34W				
SECT			39				
Trimless Recessed 1800mm			39W				

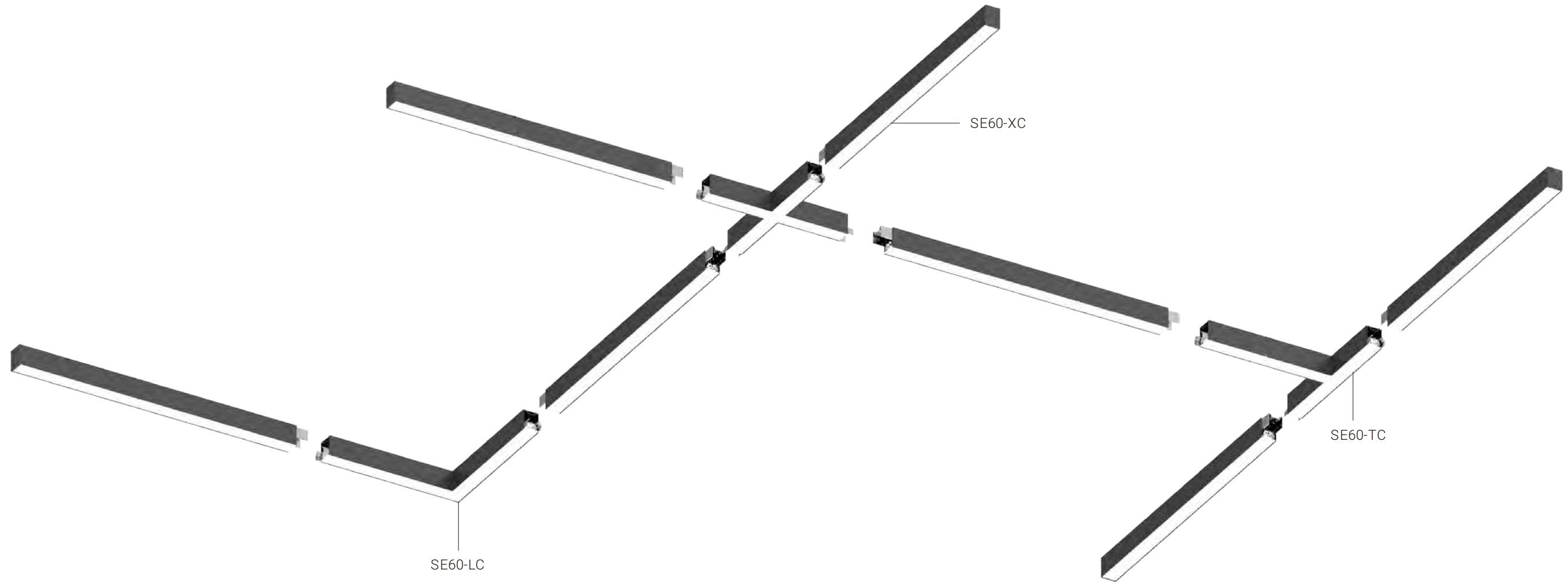

Corner Module of SPACE 60 Linear System

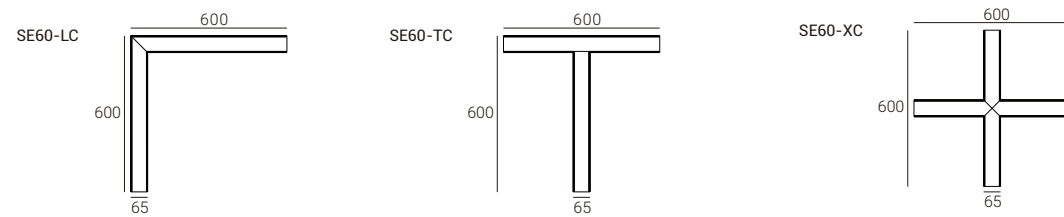

	SE60-PK	Pendnat Installation Kit (with Ceiling Box)
	SE60-PWK	Pendnat Steel Wire Kit (no Ceiling Box)
	SE60-SMK	Surface Mounted Kit
	SE60-TRK	Linear Connector Kit
	SE60-LCK	Trimless Recessed Mounting kit
	SE60-FMPC-30M SE60-FOPC-30M	Flexible Microprismatic Cover, in 30 Meters per Roll Flexible Opal Cover, in 30 Meters per Roll

LED Power	System Power	LED Voltage	LED Current	Length	Color	CRI	CCT	Beam	System Output	Code
23W	26W	33V	700mA	L: 600x600mm	White	80	4000K	80°	2500lm	SELC-8408026F-WN
23W	26W	33V	700mA	T: 600x600mm	White	80	4000K	80°	2500lm	SETC-8408026F-WN
23W	26W	33V	700mA	X: 600x600mm	White	80	4000K	80°	2500lm	SEXC-8308026F-WN

Code Remark: F=F(ON-OFF) A=A(1-10V Dim) D=D(DALI Dim)

Coding

Model	CRI/ CCT	Beam Angle	Power	Control	Finish	Reflector Color	Accessory
SELC SPACE 60 L Corner Module	830 CRI80/ 3000K	80 80°	26 26W	F On-Off	W White	N None	
SELC SPACE 60 L Corner Module	840 CRI80/ 4000K			A 1-10V Dim	B Black		
SELC SPACE 60 L Corner Module	930 CRI90/ 3000K			D DALI Dim			
SELC SPACE 60 L Corner Module	940 CRI90/ 4000K						

MODULINE 05

The ultra-slim 24V modular linear system.

Epitomizing minimalist elegance, boasting an ultra-slim track with a 5mm width aperture.

Its seamless integration into any environment ensures a natural and effortless aesthetic, ideal for residential, retail, or any setting where sleek design reigns supreme.

5.4mm



! NEW



project: Application reference

NEW

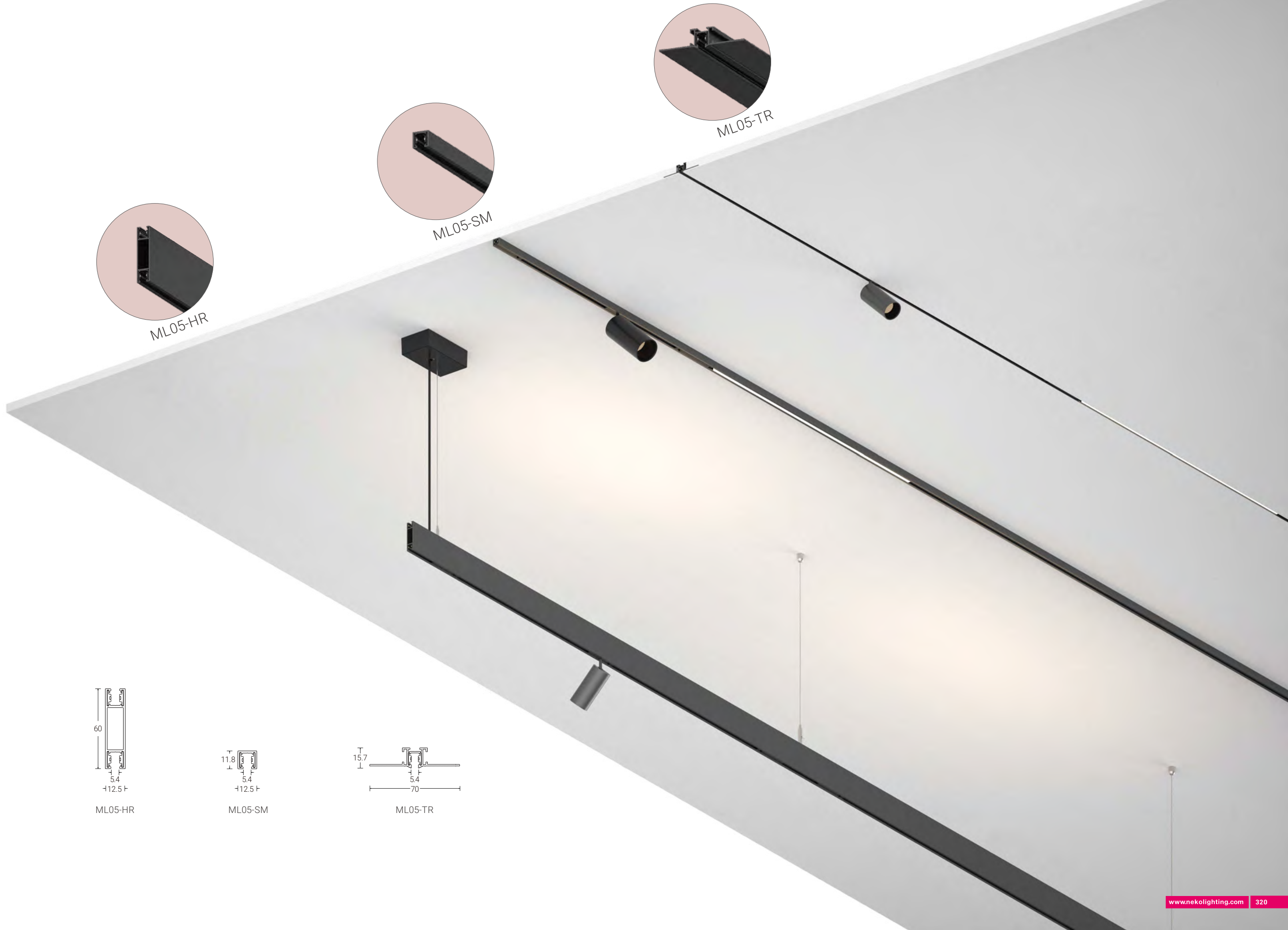

ML05-HR

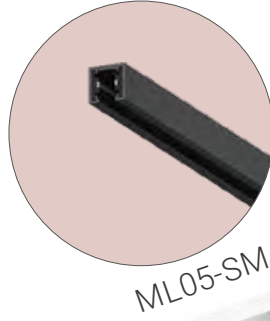

ML05-SM



ML05-TR

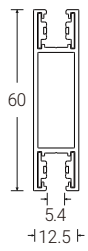

ML05-HR

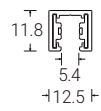

ML05-SM

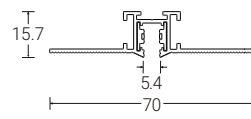

ML05-TR

NEW

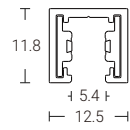

Surface-mounted Track

Order Info

Length	Description	Code/ Model (Black)	Code/ Model (White)
1000mm	Surface Mounted Track Rail	ML05-SM1000-B	ML05-SM1000-W
2000mm	Surface Mounted Track Rail	ML05-SM2000-B	ML05-SM2000-W
3000mm	Surface Mounted Track Rail	ML05-SM3000-B	ML05-SM3000-W

Accessories

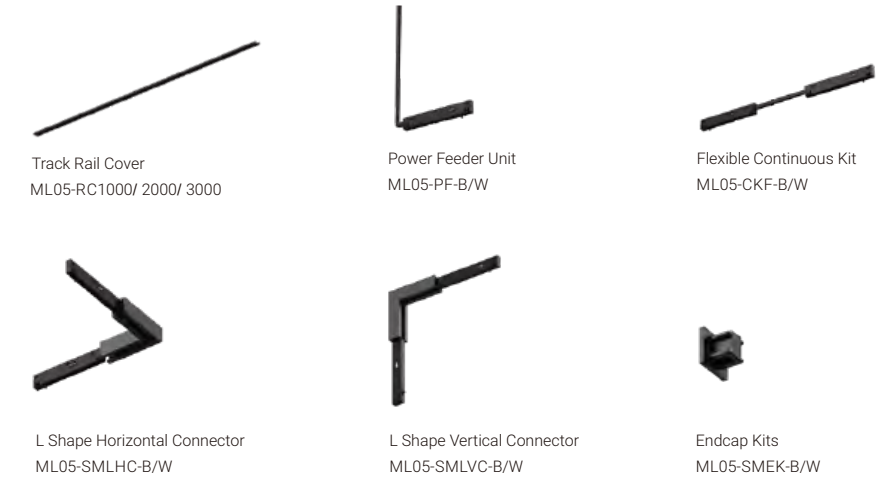

NEW

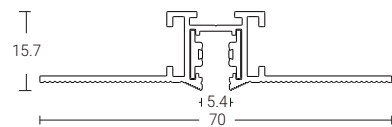

Trimless-recessed Track

Order Info

Length	Description	Code/ Model (Black)	Code/ Model (White)
1000mm	Trimless-recessed Track Rail	ML05-TR1000-B	ML05-TR1000-W
2000mm	Trimless-recessed Track Rail	ML05-TR2000-B	ML05-TR2000-W
3000mm	Trimless-recessed Track Rail	ML05-TR3000-B	ML05-TR3000-W

Accessories

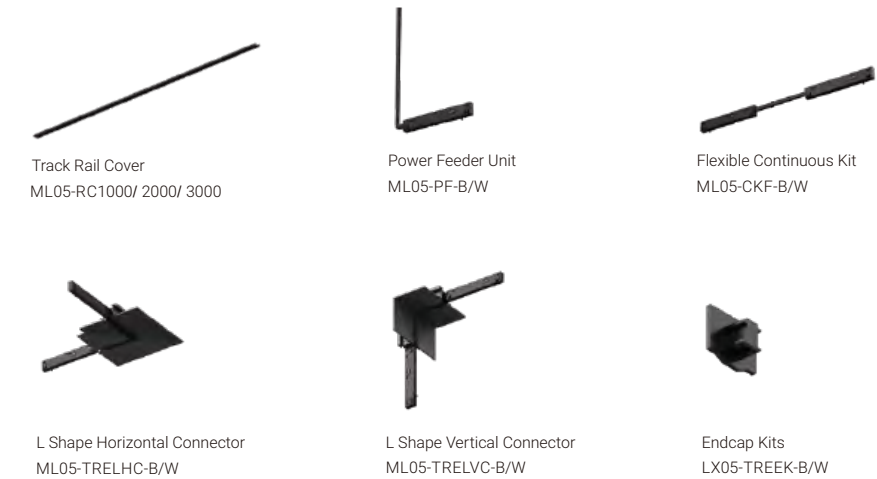

NEW

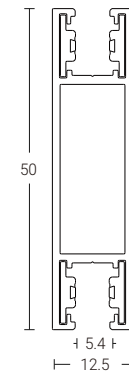

Pendant H Track

Order Info

Length	Description	Code/ Model (Black)	Code/ Model (White)
1000mm	Pendant H Track Rail	ML05-HR1000-B	ML05-HR1000-W
2000mm	Pendant H Track Rail	ML05-HR2000-B	ML05-HR2000-W
3000mm	Pendant H Track Rail	ML05-HR3000-B	ML05-HR3000-W

Accessories

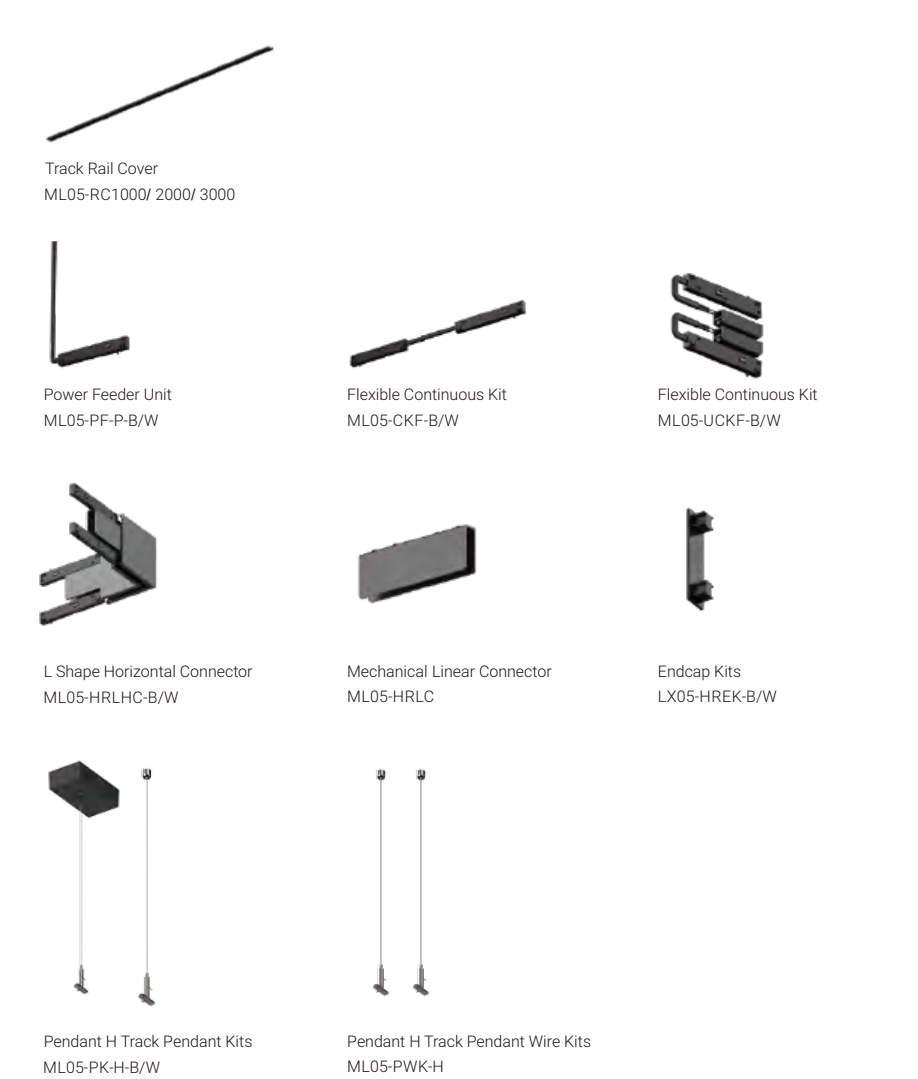

NEW

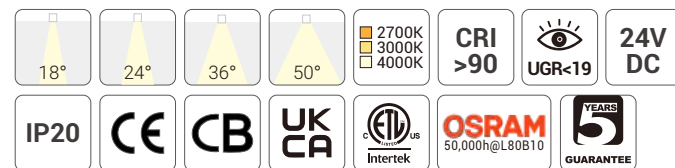

Quick Info

- System: 4W, CRI>90
- CCT: 2700K, 3000K, 4000K Available as Standard
- Beam Angle: 18°, 24°, 36°, 50°
- Lumen Output: Up to 280lm System Luminous Flux
- IP Class: IP20
- LED Driver: On-Off, Phase Dim, 1-10V Dim, DALI Dim

Light Distribution

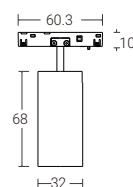
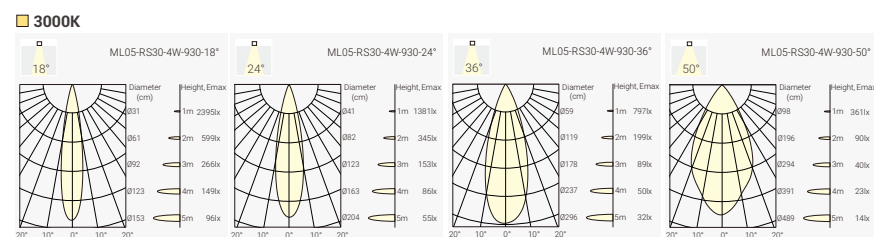

Finish



Order Info (ML05-RS30 in Black Hosing & Black Reflector as an Example)

LED Power	System Power	LED Voltage	CRI	CCT	Beam	LED Output	System Output	Code
3.5W	4W	24V	90	2700K	18°	370lm	250lm	MSR1-9271804N-BB
					24°	370lm	250lm	MSR1-9272404N-BB
					36°	370lm	250lm	MSR1-9273604N-BB
					50°	370lm	250lm	MSR1-9275004N-BB
			3000K	18°	400lm	260lm	MSR1-9301804N-BB	
				24°	400lm	260lm	MSR1-9302404N-BB	
				36°	400lm	260lm	MSR1-9303604N-BB	
				50°	400lm	260lm	MSR1-9305004N-BB	
			4000K	18°	440lm	280lm	MSR1-9401804N-BB	
				24°	440lm	280lm	MSR1-9402404N-BB	
				36°	440lm	280lm	MSR1-9403604N-BB	
				50°	440lm	280lm	MSR1-9405004N-BB	

Code Remark: N=N(No Driver) F=F(ON-OFF) P=P(Phase Dim) A=A(1-10V Dim) D=D(DALI Dim)

Coding

Model	CRI/ CCT	Beam Angle	Power	Control	Finish	Reflector Color	Accessory
MSR1	927	18°	04	N	W	B	H
ML05-RS30	CRI>90/ 2700K	18°	3.5W	No Driver	White	Black	Honeycomb
	930	24°		F	B		
	CRI>90/ 3000K	24°		On-Off	Black		
	940	36°		P			
	CRI>90/ 4000K	36°		Phase Dim			
		50°		A			
		50°		1-10V Dim			
				D			
				DALI Dim			

Optional accessory



Code for MSR1-9301804F with Honeycomb
MSR1-9301804F-H

Honeycomb

NEW

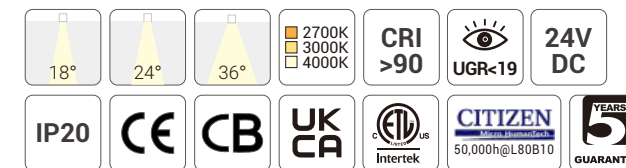

Quick Info

- System: 8W, CRI>90
- CCT: 2700K, 3000K, 4000K Available as Standard
- Beam Angle: 18°, 24°, 36°
- Lumen Output: Up to 600lm System Luminous Flux
- IP Class: IP20
- LED Driver: On-Off, Phase Dim, 1-10V Dim, DALI Dim

Light Distribution

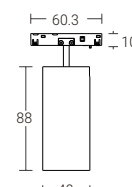
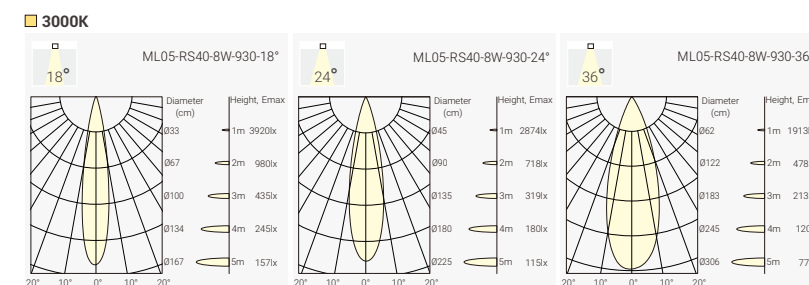

Finish



Order Info (ML05-RS40 in Black Hosing & Black Reflector as an Example)

LED Power	System Power	LED Voltage	CRI	CCT	Beam	LED Output	System Output	Code
7W	8W	24V	90	2700K	18°	900lm	520lm	MSR2-9271808F-BB
					24°	900lm	520lm	MSR2-9271824F-BB
					36°	900lm	520lm	MSR2-9271836F-BB
			3000K	18°	950lm	550lm	MSR2-9301808F-BB	
				24°	950lm	550lm	MSR2-9302408F-BB	
				36°	950lm	550lm	MSR2-9303608F-BB	
			4000K	18°	1000lm	600lm	MSR2-9401808F-BB	
				24°	1000lm	600lm	MSR2-9402408F-BB	
				36°	1000lm	600lm	MSR2-9403608F-BB	

Code Remark: N=N(No Driver) F=F(ON-OFF) P=P(Phase Dim) A=A(1-10V Dim) D=D(DALI Dim)

Coding

Model	CRI/ CCT	Beam Angle	Power	Control	Finish	Reflector Color	Accessory
MSR2	927	18°	08	N	W	B	H
ML05-RS40	CRI>90/ 2700K	18°	8W	No Driver	White	Black	Honeycomb
	930	24°		F	B		
	CRI>90/ 3000K	24°		On-Off	Black		
	940	36°		P			
	CRI>90/ 4000K	36°		Phase Dim			
				A			
				1-10V Dim			
				D			
				DALI Dim			

Optional accessory



Code for MSR2-9301808F with Honeycomb
MSR2-9301808F-H

Honeycomb

NEW



Quick Info

- System: 6W, 12W, CRI>90
- CCT: 2700K, 3000K, 4000K Available as Standard
- Beam Angle: 110°
- Lumen Output: Up to 1000lm System Luminous Flux
- IP Class: IP20
- LED Driver: On-Off, Phase Dim, 1-10V Dim, DALI Dim

Light Distribution

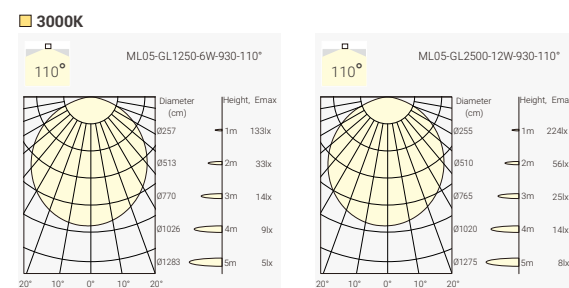

Order Info (ML05-GL1250 in Black Adapter as an Example)

LED Power	System Power	LED Voltage	CRI	CCT	Beam	LED Output	System Output	Code
5W	6W	24V	90	2700K	110°	650lm	230lm	MSG1-927A106N-BN
				3000K	110°	700lm	250lm	MSG1-930A106N-BN
				4000K	110°	750lm	275lm	MSG1-940A106N-BN
11W	12W	24V	90	2700K	110°	1300lm	460lm	MSG2-927A112N-BN
				3000K	110°	1400lm	500lm	MSG2-930A112N-BN
				4000K	110°	1500lm	550lm	MSG2-940A112N-BN

Code Remark: N=N(No Driver) F=F(ON-OFF) P=P(Phase Dim) A=A(1-10V Dim) D=D(DALI Dim)

Coding

Model	CRI/ CCT	Beam Angle	Power	Control	Adapter Finish	Reflector Color	Accessory
MSG1 ML05-GL1250	927 CRI>90/ 2700K	A1 110°	06 6W	N No Driver	W White	N None	
MSG2 ML05-GL2500	930 CRI>90/ 3000K		12 12W	F On-Off	B Black		
	940 CRI>90/ 4000K			P Phase Dim			
				A 1-10V Dim			
				D DALI Dim			

More light insets are coming soon!



MODULINE 26

48V Low Voltage Minimalist Modular Linear Track System
Trim & Trimless Recessed, Surface Mounted,
Pendant, Pendant H Track
Various Light Insets for Different Applications





Project: Carita Project in Paris, France



Project: Cocina Departamento Fray Bernardo, Chile



Project: Private Apartment, Moscow, Russia



Project: NOA, Israel



1 H Track

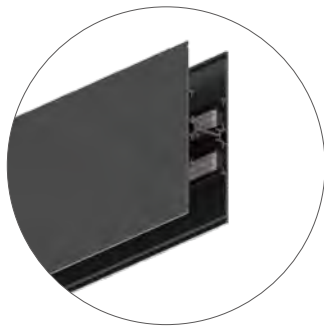

2 Standard Track



3 Slim Track

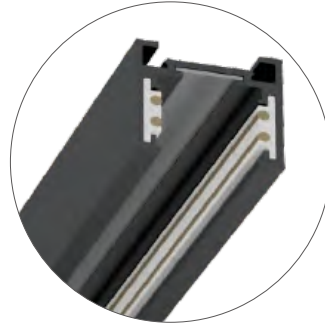

4 Trim Recessed Track

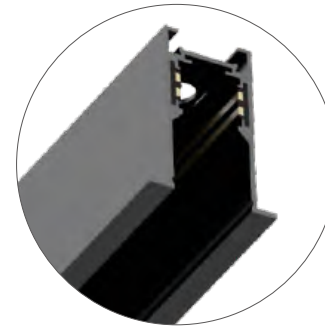

5 Trimless Recessed Track-EI

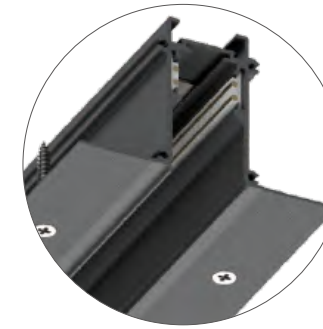

6 Trimless Recessed Track

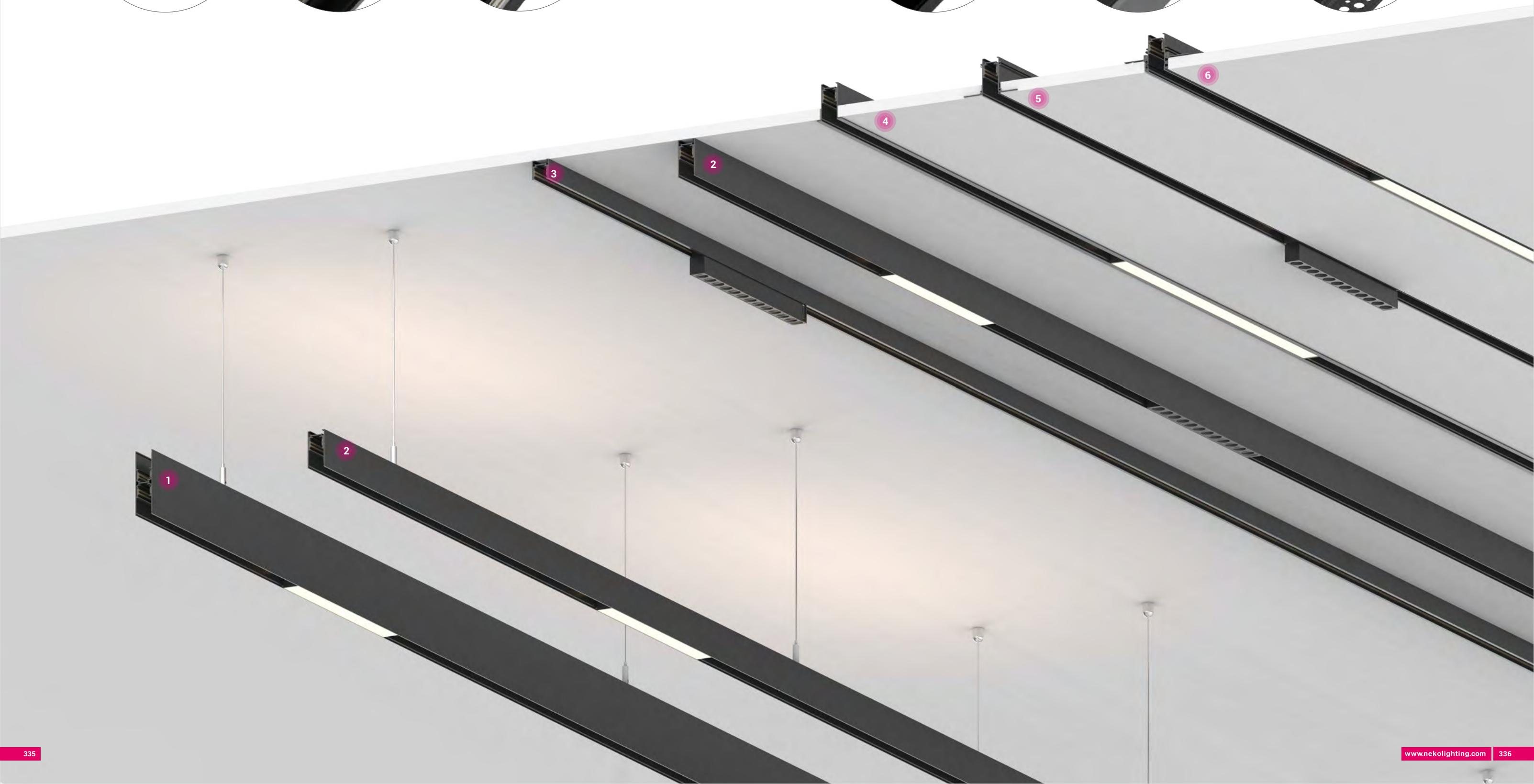
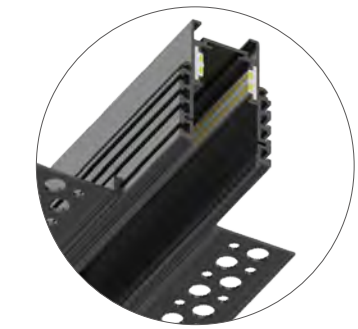

Spotlight Inset

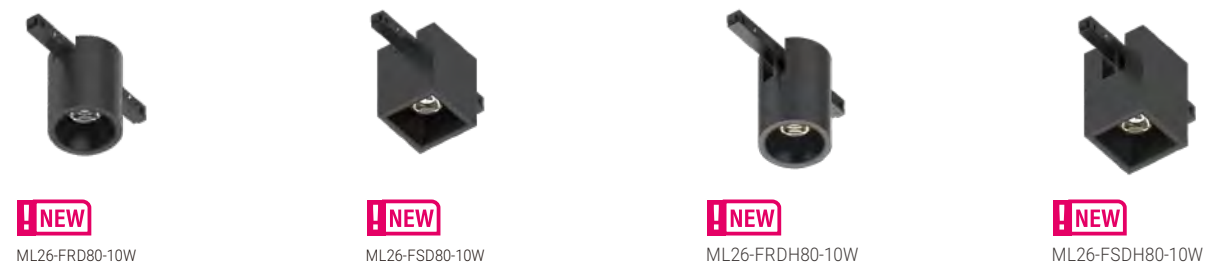

Accent Light Inset

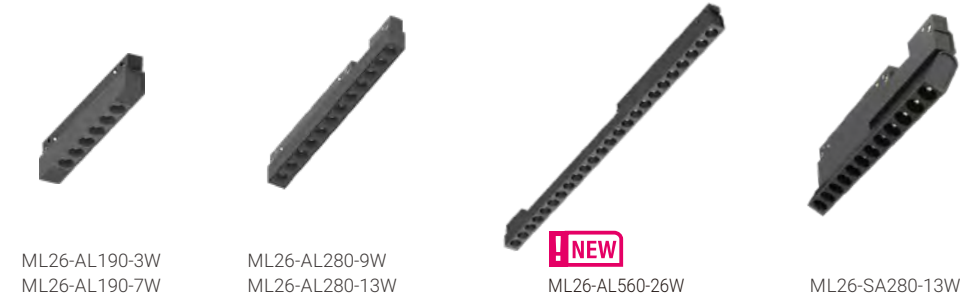

General Light Inset

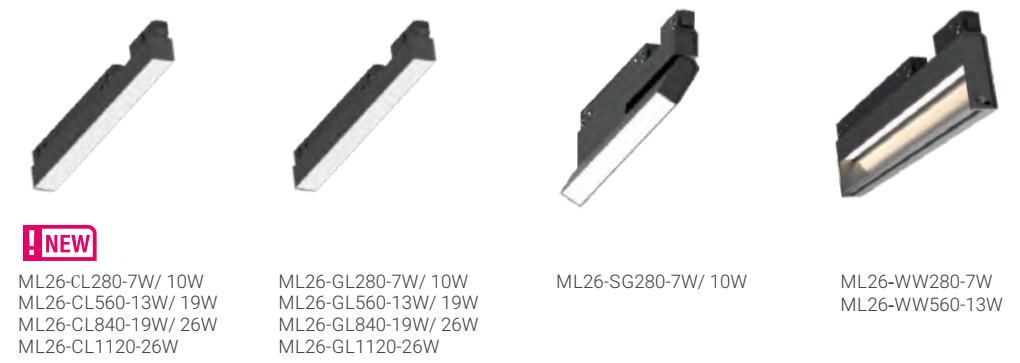

Pendant Light Inset



MODULINE 26 – 48V Low Voltage Modular Linear System

Surface Mounted/ Pendant Version

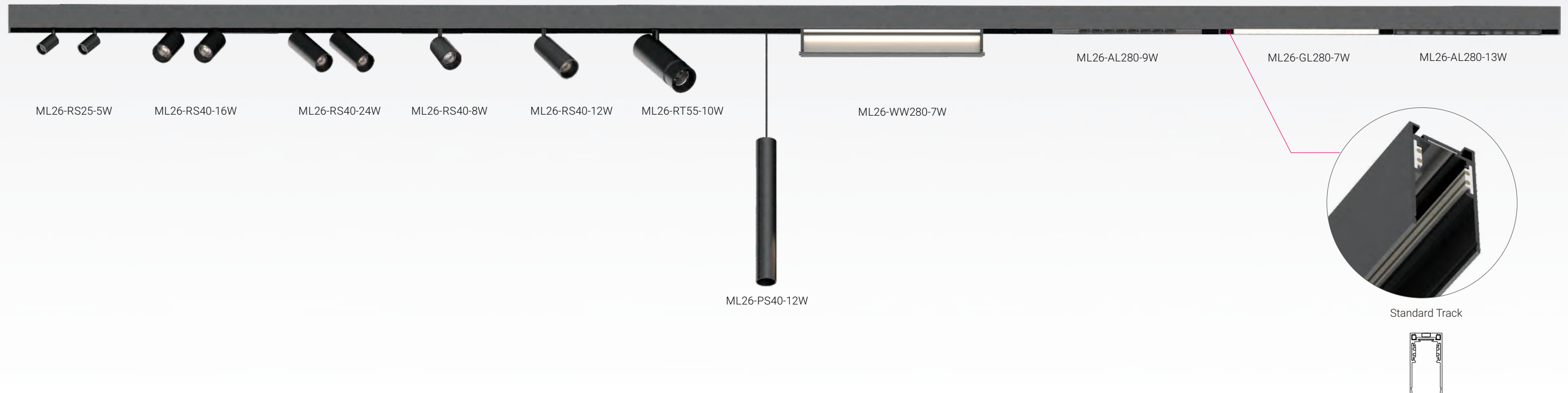

MODULINE 26 – 48V Low Voltage Modular Linear System

Recessed Version

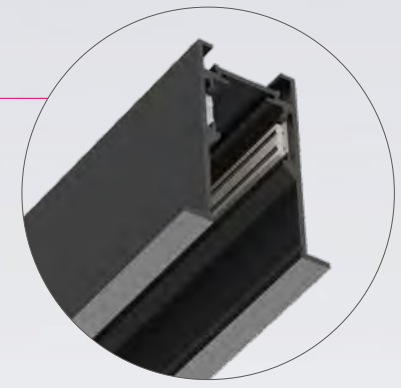

Trim Recessed Track

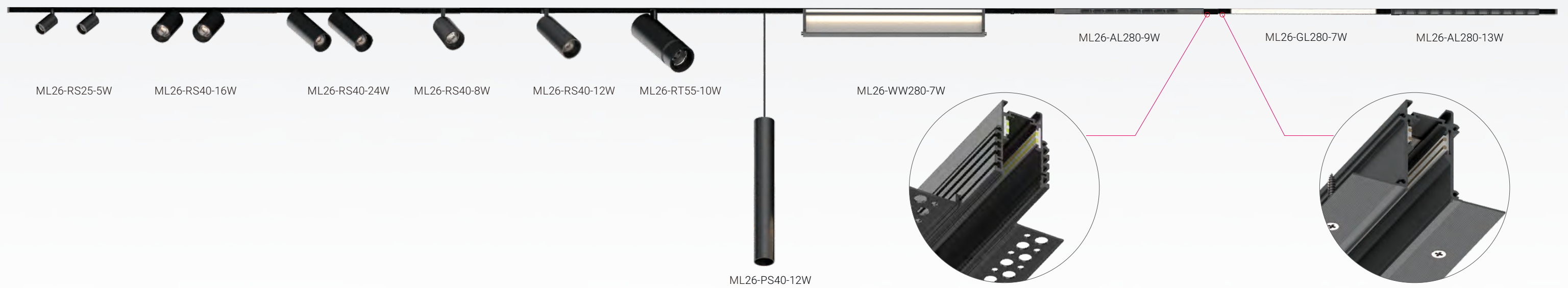
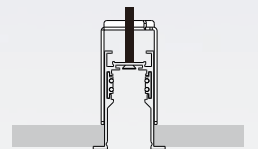

Trimless Recessed Track

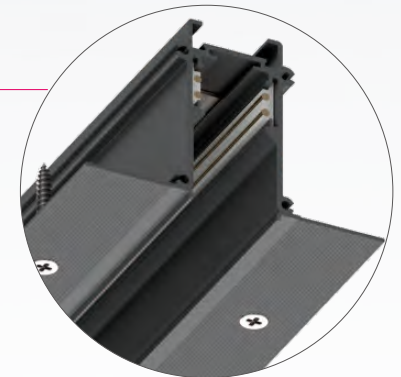
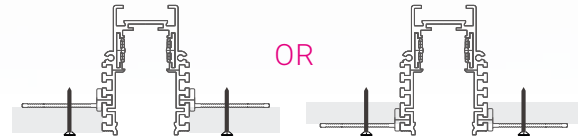

Trimless Recessed Track-EI

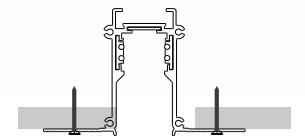

MODULINE 26 – 48V Low Voltage Modular Linear System

Pendant Version-H Track

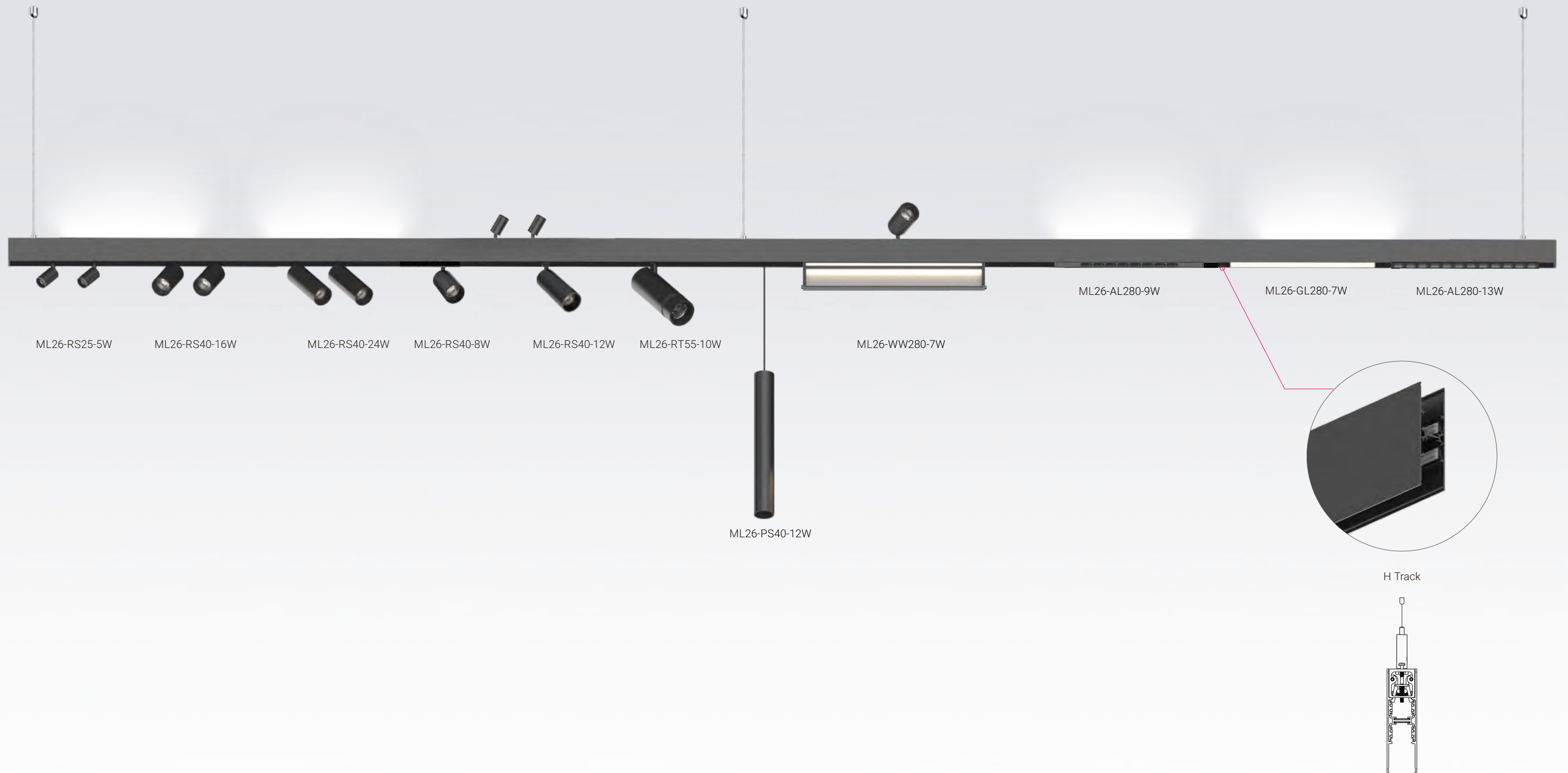

ML26-RS25-5W

ML26-RS40-16W

ML26-RS40-24W

ML26-RS40-8W

ML26-RS40-12W

ML26-RT55-10W

ML26-WW280-7W

ML26-PS40-12W

ML26-AL280-9W

ML26-GL280-7W

ML26-AL280-13W

H Track

MODULINE 26 – 48V Low Voltage Modular Linear System

Slim Track Configuration

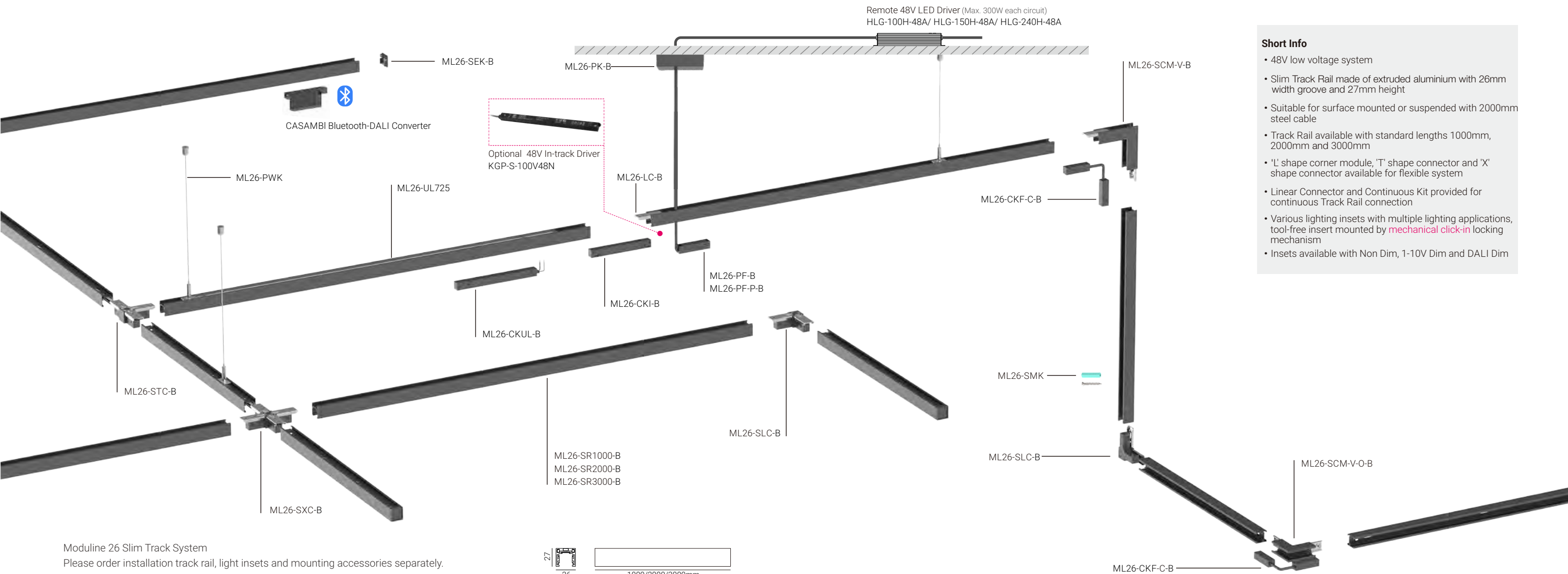

Short Info

- 48V low voltage system
- Slim Track Rail made of extruded aluminium with 26mm width groove and 27mm height
- Suitable for surface mounted or suspended with 2000mm steel cable
- Track Rail available with standard lengths 1000mm, 2000mm and 3000mm
- 'L' shape corner module, 'T' shape connector and 'X' shape connector available for flexible system
- Linear Connector and Continuous Kit provided for continuous Track Rail connection
- Various lighting insets with multiple lighting applications, tool-free insert mounted by **mechanical click-in** locking mechanism
- Insets available with Non Dim, 1-10V Dim and DALI Dim

Moduline 26 Slim Track System

Please order installation track rail, light insets and mounting accessories separately.

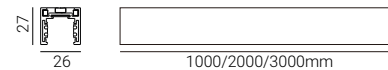

Slim Track System Installation Track Rail | for surface or pendant mounting

Tracks can be shortened on site	Code/ Model (Black-Standard)	Code/ Model (White-Option)
L x W x H : 1000 x 26 x 27mm	ML26-SR1000-B	ML26-SR1000-W
L x W x H : 2000 x 26 x 27mm	ML26-SR2000-B	ML26-SR2000-W
L x W x H : 3000 x 26 x 27mm	ML26-SR3000-B	ML26-SR3000-W

*Track Rail including endcaps.

Accessories of Slim Track System

Vertical 'L' Shape Corner Module-Inner, 80 x 80mm	ML26-SCM-V-B	ML26-SCM-V-W
Vertical 'L' Shape Corner Module-Outer, 80 x 80mm	ML26-SCM-V-O-B	ML26-SCM-V-O-W
'L' Shape Connector Set, 26 x 26mm	ML26-SLC-B	ML26-SLC-W
'T' Shape Connector Set, 26 x 26mm	ML26-STC-B	ML26-STC-W
'X' Shape Connector Set, 26 x 26mm	ML26-SXC-B	ML26-SXC-W
Endcap Kit (2pcs/ set) of Slim Track Rail	ML26-SEK-B	ML26-SEK-W
Power Feeder Unit with feeder cables 500mm for surface mounted	ML26-PF-B	ML26-PF-W
Power Feeder Unit with feeder cables 2000mm for pendant	ML26-PF-P-B	ML26-PF-P-W
Linear Connector with screws	ML26-LC-B	ML26-LC-W
Straight Continuous Kit*, Electrical	ML26-CKI-B	ML26-CKI-W
Flexible Continuous Kit*, Electrical	ML26-CKF-C-B	ML26-CKF-C-W
Surface mounted installation kit, 1set for 1000mm track	ML26-SMK	ML26-SMK
Moduline 26 Pendant Installation Kits, with 1pcs Ceiling Box & 2pcs Pendant Wire (2000mm) Kits	ML26-PK-B	ML26-PK-W
Pendant Wire Kit, Wire in 2000mm Length, 2pcs/ set for 1000mm Track	ML26-PWK	ML26-PWK
48V In-track Driver, KGP48V Constant Voltage 100W LED Driver, Black	KGP-100V48N	
48V In-track Driver, KGP48V Constant Voltage 150W LED Driver, Black	KGP-150V48N	
48V In-track Driver, KGP48V Constant Voltage 250W LED Driver, Black	KGP-250V48N	
48V Remote Driver, Meanwell 48V Constant Voltage 100W LED Driver	HLG-100H-48A	
48V Remote Driver, Meanwell 48V Constant Voltage 150W LED Driver	HLG-150H-48A	
48V Remote Driver, Meanwell 48V Constant Voltage 240W LED Driver	HLG-240H-48A	
CASAMBI Bluetooth-DALI Converter	ML26-CBDC-B	

*Continuous Kit needs to be used together with Linear Connector as a set.

Insets

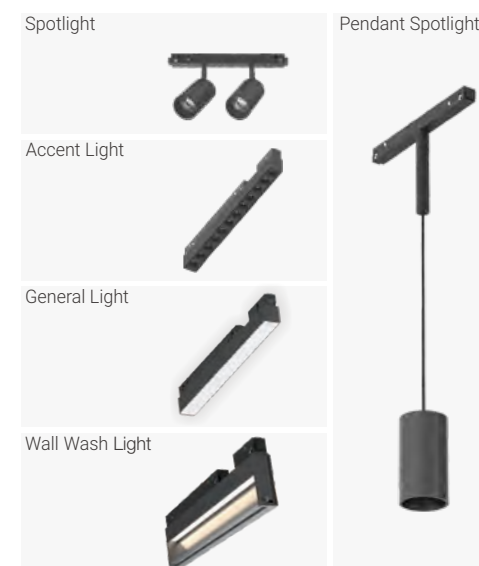

* Check details of light insets at following pages

MODULINE 26 – 48V Low Voltage Modular Linear System

Standard Track Configuration

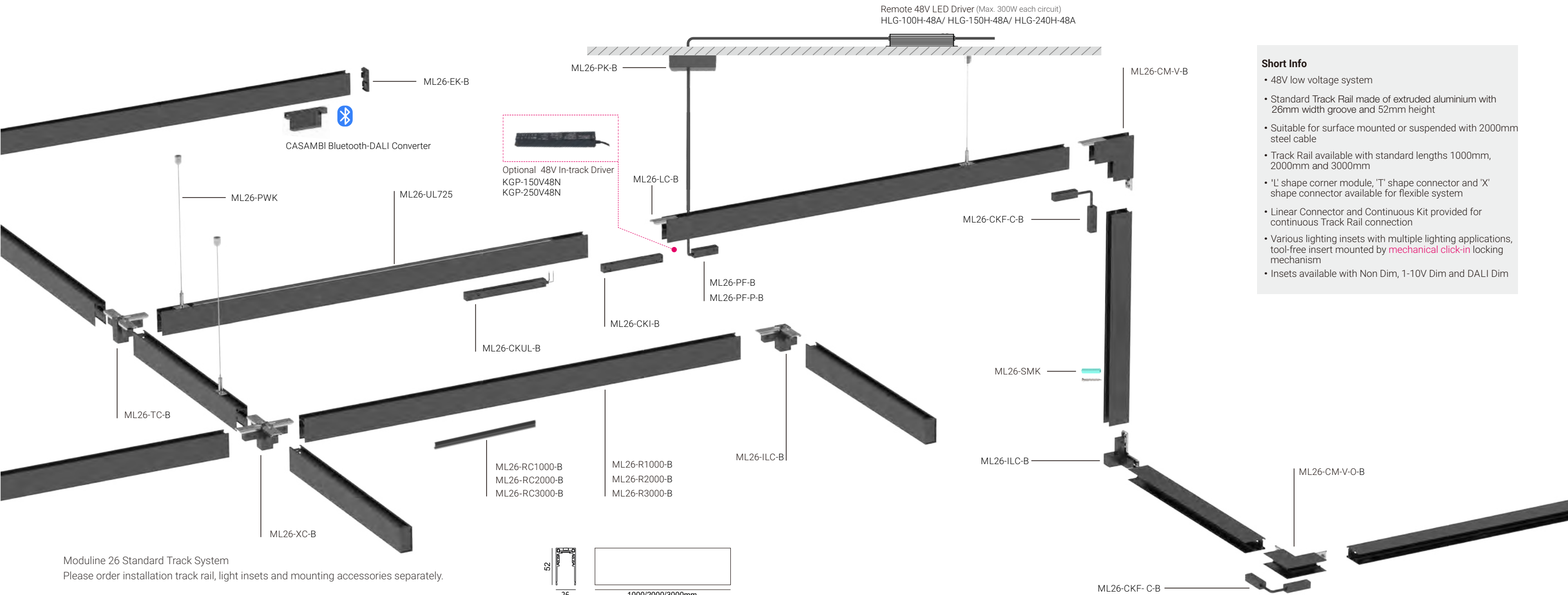

Short Info

- 48V low voltage system
- Standard Track Rail made of extruded aluminium with 26mm width groove and 52mm height
- Suitable for surface mounted or suspended with 2000mm steel cable
- Track Rail available with standard lengths 1000mm, 2000mm and 3000mm
- 'L' shape corner module, 'T' shape connector and 'X' shape connector available for flexible system
- Linear Connector and Continuous Kit provided for continuous Track Rail connection
- Various lighting insets with multiple lighting applications, tool-free insert mounted by **mechanical click-in** locking mechanism
- Insets available with Non Dim, 1-10V Dim and DALI Dim

Moduline 26 Standard Track System
Please order installation track rail, light insets and mounting accessories separately.

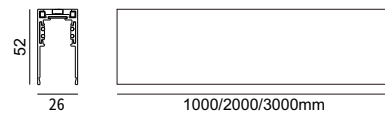

Standard Track System Installation Track Rail | for surface or pendant mounting

Tracks can be shortened on site	Code/ Model (Black-Standard)	Code/ Model (White-Option)
L x W x H : 1000 x 26 x 52mm	ML26-R1000-B	ML26-R1000-W
L x W x H : 2000 x 26 x 52mm	ML26-R2000-B	ML26-R2000-W
L x W x H : 3000 x 26 x 52mm	ML26-R3000-B	ML26-R3000-W

*Track Rail including endcaps.

Accessories of Slim Track System

Vertical 'L' Shape Corner Module-Inner, 80 x 80mm	ML26-CM-V-B	ML26-CM-V-W
Vertical 'L' Shape Corner Module-Outer, 80 x 80mm	ML26-CM-V-O-B	ML26-CM-V-O-W
'L' Shape Connector Set, 26 x 26mm	ML26-ILC-B	ML26-ILC-W
'T' Shape Connector Set, 26 x 26mm	ML26-TC-B	ML26-TC-W
'X' Shape Connector Set, 26 x 26mm	ML26-XC-B	ML26-XC-W
Endcap Kit (2pcs/ set) of Slim Track Rail	ML26-EK-B	ML26-EK-W
Power Feeder Unit with feeder cables 500mm for surface mounted	ML26-PF-B	ML26-PF-W
Power Feeder Unit with feeder cables 2000mm for pendant	ML26-PF-P-B	ML26-PF-P-W
Linear Connector with screws	ML26-LC-B	ML26-LC-W
Straight Continuous Kit*, Electrical	ML26-CKI-B	ML26-CKI-W
Flexible Continuous Kit*, Electrical	ML26-CKF-C-B	ML26-CKF-C-W
Surface mounted installation kit, 1set for 1000mm track	ML26-SMK	ML26-SMK
Moduline 26 Pendant Installation Kits, with 1pcs Ceiling Box & 2pcs Pendant Wire (2000mm) Kits	ML26-PK-B	ML26-PK-W
Pendant Wire Kit, Wire in 2000mm Length, 2pcs/ set for 1000mm Track	ML26-PWK	ML26-PWK
Track Rail Cover 1000mm/2000mm/3000mm, can be shortened at site	ML26-RC1000-B	ML26-RC1000-W
48V In-track Driver, KGP48V Constant Voltage 100W LED Driver, Black	KGP-100V48N	
48V In-track Driver, KGP48V Constant Voltage 150W LED Driver, Black	KGP-150V48N	
48V In-track Driver, KGP48V Constant Voltage 250W LED Driver, Black	KGP-250V48N	
48V Remote Driver, Meanwell 48V Constant Voltage 100W LED Driver	HLG-100H-48A	
48V Remote Driver, Meanwell 48V Constant Voltage 150W LED Driver	HLG-150H-48A	
48V Remote Driver, Meanwell 48V Constant Voltage 240W LED Driver	HLG-240H-48A	
CASAMBI Bluetooth-DALI Converter	ML26-CBDC-B	

*Continuous Kit needs to be used together with Linear Connector as a set.

Insets

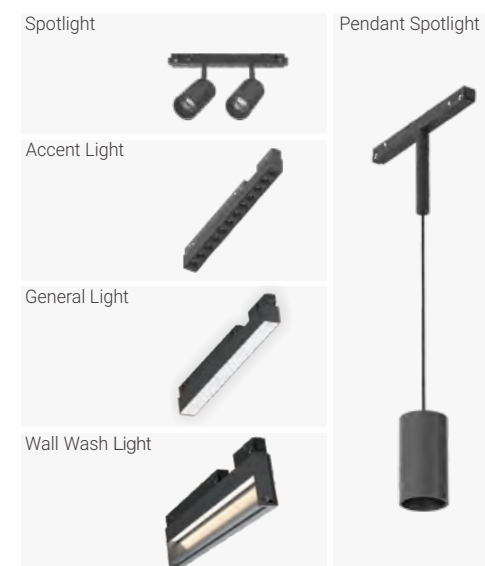

* Check details of light insets at following pages

MODULINE 26 – 48V Low Voltage Modular Linear System

H Track Configuration

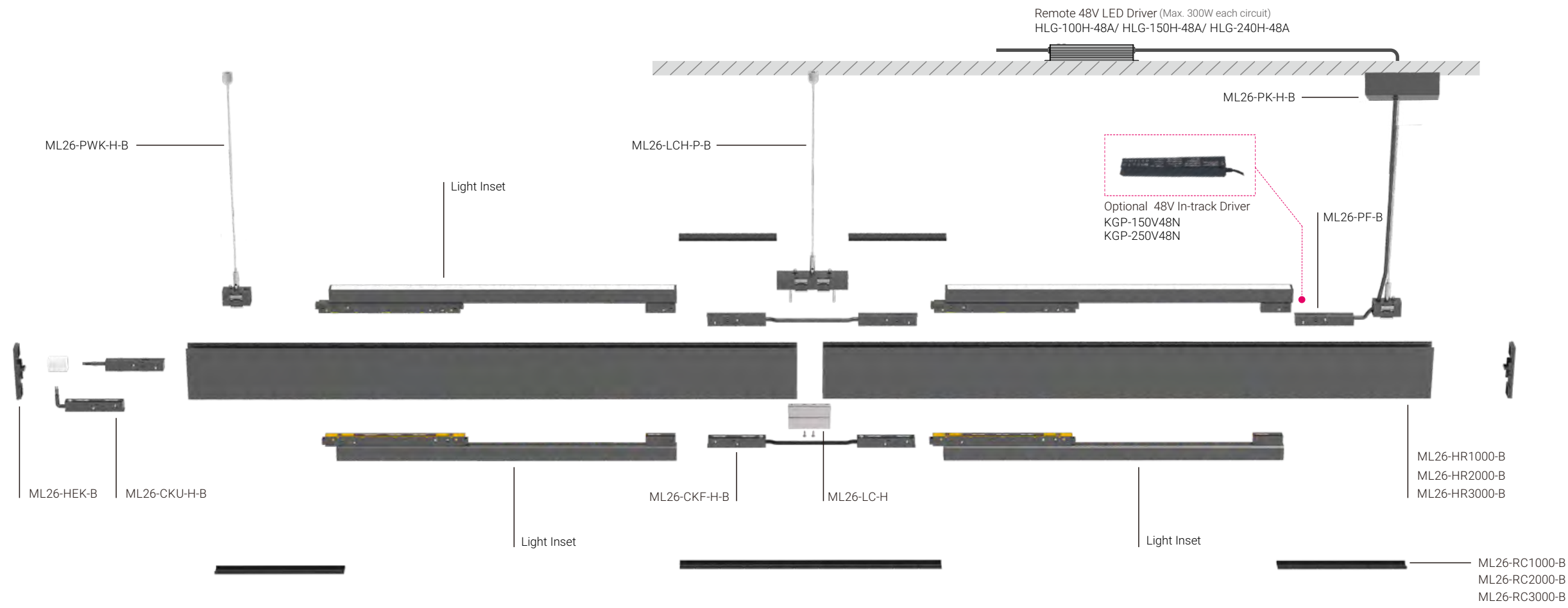

Short Info

- 48V low voltage system
- H Track Rail made of extruded aluminium with 26mm width groove and 90mm height
- Suitable for surface mounted or suspended with 2000mm steel cable
- Track Rail available with standard lengths 1000mm, 2000mm and 3000mm
- Linear Connector and Continuous Kit provided for continuous Track Rail connection
- Various lighting insets with multiple lighting applications, tool-free insert mounted by **mechanical click-in** locking mechanism
- Insets available with Non Dim, 1-10V Dim and DALI Dim

Moduline 26 H Track System

Please order installation track rail, light insets and mounting accessories separately.

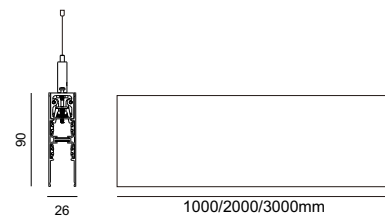

Standard Track System Installation Track Rail | for surface or pendant mounting

Tracks can be shortened on site	Code/ Model (Black-Standard)	Code/ Model (White-Option)
L x W x H : 1000 x 26 x 90mm	ML26-HR1000-B	ML26-HR1000-W
L x W x H : 2000 x 26 x 90mm	ML26-HR2000-B	ML26-HR2000-W
L x W x H : 3000 x 26 x 90mm	ML26-HR3000-B	ML26-HR3000-W

*Track Rail including endcaps.

Accessories of Slim Track System

Endcap Kit (2pcs/ set) of H Track Rail	ML26-HEK-B	ML26-HEK-W
Power Feeder Unit with feeder cables 2000mm for pendant	ML26-PF-P-B	ML26-PF-P-W
Flexible Continuous Kit, Electrical, for Up Track and Down Track connection	ML26-CKU-H-B	ML26-CKU-H-W
Flexible Continuous Kit, Electrical, for straight connection	ML26-CKF-H-B	ML26-CKF-H-W
Linear Connector with Pendant Kit of H Track System	ML26-LCH-P-B	ML26-LCH-P-W
Linear Connector Kit of H Track System*	ML26-LC-H	ML26-LC-H
Moduline 26 Pendant Installation Kits, with 1pcs Ceiling Box & 1pcs H Track Pendant Wire (2000mm) Kits	ML26-PK-H-B	ML26-PK-H-W
H Track Pendant Wire Kit, Wire in 2000mm Length, 2pcs/ set for 1000mm Track	ML26-PWK-H-B	ML26-PWK-H-W
Track Rail Cover 1000mm/2000mm/3000mm, can be shortened at site	ML26-RC1000-B	ML26-RC1000-W
48V In-track Driver, KGP48V Constant Voltage 100W LED Driver, Black	KGP-100V48N	
48V In-track Driver, KGP48V Constant Voltage 150W LED Driver, Black	KGP-150V48N	
48V In-track Driver, KGP48V Constant Voltage 250W LED Driver, Black	KGP-250V48N	
48V Remote Driver, Meanwell 48V Constant Voltage 100W LED Driver	HLG-100H-48A	
48V Remote Driver, Meanwell 48V Constant Voltage 150W LED Driver	HLG-150H-48A	
48V Remote Driver, Meanwell 48V Constant Voltage 240W LED Driver	HLG-240H-48A	

*Linear Connector Kit needs to be used together with Linear Connector with Pendant Kit

Insets

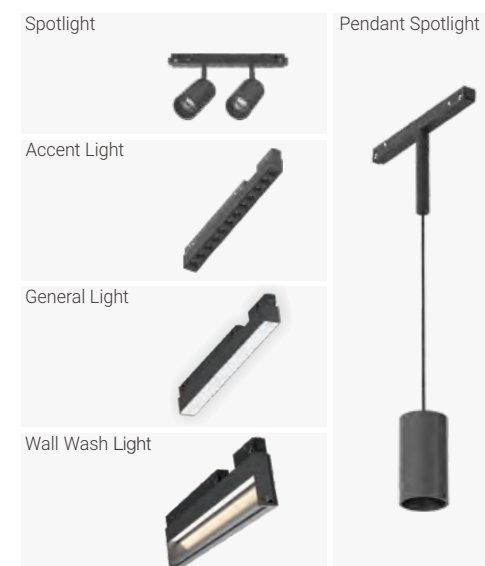

* Check details of light insets at following pages

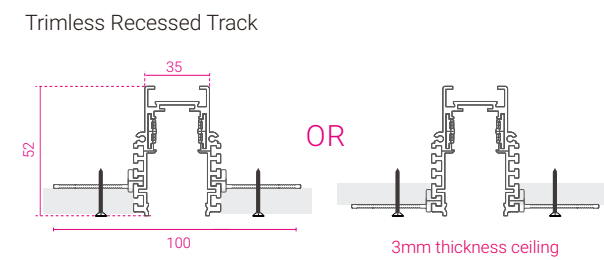
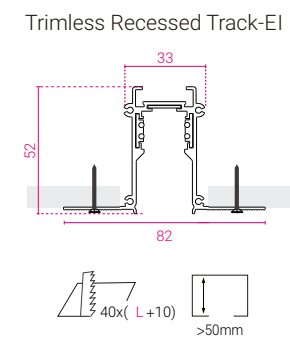
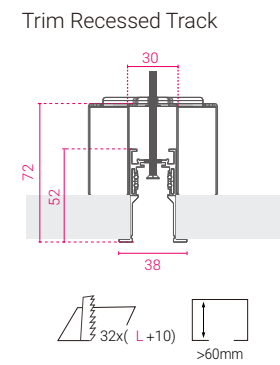
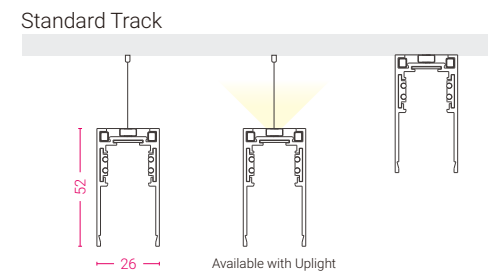
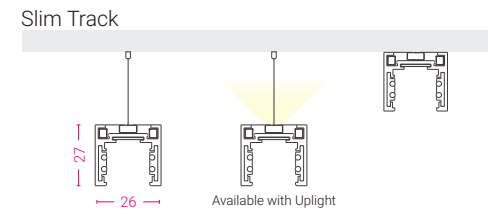

5mm/9mm/12.5mm/15mm/18mm/20mm/25mm thickness ceilings

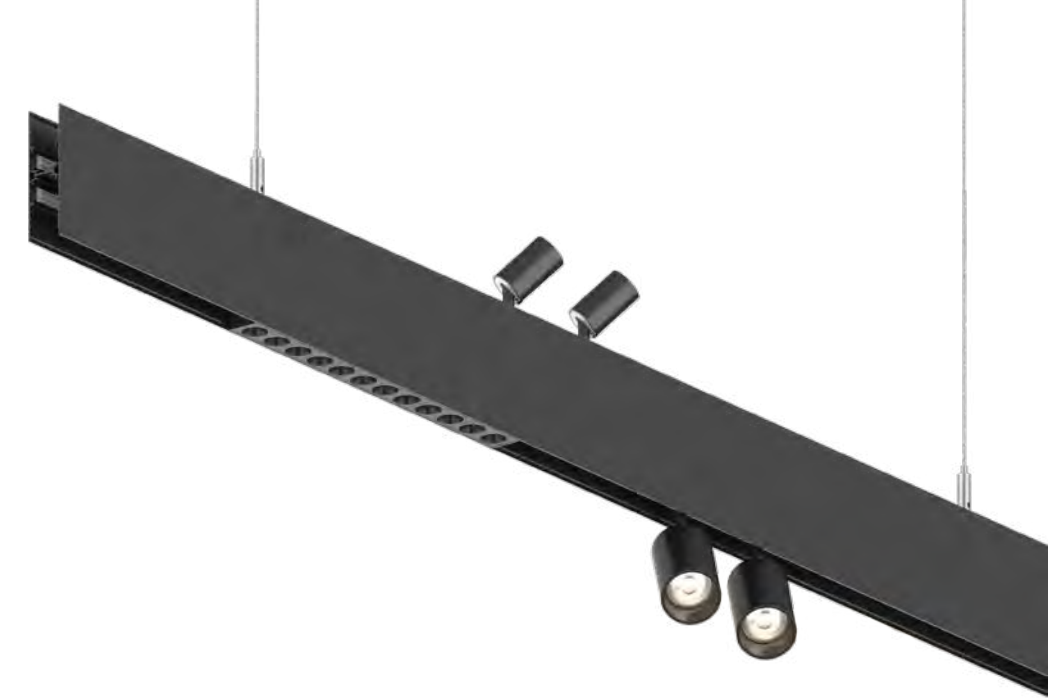
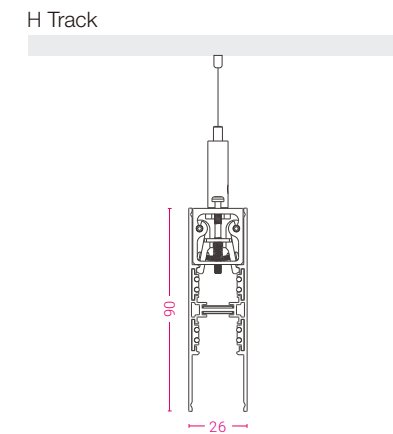
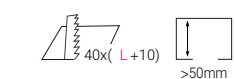

Installations

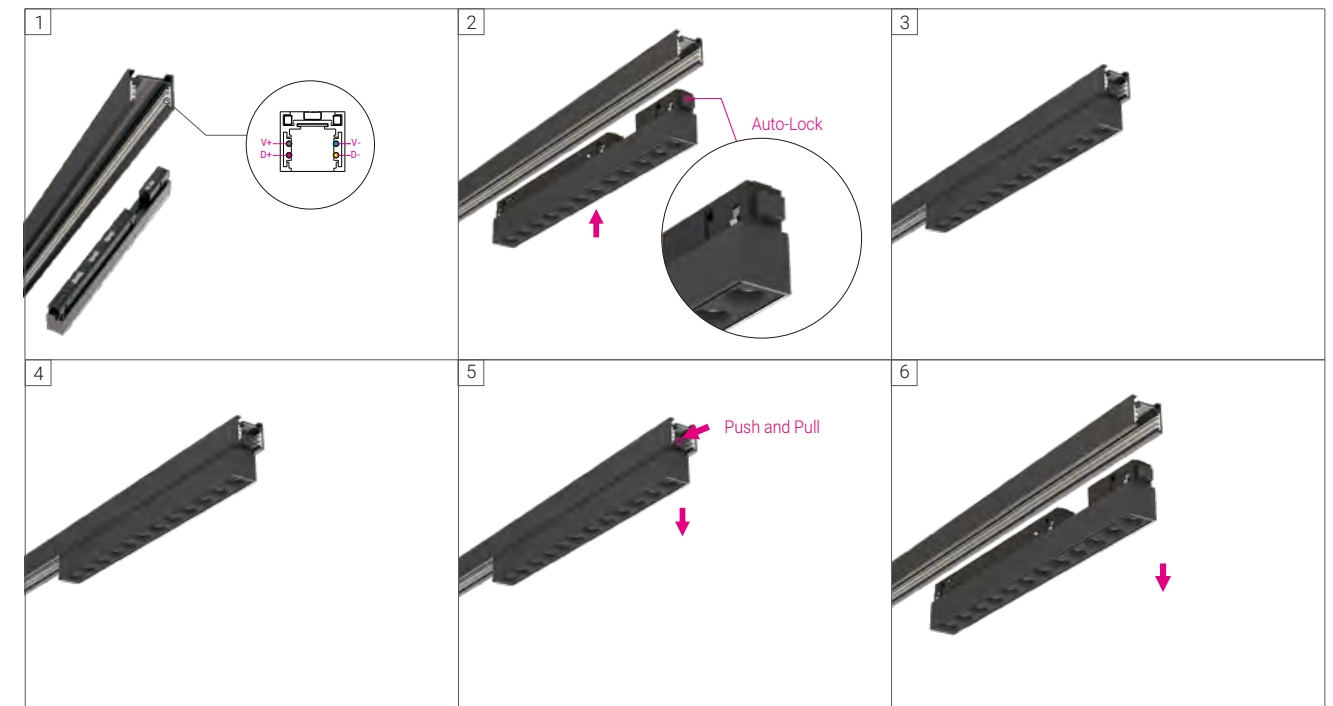

* Tool-free insert mounted by mechanical click-in locking mechanism

MODULINE 26 – 48V Low Voltage Modular Linear System

Recessed Track Configuration



ML26-FCM-V (Trim)
ML26-TCM-V (Trimless)
ML26-TCM-EI-V (Trimless-EI)



ML26-FTC (Trim)
ML26-TTC (Trimless)
ML26-TTC-EI (Trimless-EI)



ML26-FXC (Trim)
ML26-TXC (Trimless)
ML26-TXC-EI (Trimless-EI)



ML26-FCM (Trim)
ML26-TCM (Trimless)
ML26-TCM-EI (Trimless-EI)

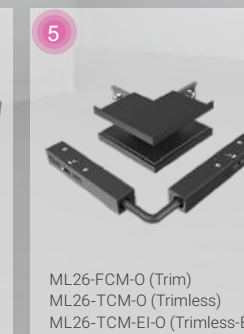

ML26-FCM-O (Trim)
ML26-TCM-O (Trimless)
ML26-TCM-EI-O (Trimless-EI)



ML26-CKI + ML26-LC

MODULINE 26 – 48V Low Voltage Modular Linear System

Trim Recessed Track System

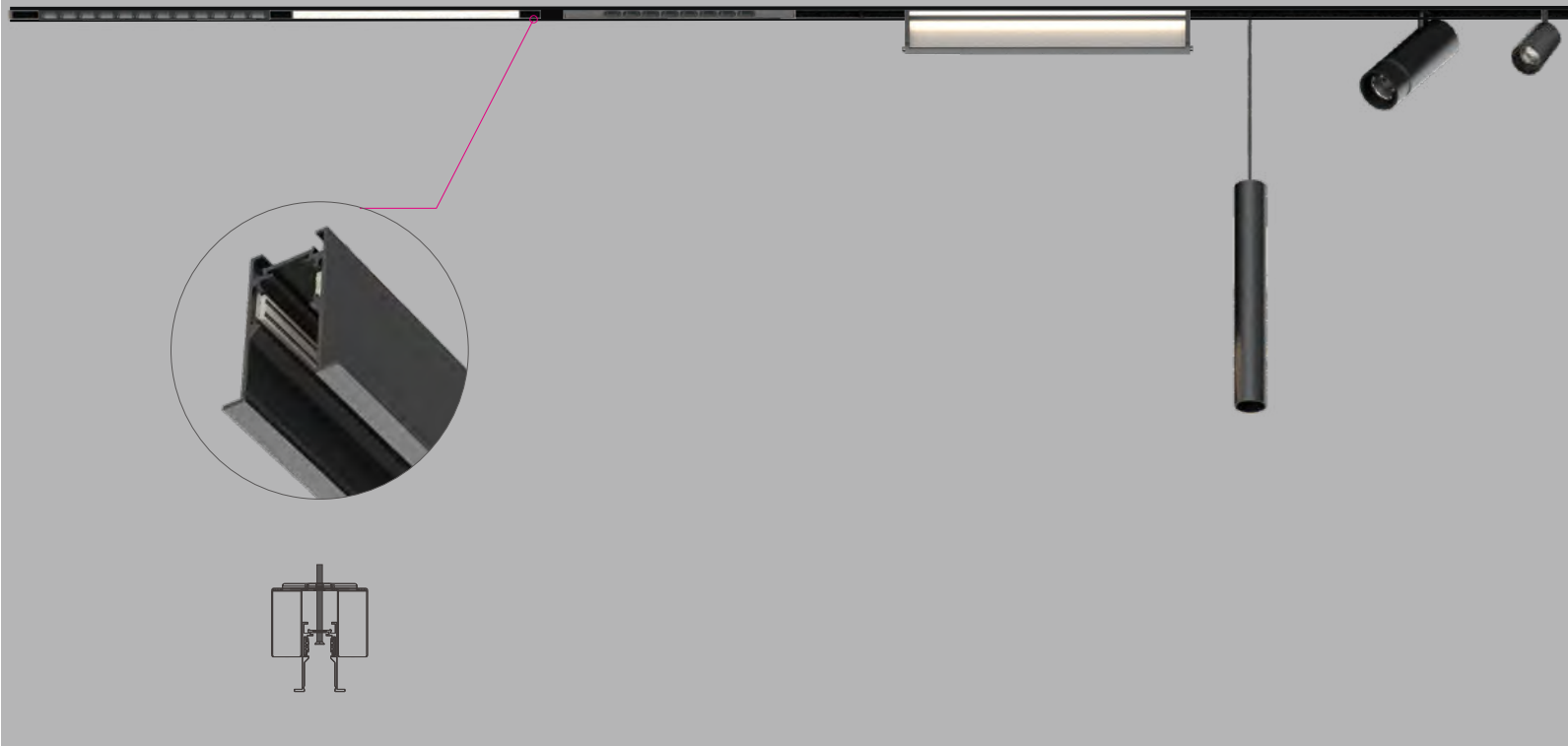

Short Info

- 48V low voltage system
- Trim Recessed Track Rail Version made of extruded aluminium with 26mm width groove and 52mm height
- Mounted from inner track , suitable for all thickness ceiling heights
- Track Rail available with standard lengths 1000mm, 2000mm and 3000mm
- 'L' shape corner module, 'T' shape connector and 'X' shape connector available for flexible system
- Linear Connector and Continuous Kit provided for continuous Track Rail connection
- Various lighting insets with multiple lighting applications, tool-free insert mounted by **mechanical click-in** locking mechanism
- Insets available with Non Dim, 1-10V Dim and DALI Dim

Insets

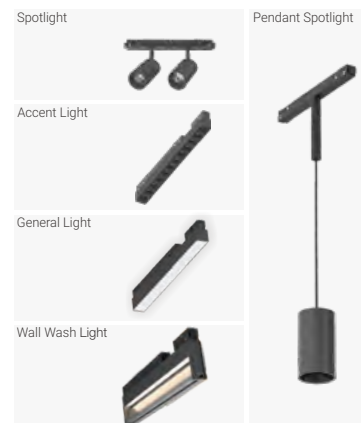

* Check details of light insets at following pages

Features

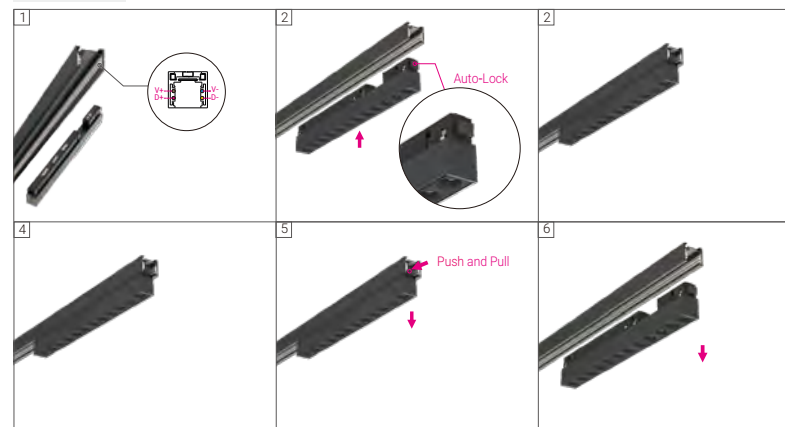

* Tool-free insert mounted by **mechanical click-in** locking mechanism

Short Info

Moduline 26 Trim Recessed Track System

Electrical

Non Dim

1-10V Dim

DALI Dim

Fixture Colour

Black White(Optional)



Moduline 26 Trim Recessed Track System

Please order installation track rail, light insets and mounting accessories separately.

Trim Recessed Track System Version Installation Track Rail

L (mm)	Description	Code/ Model (Black-Standard)	Code/ Model (White-Option)
1000	Trim Recessed Track Rail	ML26-FR1000-B	ML26-FR1000-W
2000	Trim Recessed Track Rail	ML26-FR2000-B	ML26-FR2000-W
3000	Trim Recessed Track Rail	ML26-FR3000-B	ML26-FR3000-W

*Track Rail including endcaps.

Accessories of Trim Recessed Track System

L (mm)	Cutout (mm)	Description	Code/ Model (Black-Standard)	Code/ Model (White-Option)
80x80	(32x28)+(32x28)	Vertical 'L' shape corner module-Inner	ML26-FCM-V-B	ML26-FCM-V-W
80x80	(32x80)+(32x80)	Vertical 'L' shape corner module-Outer	ML26-FCM-O-B	ML26-FCM-O-W
80x80	(32x77)+(32x45)	Horizontal 'L' shape corner module	ML26-FCM-B	ML26-FCM-W
120x80	(32x120)+(32x45)	'T' Shape Connector Set	ML26-FTC-B	ML26-FTC-W
120x120	(32x120)+(32x120)	'X' Shape Connector Set	ML26-FXC-B	ML26-FXC-W
		Flexible Continuous Kit, Electrical *For Corner Connection.	ML26-CKF-C-B	ML26-CKF-C-W
		Trim Recessed Track Rail Mounting Kit, 2pcs/ set	ML26-FIK	ML26-FIK
		Endcap Kit (2pcs/ set) of Trim Recessed Track	ML26-FEK-B	ML26-FEK-W
		Power Feeder Unit with feeder cables 500mm	ML26-PF-B	ML26-PF-W
		Track Rail Cover 1000mm	ML26-RC1000-B	ML26-RC1000-W
		Track Rail Cover 2000mm	ML26-RC2000-B	ML26-RC2000-W
		Track Rail Cover 3000mm	ML26-RC3000-B	ML26-RC3000-W
		*Track Rail Cover can be shortened as desired.		
		Linear Connector with screws	ML26-RLC-B	ML26-RLC-W
		Straight Continuous Kit*, Electrical *Continuous Kit needs to be used together with Linear Connector as a set.	ML26-CKI-B	ML26-CKI-W
		48V In-track Driver, KGP48V Constant Voltage 100W LED Driver, Black	KGP-100V48N	
		48V In-track Driver, KGP48V Constant Voltage 150W LED Driver, Black	KGP-150V48N	
		48V In-track Driver, KGP48V Constant Voltage 250W LED Driver, Black	KGP-250V48N	
		48V Remote Driver, Meanwell 48V Constant Voltage 100W LED Driver	HLG-100H-48A	
		48V Remote Driver, Meanwell 48V Constant Voltage 150W LED Driver	HLG-150H-48A	
		48V Remote Driver, Meanwell 48V Constant Voltage 240W LED Driver	HLG-240H-48A	
		CASAMBI Bluetooth-DALI Converter Max. 64 DALI Light Insets Divided into 8 Groups. Each Group Can be Controlled Separately. LxH: 143x58mm	ML26-CBDC-B	

MODULINE 26 – 48V Low Voltage Modular Linear System

Trimless Recessed Track System
Ceiling Thickness Adjustable Version

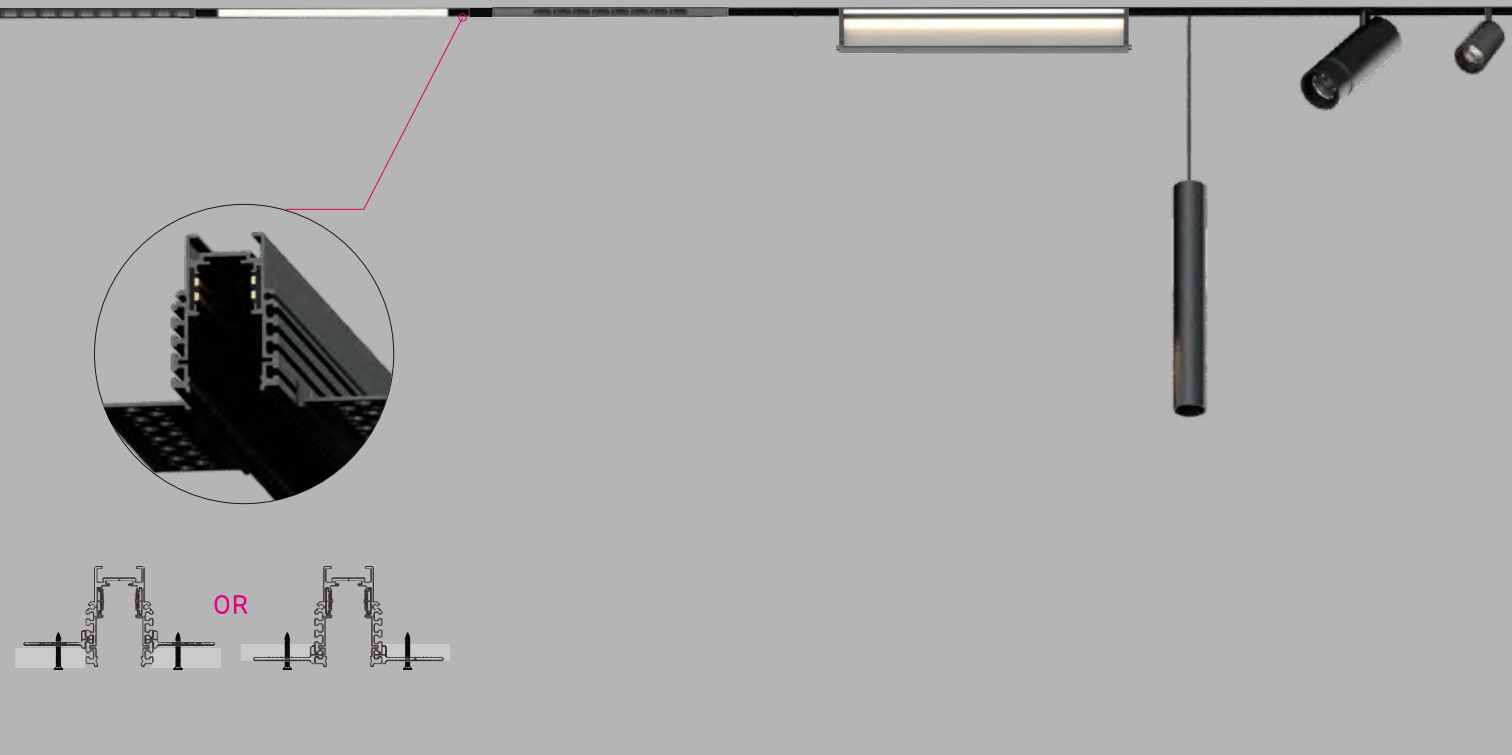

Short Info

- 48V low voltage system
- Trimless Recessed Track Rail Version made of extruded aluminium with 35mm width groove and 52mm height
- Suitable for 3mm/5mm/9mm/12.5mm/15mm/18mm/20mm/25mm thickness ceilings heights
- Track Rail available with standard lengths 1000mm, 2000mm and 3000mm
- 'L' shape corner module, 'T' shape connector and 'X' shape connector available for flexible system
- Linear Connector and Continuous Kit provided for continuous Track Rail connection
- Various lighting insets with multiple lighting applications, tool-free insert mounted by **mechanical click-in** locking mechanism
- Insets available with Non Dim, 1-10V Dim and DALI Dim

Insets

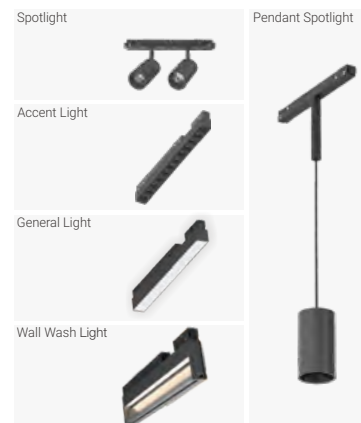

* Check details of light insets at following pages

Features

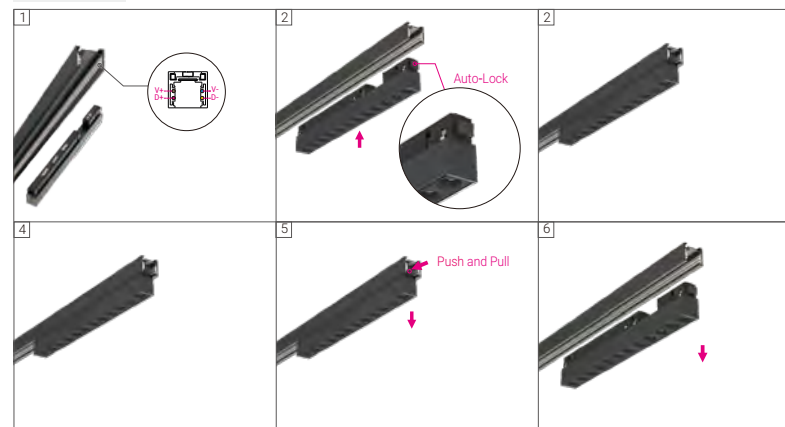

* Tool-free insert mounted by **mechanical click-in** locking mechanism

Short Info

Moduline 26 Trimless Recessed Track System
Ceiling Thickness Adjustable



Moduline 26 Trimless Recessed Track System
Ceiling Thickness Adjustable

Please order installation track rail, light insets and mounting accessories separately.

Electrical

Non Dim

1-10V Dim

DALI Dim

Fixture Colour

Black White(Option)

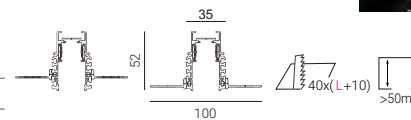

Trimless Recessed Track System Ceiling Thickness Adjustable Version Installation Track Rail

L (mm)	Description	Code/ Model (Black-Standard)	Code/ Model (White-Option)
1000	Trimless Recessed Track Rail	ML26-TAR1000-B	ML26-TAR1000-W
2000	Trimless Recessed Track Rail	ML26-TAR2000-B	ML26-TAR2000-W
3000	Trimless Recessed Track Rail	ML26-TAR3000-B	ML26-TAR3000-W

*Track Rail including endcaps.

Accessories of Ceiling Thickness Adjustable Trimless Recessed Track System

L (mm)	Cutout (mm)	Description	Code/ Model (Black-Standard)	Code/ Model (White-Option)
80x80	(40x28)+(40x28)	Vertical 'L' shape corner module-Inner	ML26-TACM-V-B	ML26-TACM-V-W
80x80	(40x80)+(40x80)	Vertical 'L' shape corner module-Outer	ML26-TACM-O-B	ML26-TACM-O-W
80x80	(40x82)+(40x42)	Horizontal 'L' shape corner module	ML26-TACM-B	ML26-TACM-W
80x120	(40x120)+(40x42)	'T' Shape Connector Set	ML26-TATC-B	ML26-TATC-W
120x120	(40x120)+(40x120)	'X' Shape Connector Set	ML26-TAXC-B	ML26-TAXC-W
		Flexible Continuous Kit, Electrical *For Corner Connection.	ML26-CKF-C-B	ML26-CKF-C-W
		Endcap Kit (2pcs/ set) of Trim Recessed Track	ML26-TAEK-B	ML26-TAEK-W
		Power Feeder Unit with feeder cables 500mm	ML26-PF-B	ML26-PF-W
		Track Rail Cover 1000mm	ML26-RC1000-B	ML26-RC1000-W
		Track Rail Cover 2000mm	ML26-RC2000-B	ML26-RC2000-W
		Track Rail Cover 3000mm	ML26-RC3000-B	ML26-RC3000-W
		*Track Rail Cover can be shortened as desired.		
		Linear Connector with screws	ML26-RLC-B	ML26-RLC-W
		Straight Continuous Kit*, Electrical	ML26-CKI-B	ML26-CKI-W
		*Continuous Kit needs to be used together with Linear Connector as a set.		
		Trimless Recessed installation kit 1set for 1000mm track	ML26-TAIK	ML26-TAIK
		48V In-track Driver, KGP48V Constant Voltage 100W LED Driver, Black	KGP-100V48N	
		48V In-track Driver, KGP48V Constant Voltage 150W LED Driver, Black	KGP-150V48N	
		48V In-track Driver, KGP48V Constant Voltage 250W LED Driver, Black	KGP-250V48N	
		48V Remote Driver, Meanwell 48V Constant Voltage 100W LED Driver	HLG-100H-48A	
		48V Remote Driver, Meanwell 48V Constant Voltage 150W LED Driver	HLG-150H-48A	
		48V Remote Driver, Meanwell 48V Constant Voltage 240W LED Driver	HLG-240H-48A	
		CASAMBI Bluetooth-DALI Converter Max. 64 DALI Light Insets Divided into 8 Groups. Each Group Can be Controlled Separately. LxH: 143x58mm	ML26-CBDC-B	

MODULINE 26 – 48V Low Voltage Modular Linear System

Trimless Recessed Track System-EI
Easy Installation Version

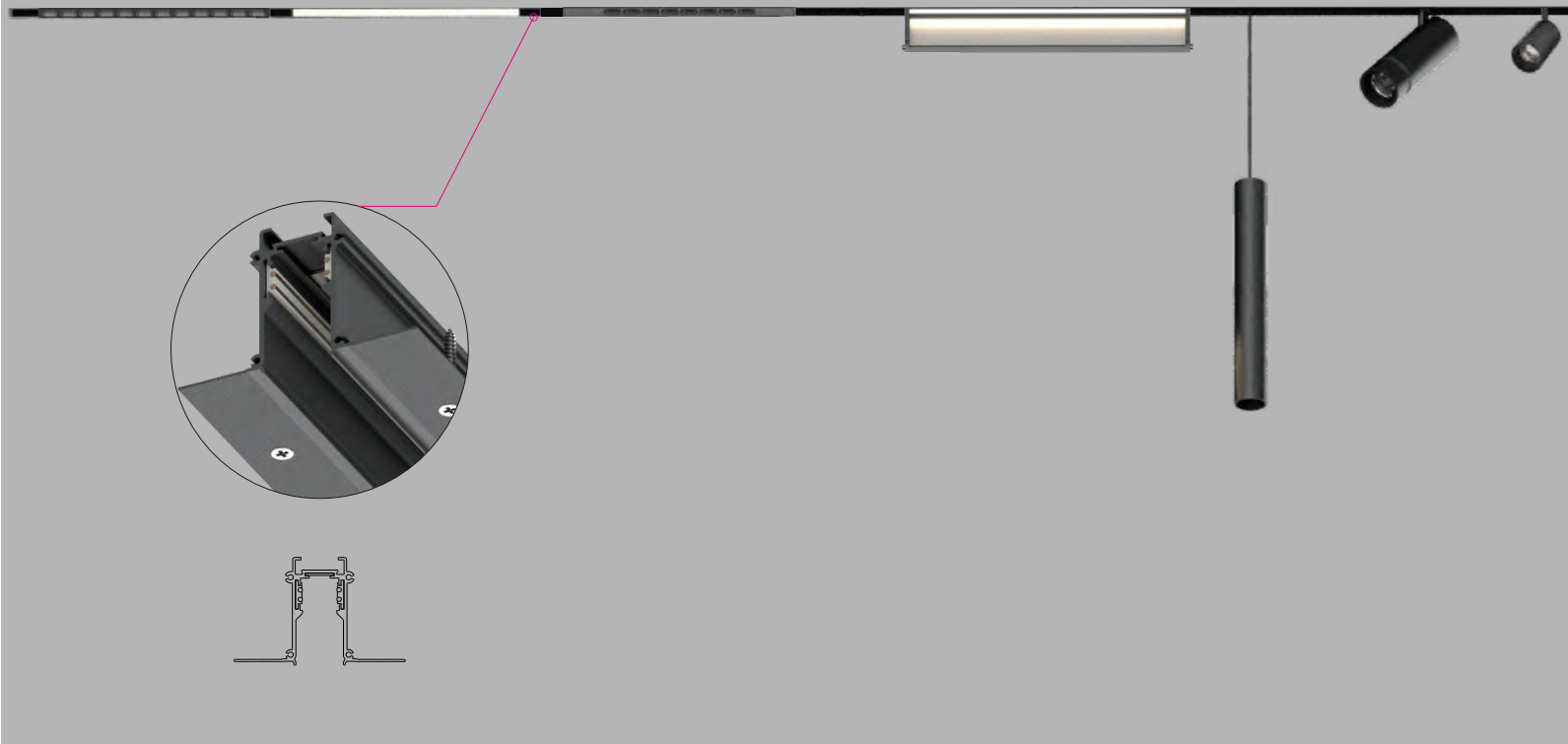

Short Info

- 48V low voltage system
- Trimless Recessed Track Rail Easy Installation Version made of extruded aluminium with 26mm width groove and 52mm height
- Mounted from surface, suitable for all thickness ceiling heights
- Track Rail available with standard lengths 1000mm, 2000mm and 3000mm
- 'L' shape corner module, 'T' shape connector and 'X' shape connector available for flexible system
- Linear Connector and Continuous Kit provided for continuous Track Rail connection
- Various lighting insets with multiple lighting applications, tool-free insert mounted by **mechanical click-in** locking mechanism
- Insets available with Non Dim, 1-10V Dim and DALI Dim

Insets

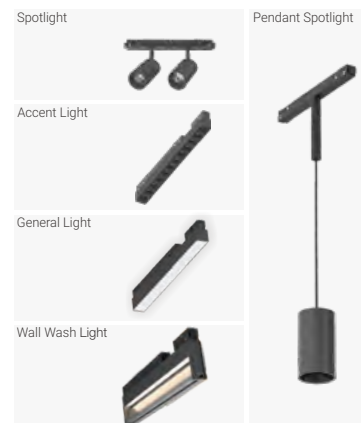

* Check details of light insets at following pages

Features

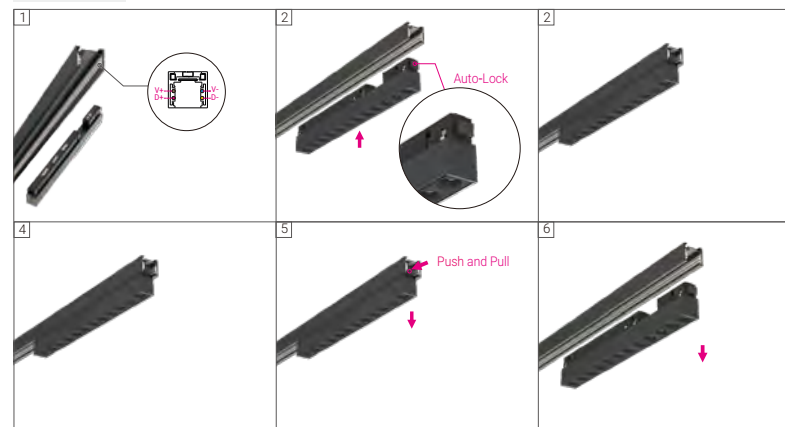

* Tool-free insert mounted by **mechanical click-in** locking mechanism

Short Info

**Moduline 26 Trimless Recessed Track System
Easy Installation Version**

Electrical

Non Dim

1-10V Dim

DALI Dim

Fixture Colour

Black White(Option)

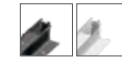

**Moduline 26 Trimless Recessed Track System
Easy Installation Version**

Please order installation track rail, light insets and mounting accessories separately.

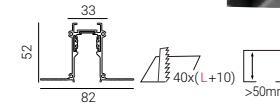

Trimless Recessed Track System Easy Installation Version Installation Track Rail

L (mm)	Description	Code/ Model (Black-Standard)	Code/ Model (White-Option)
1000	Trimless Recessed Track Rail-EI	ML26-TR1000-EI-B	ML26-TR1000-EI-W
2000	Trimless Recessed Track Rail-EI	ML26-TR2000-EI-B	ML26-TR2000-EI-W
3000	Trimless Recessed Track Rail-EI	ML26-TR3000-EI-B	ML26-TR3000-EI-W

*Track Rail including endcaps.

Accessories of Easy Installation Version Trimless Recessed Track System

L (mm)	Cutout (mm)	Description	Code/ Model (Black-Standard)	Code/ Model (White-Option)
100x100	(40x48)+(40x48)	Vertical 'L' shape corner module-Inner	ML26-TCM-EI-V-B	ML26-TCM-EI-V-W
100x100	(40x100)+(40x100)	Vertical 'L' shape corner module-Outer	ML26-TCM-EI-O-B	ML26-TCM-EI-O-W
100x100	(40x80)+(40x40)	Horizontal 'L' shape corner module	ML26-TCM-EI-B	ML26-TCM-EI-W
100x120	(40x120)+(40x40)	'T' Shape Connector Set	ML26-TTC-EI-B	ML26-TTC-EI-W
120x120	(40x120)+(40x120)	'X' Shape Connector Set	ML26-TXC-EI-B	ML26-TXC-EI-W
		Flexible Continuous Kit, Electrical	ML26-CKF-C-B	ML26-CKF-C-W
		*For Corner Connection.		
		Endcap Kit (2pcs/ set) of Trim Recessed Track	ML26-TEK-EI-B	ML26-TEK-EI-W
		Power Feeder Unit with feeder cables 500mm	ML26-PF-B	ML26-PF-W
		Track Rail Cover 1000mm	ML26-RC1000-B	ML26-RC1000-W
		Track Rail Cover 2000mm	ML26-RC2000-B	ML26-RC2000-W
		Track Rail Cover 3000mm	ML26-RC3000-B	ML26-RC3000-W
		*Track Rail Cover can be shortened as desired.		
		Linear Connector with screws	ML26-RLC-B	ML26-RLC-W
		Straight Continuous Kit*, Electrical	ML26-CKI-B	ML26-CKI-W
		*Continuous Kit needs to be used together with Linear Connector as a set.		
		Trimless Recessed Track mounting kit 1set for 1000mm track	ML26-RMK	ML26-RMK
		48V In-track Driver, KGP48V Constant Voltage 100W LED Driver, Black	KGP-100V48N	
		48V In-track Driver, KGP48V Constant Voltage 150W LED Driver, Black	KGP-150V48N	
		48V In-track Driver, KGP48V Constant Voltage 250W LED Driver, Black	KGP-250V48N	
		48V Remote Driver, Meanwell 48V Constant Voltage 100W LED Driver	HLG-100H-48A	
		48V Remote Driver, Meanwell 48V Constant Voltage 150W LED Driver	HLG-150H-48A	
		48V Remote Driver, Meanwell 48V Constant Voltage 240W LED Driver	HLG-240H-48A	
		CASAMBI Bluetooth-DALI Converter Max. 64 DALI Light Insets Divided into 8 Groups. Each Group Can be Controlled Separately. LxH: 143x58mm	ML26-CBDC-B	

MODULINE 26 – ML26-RS25 Spotlight Inset

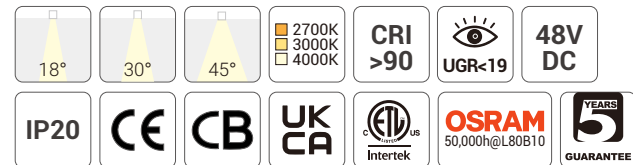

Quick Info

- System: 3W, 5W, CRI>90
- CCT: 2700K, 3000K, 4000K Available as Standard
- Beam Angle: 18°, 30°, 45°
- Lumen Output: Up to 380lm System Luminous Flux
- IP Class: IP20
- Versions: On-Off, 1-10V Dim, DALI Dim

Light Distribution

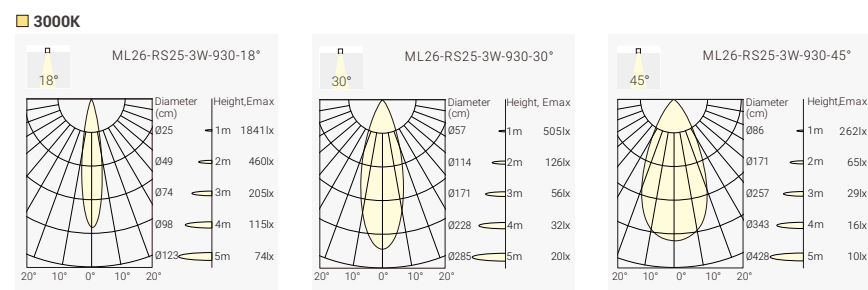

Finish

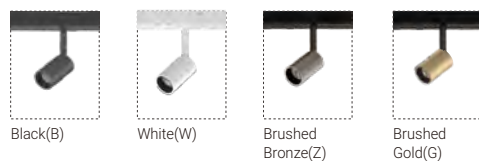

Order Info (ML26-RS25 in Black Hosing & Black Reflector as an Example)

LED Power	System Power	LED Voltage	CRI	CCT	Beam	LED Output	System Output	Code					
2W	3W	48V	90	2700K	18°	220lm	170lm	MLR0-9271803F-BB					
					30°	220lm	170lm	MLR0-9273003F-BB					
					45°	220lm	170lm	MLR0-9274503F-BB					
					3000K	18°	230lm	180lm	MLR0-9301803F-BB				
						30°	230lm	180lm	MLR0-9303003F-BB				
						45°	230lm	180lm	MLR0-9304503F-BB				
					4000K	18°	250lm	190lm	MLR0-9401803F-BB				
						30°	250lm	190lm	MLR0-9403003F-BB				
						45°	250lm	190lm	MLR0-9404503F-BB				
					4W	5W	48V	90	2700K	18°	420lm	330lm	MLR1-9271805F-BB
										30°	420lm	330lm	MLR1-9273005F-BB
										45°	420lm	330lm	MLR1-9274505F-BB
3000K	18°	450lm	350lm	MLR1-9301805F-BB									
	30°	450lm	350lm	MLR1-9303005F-BB									
	45°	450lm	350lm	MLR1-9304505F-BB									
4000K	18°	500lm	380lm	MLR1-9401805F-BB									
	30°	500lm	380lm	MLR1-9403005F-BB									
	45°	500lm	380lm	MLR1-9404505F-BB									

Code Remark: F=F(ON-OFF) A=A(1-10V Dim) D=D(DALI Dim)

Optional accessory

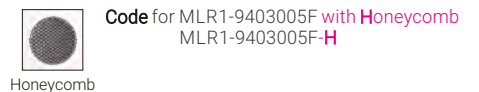

Coding

Model	CRI/ CCT	Beam Angle	Power	Control	Finish	Reflector Color	Accessory
MLR0 ML26-RS25-3W Single Spot	927 CRI>90/ 2700K	18°	03 3W	F On-Off	W White	B Black	H Honeycomb
MLR1 ML26-RS25-5W Double Spot	930 CRI>90/ 3000K	30°	05 5W	A 1-10V Dim	B Black		
	940 CRI>90/ 4000K	45°		D DALI Dim	Z Brushed Bronze		
					G Brushed Gold		

MODULINE 26 – ML26-RS40 Spotlight Inset

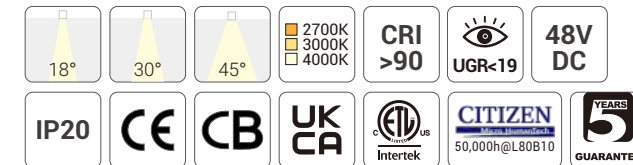

Quick Info

- System: 8W, 16W, CRI>90
- CCT: 2700K, 3000K, 4000K Available as Standard
- Beam Angle: 18°, 30°, 45°
- Lumen Output: Up to 1200lm System Luminous Flux
- IP Class: IP20
- Versions: On-Off, 1-10V Dim, DALI Dim

Light Distribution

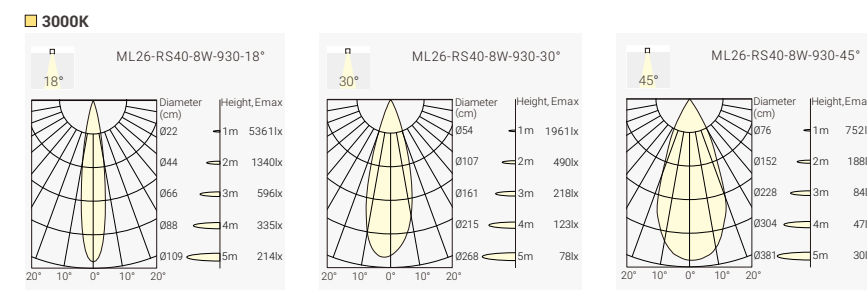

Finish

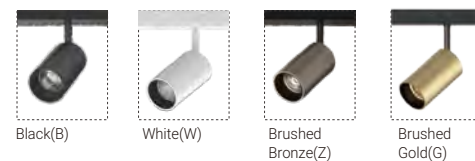

Order Info (ML26-RS40 in Black Hosing & Black Reflector as an Example)

LED Power	System Power	LED Voltage	CRI	CCT	Beam	LED Output	System Output	Code					
7.5W	8W	48V	90	2700K	18°	700lm	550lm	MLR2-9271808F-BB					
					30°	700lm	550lm	MLR2-9273008F-BB					
					45°	700lm	550lm	MLR2-9274508F-BB					
					3000K	18°	750lm	580lm	MLR2-9301808F-BB				
						30°	750lm	580lm	MLR2-9303008F-BB				
						45°	750lm	580lm	MLR2-9304508F-BB				
					4000K	18°	800lm	640lm	MLR2-9401808F-BB				
						30°	800lm	640lm	MLR2-9403008F-BB				
						45°	800lm	640lm	MLR2-9404508F-BB				
					15W	16W	48V	90	2700K	18°	1400lm	1000lm	MLR3-9271816F-BB
										30°	1400lm	1000lm	MLR3-9273016F-BB
										45°	1400lm	1000lm	MLR3-9274516F-BB
3000K	18°	1500lm	1100lm	MLR3-9301816F-BB									
	30°	1500lm	1100lm	MLR3-9303016F-BB									
	45°	1500lm	1100lm	MLR3-9304516F-BB									
4000K	18°	1600lm	1200lm	MLR3-9401816F-BB									
	30°	1600lm	1200lm	MLR3-9403016F-BB									
	45°	1600lm	1200lm	MLR3-9404516F-BB									

Code Remark: F=F(ON-OFF) A=A(1-10V Dim) D=D(DALI Dim)

Optional accessory

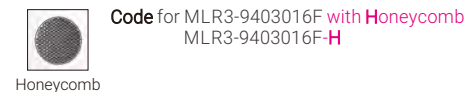

Coding

Model	CRI/ CCT	Beam Angle	Power	Control	Finish	Reflector Color	Accessory
MLR2 ML26-RS40-8W Single Spot	927 CRI>90/ 2700K	18°	08 8W	F On-Off	W White	B Black	H Honeycomb
MLR3 ML26-RS40-16W Double Spot	930 CRI>90/ 3000K	30°	16 16W	A 1-10V Dim	B Black		
	940 CRI>90/ 4000K	45°		D DALI Dim	Z Brushed Bronze		
					G Brushed Gold		

MODULINE 26 – ML26-RS40 Spotlight Inset



Quick Info

- System: 12W, 24W, CRI>90
- CCT: 2700K, 3000K, 4000K Available as Standard
- Beam Angle: 18°, 30°, 45°
- Lumen Output: Up to 1600lm System Luminous Flux
- IP Class: IP20
- Versions: On-Off, 1-10V Dim, DALI Dim

Light Distribution

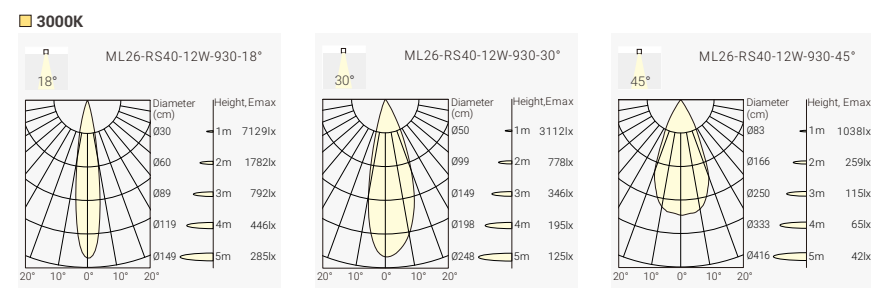

Finish

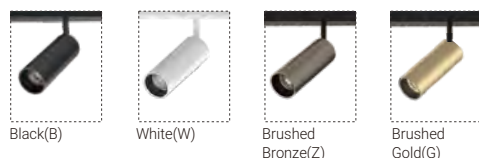

Order Info (ML26-RS40 in Black Hosing & Black Reflector as an Example)

LED Power	System Power	LED Voltage	CRI	CCT	Beam	LED Output	System Output	Code				
11W	12W	48V	90	2700K	18°	1000lm	700lm	MLR4-9271812F-BB				
					30°	1000lm	700lm	MLR4-9273012F-BB				
					45°	1000lm	550lm	MLR4-9274512F-BB				
					18°	1100lm	750lm	MLR4-9301812F-BB				
					30°	1100lm	750lm	MLR4-9303012F-BB				
					45°	1100lm	600lm	MLR4-9304512F-BB				
			4000K	18°	1200lm	800lm	MLR4-9401812F-BB					
				30°	1200lm	800lm	MLR4-9403012F-BB					
				45°	1200lm	650lm	MLR4-9404512F-BB					
				22W	24W	48V	90	2700K	18°	2000lm	1400lm	MLR5-9271824F-BB
									30°	2000lm	1400lm	MLR5-9273024F-BB
									45°	2000lm	1100lm	MLR5-9274524F-BB
18°	2200lm	1500lm	MLR5-9301824F-BB									
30°	2200lm	1500lm	MLR5-9303024F-BB									
45°	2200lm	1200lm	MLR5-9304524F-BB									
4000K	18°	2400lm	1600lm				MLR5-9401824F-BB					
	30°	2400lm	1600lm				MLR5-9403024F-BB					
	45°	2400lm	1300lm				MLR5-9404524F-BB					

Code Remark: F=(ON-OFF) A=A(1-10V Dim) D=D(DALI Dim)

Optional accessory

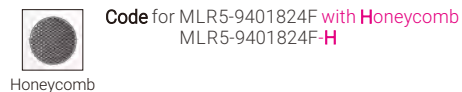

Coding

MLR4 - *** ** * - * * - *

Model	CRI/ CCT	Beam Angle	Power	Control	Finish	Reflector Color	Accessory
MLR4 ML26-RS40-12W Single Spot	927 CRI>90/ 2700K	18° 18°	12 12W	F On-Off	W White	B Black	H Honeycomb
MLR5 ML26-RS40-24W Double Spot	930 CRI>90/ 3000K	30° 30°	24 24W	A 1-10V Dim	B Black		
	940 CRI>90/ 4000K	45° 45°		D DALI Dim	Z Brushed Bronze G Brushed Gold		



Project: Office Crescent Fund, Singapore

MODULINE 26 – ML26-RT55 Spotlight Inset



Quick Info

- System: 10W, CRI>90
- CCT: 2700K, 3000K, 4000K Available as Standard
- Beam Angle: 20°-40°, 35°-60°, Zooming Spot
- Lumen Output: Up to 1200lm System Luminous Flux
- IP Class: IP20
- Versions: On-Off, 1-10V Dim, DALI Dim

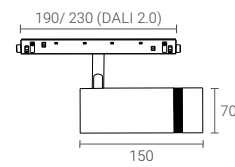

Light Distribution

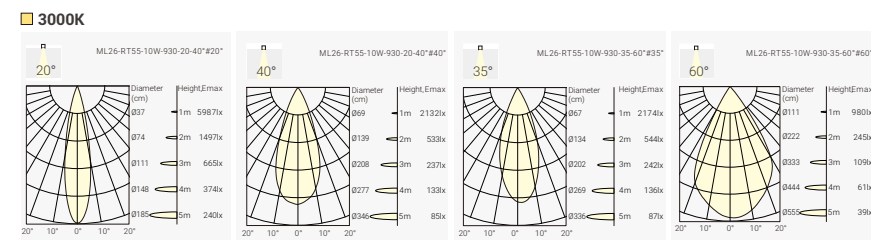

Finish



Optional accessory

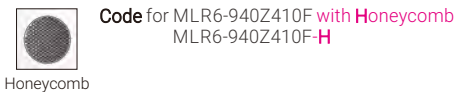

Order Info (ML26-RT55 in Black Hosing & Black Reflector as an Example)

LED Power	System Power	LED Voltage	CRI	CCT	Beam	LED Output	System Output	Code
9W	10W	48V	90	2700K	20°-40°	1200lm	1000lm	MLR6-927Z410F-BB
					35°-60°	1200lm	950lm	MLR6-927Z610F-BB
				3000K	20°-40°	1300lm	1100lm	MLR6-930Z410F-BB
					35°-60°	1300lm	1000lm	MLR6-930Z610F-BB
				4000K	20°-40°	1400lm	1200lm	MLR6-940Z410F-BB
					35°-60°	1400lm	1100lm	MLR6-940Z610F-BB

Code Remark: F=F(ON-OFF) A=A(1-10V Dim) D=D(DALI Dim)

Coding

Model	CRI/ CCT	Beam Angle	Power	Control	Finish	Reflector Color	Accessory
MLR6	927	Z4	10	F	W	B	
ML26-RS55-10W	CRI>90/ 2700K	20°~40°	10W	On-Off	White	Black	
	930	Z6		A	B		
	CRI>90/ 3000K	35°~60°		1-10V Dim	Black		
	940			D			
	CRI>90/ 4000K			DALI Dim			

MODULINE 26 – ML26-RS55 Spotlight Inset

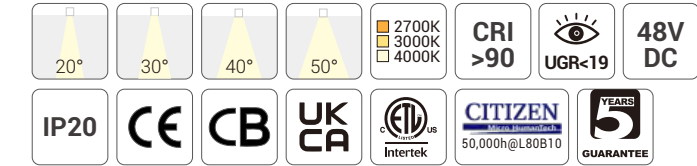

Quick Info

- System: 14W, CRI>90
- CCT: 2700K, 3000K, 4000K Available as Standard
- Beam Angle: 20°, 30°, 40°, 50°
- Lumen Output: Up to 1300lm System Luminous Flux
- IP Class: IP20
- Versions: On-Off, 1-10V Dim, DALI Dim

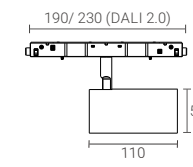

Light Distribution

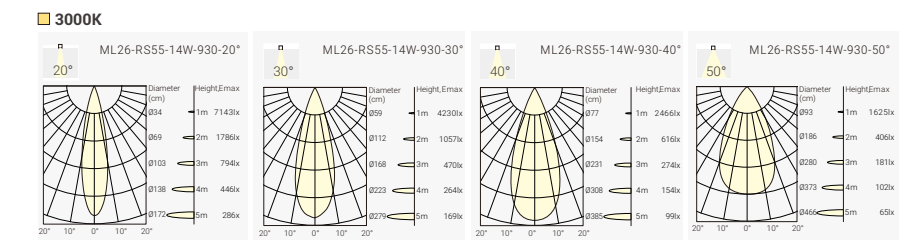

Finish



Optional accessory

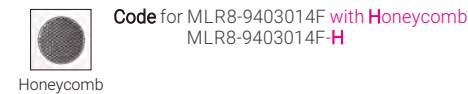

Order Info (ML26-RS55 in Black Hosing & Black Reflector as an Example)

LED Power	System Power	LED Voltage	CRI	CCT	Beam	LED Output	System Output	Code
12W	14W	48V	90	2700K	20°	1400lm	1100lm	MLR8-9272014F-BB
					30°	1400lm	1100lm	MLR8-9273014F-BB
					40°	1400lm	1100lm	MLR8-9274014F-BB
					50°	1400lm	1050lm	MLR8-9275014F-BB
				3000K	20°	1500lm	1200lm	MLR8-9302014F-BB
					30°	1500lm	1200lm	MLR8-9303014F-BB
					40°	1500lm	1200lm	MLR8-9304014F-BB
					50°	1500lm	1100lm	MLR8-9305014F-BB
				4000K	20°	1600lm	1300lm	MLR8-9402014F-BB
					30°	1600lm	1300lm	MLR8-9403014F-BB
					40°	1600lm	1300lm	MLR8-9404014F-BB
					50°	1600lm	1200lm	MLR8-9405014F-BB

Code Remark: F=F(ON-OFF) A=A(1-10V Dim) D=D(DALI Dim)

Coding

Model	CRI/ CCT	Beam Angle	Power	Control	Finish	Reflector Color	Accessory
MLR8	927	20	14	F	W	B	H
ML26-RS55-14W	CRI>90/ 2700K	20°	14W	On-Off	White	Black	Honeycomb
	930	30		A	B		
	CRI>90/ 3000K	30°		1-10V Dim	Black		
	940	40		D			
	CRI>90/ 4000K	40°		DALI Dim			
		50					
		50°					

MODULINE 26 – ML26-RS72 Spotlight Inset

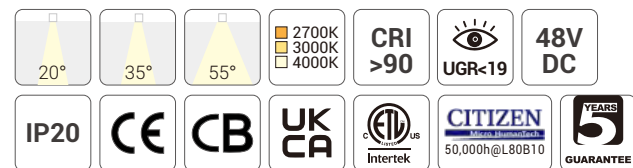

Quick Info

- System: 19W, 26W, CRI>90
- CCT: 2700K, 3000K, 4000K Available as Standard
- Beam Angle: 20°, 35°, 55°
- Lumen Output: Up to 2600lm System Luminous Flux
- IP Class: IP20
- Versions: On-Off, 1-10V Dim, DALI Dim

Light Distribution

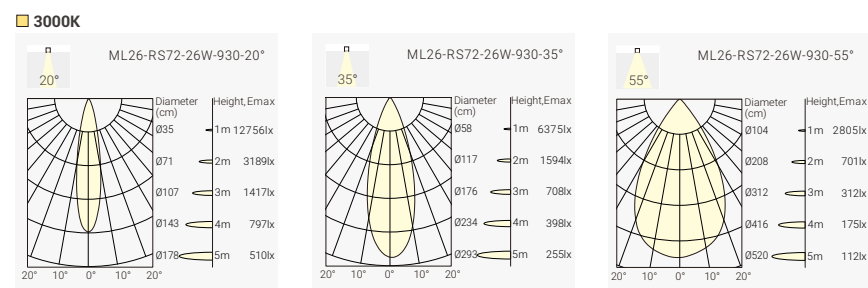

Finish



Order Info (ML26-RS72 in Black Hosing & Black Reflector as an Example)

LED Power	System Power	LED Voltage	CRI	CCT	Beam	LED Output	System Output	Code						
18W	19W	48V	90	2700K	20°	1800lm	1500lm	MLR7-9272019F-BB						
					35°	1800lm	1600lm	MLR7-9273519F-BB						
					55°	1800lm	1600lm	MLR7-9275519F-BB						
					3000K	20°	1900lm	1600lm	MLR7-9302019F-BB					
						35°	1900lm	1700lm	MLR7-9303519F-BB					
						55°	1900lm	1700lm	MLR7-9305519F-BB					
					4000K	20°	2100lm	1700lm	MLR7-9402019F-BB					
						35°	2100lm	1800lm	MLR7-9403519F-BB					
						55°	2100lm	1800lm	MLR7-9405519F-BB					
						25W	26W	48V	90	2700K	20°	2500lm	2100lm	MLR7-9272026F-BB
											35°	2500lm	2300lm	MLR7-9273526F-BB
											55°	2500lm	2300lm	MLR7-9275526F-BB
3000K	20°	2700lm	2200lm	MLR7-9302026F-BB										
	35°	2700lm	2400lm	MLR7-9303526F-BB										
	55°	2700lm	2400lm	MLR7-9305526F-BB										
4000K	20°	2900lm	2400lm	MLR7-9402026F-BB										
	35°	2900lm	2600lm	MLR7-9403526F-BB										
	55°	2900lm	2600lm	MLR7-9405526F-BB										

Code Remark: F=F(ON-OFF) A=A(1-10V Dim) D=D(DALI Dim)

Coding

Model	CRI/ CCT	Beam Angle	Power	Control	Finish	Reflector Color	Accessory
MLR7 ML26-RS72-19W	927 CRI>90/ 2700K	20°	19W	F On-Off	W White	B Black	
MLR7 ML26-RS72-26W	930 CRI>90/ 3000K	35°	26W	A 1-10V Dim	B Black		
	940 CRI>90/ 4000K	55°		D DALI Dim			

Optional accessory

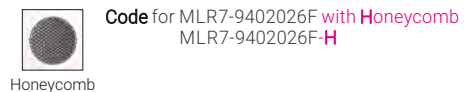

MODULINE 26 – ML26-RS96 Spotlight Inset



Quick Info

- System: 9W, CRI>90
- CCT: 2700K, 3000K, 4000K Available as Standard
- Beam Angle: 15°, 25°, 35°
- Lumen Output: Up to 830lm System Luminous Flux
- IP Class: IP20
- Versions: On-Off, 1-10V Dim, DALI Dim

Light Distribution

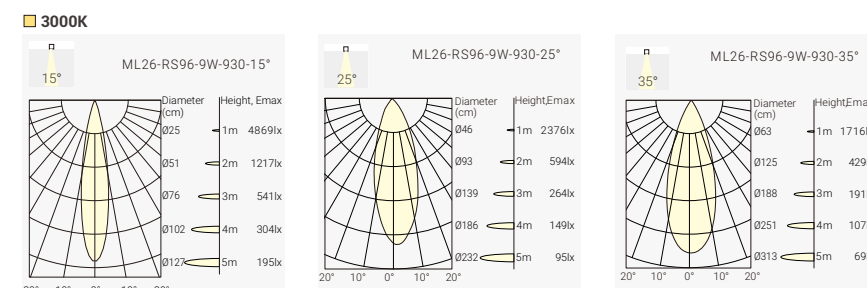

Finish



Order Info (ML26-RS96 in Black Hosing as an Example)

LED Power	System Power	LED Voltage	CRI	CCT	Beam	LED Output	System Output	Code	
8W	9W	48V	90	2700K	15°	900lm	700lm	MLR9-9271509N-BN	
					25°	900lm	720lm	MLR9-9272509N-BN	
					35°	900lm	720lm	MLR9-9273509N-BN	
					3000K	15°	950lm	720lm	MLR9-9301509N-BN
						25°	950lm	750lm	MLR9-9302509N-BN
						35°	950lm	750lm	MLR9-9303509N-BN
					4000K	15°	1050lm	780lm	MLR9-9401509N-BN
						25°	1050lm	830lm	MLR9-9402509N-BN
						35°	1050lm	830lm	MLR9-9403509N-BN

Code Remark: F=F(ON-OFF) A=A(1-10V Dim) D=D(DALI Dim)

Coding

Model	CRI/ CCT	Beam Angle	Power	Control	Finish	Reflector Color	Accessory
MLR9 ML26-RS96-9W	927 CRI>90/ 2700K	15°	09 9W	F On-Off	W White	N None	
	930 CRI>90/ 3000K	25°		A 1-10V Dim	B Black		
		35°		D DALI Dim			

MODULINE 26 – 48V Low Voltage Modular Linear System

ML26-FRS72 Spotlight Inset



Accessory

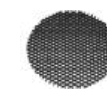

Honeycomb

Reflector



Black



White



Dark Light



Specular



Matt

MODULINE 26 – ML26-FRS72 Spotlight Inset

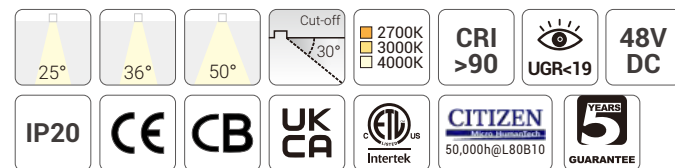

Quick Info

- System: 10W, CRI>90
- CCT: 2700K, 3000K, 4000K Available as Standard
- Beam Angle: 25°, 36°, 50°
- Lumen Output: Up to 780lm System Luminous Flux
- IP Class: IP20
- Versions: On-Off, 1-10V Dim, DALI Dim

Light Distribution

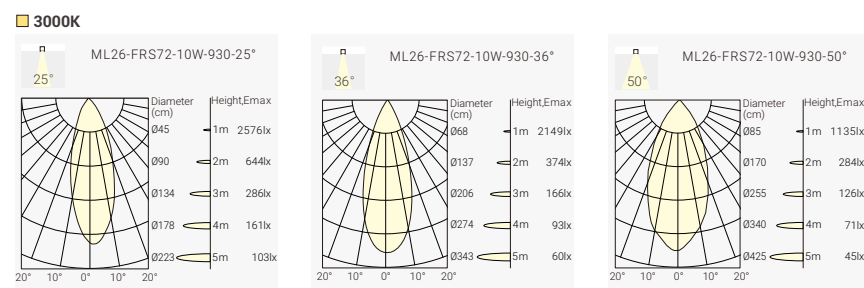
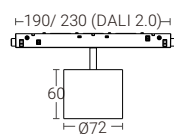

Finish



Order Info (ML26-FRS72 in Black Hosing & Dark Light Reflector as an Example)

LED Power	System Power	LED Voltage	CRI	CCT	Beam	LED Output	System Output	Code
9W	10W	48V	90	2700K	25°	900lm	620lm	MLF1-9272510F-BC
				3000K	36°	900lm	650lm	MLF1-9273610F-BC
				4000K	50°	1050lm	780lm	MLF1-9402510F-BC
				3000K	36°	950lm	700lm	MLF1-9303610F-BC
				4000K	50°	950lm	700lm	MLF1-9403610F-BC
				3000K	36°	950lm	700lm	MLF1-9305010F-BC
				4000K	50°	1050lm	780lm	MLF1-9405010F-BC

Code Remark: F=F(ON-OFF) A=A(1-10V Dim) D=D(DALI Dim)

Reflector Options

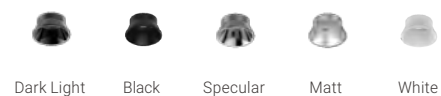

Optional accessory



Coding

MLF1 - *** ** ** * - * * - *

Model	CRI/ CCT	Beam Angle	Power	Control	Finish	Reflector Color	Accessory
MLF1 ML26-FRS72-10W Single Spot	927 CRI>90/ 2700K	25°	10 10W	F On-Off	W White	W White	H Honeycomb
	930 CRI>90/ 3000K	36°		A 1-10V Dim	B Black	B Black	
	940 CRI>90/ 4000K	50°		D DALI Dim	Z Brushed Bronze	S Specular	
					G Brushed Gold	C Dark Light	
						M Matt	

MODULINE 26 – ML26-FRS72 Double Spotlight Inset

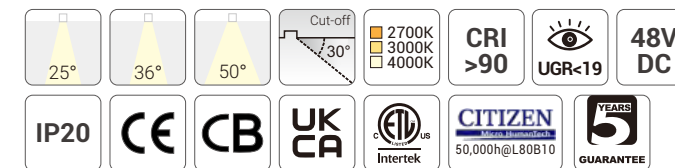

Quick Info

- System: 20W, CRI>90
- CCT: 2700K, 3000K, 4000K Available as Standard
- Beam Angle: 25°, 36°, 50°
- Lumen Output: Up to 1550lm System Luminous Flux
- IP Class: IP20
- Versions: On-Off, 1-10V Dim, DALI Dim

Light Distribution

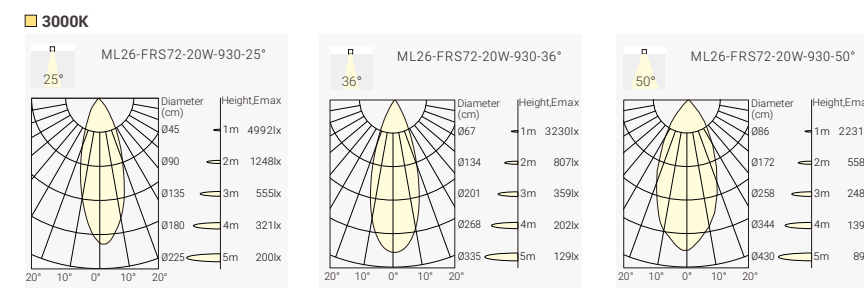
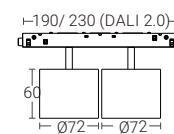

Finish



Order Info (ML26-FRS72 in Black Hosing & Dark Light Reflector as an Example)

LED Power	System Power	LED Voltage	CRI	CCT	Beam	LED Output	System Output	Code
18W	20W	48V	90	2700K	25°	1800lm	1250lm	MLF2-9272520F-BC
				3000K	36°	1800lm	1300lm	MLF2-9273620F-BC
				4000K	50°	2100lm	1400lm	MLF2-9402520F-BC
				3000K	36°	1900lm	1300lm	MLF2-9303620F-BC
				4000K	50°	1900lm	1400lm	MLF2-9403620F-BC
				3000K	36°	1900lm	1400lm	MLF2-9305020F-BC
				4000K	50°	2100lm	1550lm	MLF2-9405020F-BC

Code Remark: F=F(ON-OFF) A=A(1-10V Dim) D=D(DALI Dim)

Reflector Options

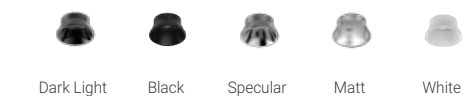

Optional accessory



Coding

MLF2 - *** ** ** * - * * - *

Model	CRI/ CCT	Beam Angle	Power	Control	Finish	Reflector Color	Accessory
MLF2 ML26-FRS72-20W Double Spot	927 CRI>90/ 2700K	25°	20 20W	F On-Off	W White	W White	H Honeycomb
	930 CRI>90/ 3000K	36°		A 1-10V Dim	B Black	B Black	
	940 CRI>90/ 4000K	50°		D DALI Dim	Z Brushed Bronze	S Specular	
					G Brushed Gold	C Dark Light	
						M Matt	

MODULINE 26 – ML26-FRD80 Round Downlight Inset

NEW



ML26-FRD80-10W



Quick Info

- System: 10W, CRI>90
- CCT: 2700K, 3000K, 4000K Available as Standard
- Beam Angle: 30°
- Lumen Output: Up to 1000lm System Luminous Flux
- IP Class: IP20
- LED Driver: On-Off, 1-10V Dim, DALI Dim
- Can only fit with MODULINE 26 Slim Track

Light Distribution

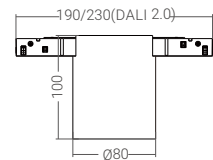
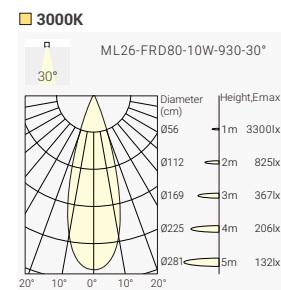

Finish



White



Black

Order Info (ML26-FRD80 in Black Hosing & Black Reflector as an Example)

LED Power	System Power	LED Voltage	CRI	CCT	Beam	LED Output	System Output	Code
9W	10W	48V	90	2700K	30°	1100lm	900lm	MLRD-9273010F-BB
				3000K	30°	1200lm	950lm	MLRD-9303010F-BB
				4000K	30°	1300lm	1000lm	MLRD-9403010F-BB

Code Remark: F=F(ON-OFF) A=A(1-10V Dim) D=D(DALI Dim)

Coding

Model	CRI/ CCT	Beam Angle	Power	Control	Finish	Reflector Color	Accessory
MLRD ML26-FRD80-10W	927 CRI>90/ 2700K	30°	10 10W	F On-Off	W White	W White	H Honeycomb
	930 CRI>90/ 3000K			A 1-10V Dim	B Black	B Black	
	940 CRI>90/ 4000K			D DALI Dim			

Optional accessory



Honeycomb

Code for MLRD-9303010F with Honeycomb
MLRD-9303010F-H

MODULINE 26 – ML26-FRDH80 Round Downlight Inset

NEW



ML26-FRDH80-10W



Quick Info

- System: 10W, CRI>90
- CCT: 2700K, 3000K, 4000K Available as Standard
- Beam Angle: 30°
- Lumen Output: Up to 1000lm System Luminous Flux
- IP Class: IP20
- LED Driver: On-Off, 1-10V Dim, DALI Dim
- Can only fit with MODULINE 26 Standard Track

Light Distribution

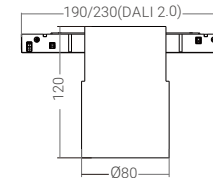
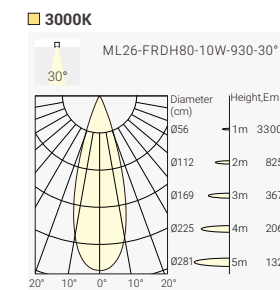

Finish



White



Black

Order Info (ML26-FRDH80 in Black Hosing & Black Reflector as an Example)

LED Power	System Power	LED Voltage	CRI	CCT	Beam	LED Output	System Output	Code
9W	10W	48V	90	2700K	30°	1100lm	900lm	MLRH-9273010F-BB
				3000K	30°	1200lm	950lm	MLRH-9303010F-BB
				4000K	30°	1300lm	1000lm	MLRH-9403010F-BB

Code Remark: F=F(ON-OFF) A=A(1-10V Dim) D=D(DALI Dim)

Coding

Model	CRI/ CCT	Beam Angle	Power	Control	Finish	Reflector Color	Accessory
MLRH ML26-FRDH80-10W	927 CRI>90/ 2700K	30°	10 10W	F On-Off	W White	W White	H Honeycomb
	930 CRI>90/ 3000K			A 1-10V Dim	B Black	B Black	
	940 CRI>90/ 4000K			D DALI Dim			

Optional accessory



Honeycomb

Code for MLRH-9303010F with Honeycomb
MLRH-9303010F-H

MODULINE 26 – ML26-FSD80 Square Downlight Inset

NEW



ML26-FSD80-10W



Quick Info

- System: 10W, CRI>90
- CCT: 2700K, 3000K, 4000K Available as Standard
- Beam Angle: 30°
- Lumen Output: Up to 1050lm System Luminous Flux
- IP Class: IP20
- LED Driver: On-Off, 1-10V Dim, DALI Dim
- Can only fit with MODULINE 26 Slim Track

Light Distribution

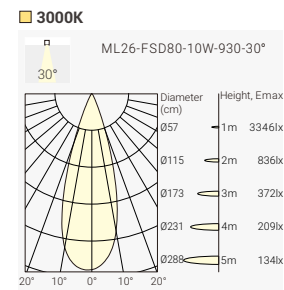
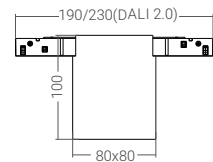

Finish



White

Black

Order Info (ML26-FSD80 in Black Hosing & Black Reflector as an Example)

LED Power	System Power	LED Voltage	CRI	CCT	Beam	LED Output	System Output	Code
9W	10W	48V	90	2700K	30°	1100lm	950lm	MLSD-9273010F-BB
				3000K	30°	1200lm	1000lm	MLSD-9303010F-BB
				4000K	30°	1300lm	1050lm	MLSD-9403010F-BB

Code Remark: F=F(ON-OFF) A=A(1-10V Dim) D=D(DALI Dim)

Coding

Model	CRI/ CCT	Beam Angle	Power	Control	Finish	Reflector Color	Accessory
MLSD ML26-FSD80-10W	927 CRI>90/ 2700K	30°	10 10W	F On-Off	W White	W White	H Honeycomb
	930 CRI>90/ 3000K			A 1-10V Dim	B Black	B Black	
	940 CRI>90/ 4000K			D DALI Dim			

Optional accessory



Honeycomb

Code for MLSD-9303010F-BB with Honeycomb
MLSD-9303010F-BB-H

MODULINE 26 – ML26-FSDH80 Square Downlight Inset

NEW



ML26-FSDH80-10W



Quick Info

- System: 10W, CRI>90
- CCT: 2700K, 3000K, 4000K Available as Standard
- Beam Angle: 30°
- Lumen Output: Up to 1050lm System Luminous Flux
- IP Class: IP20
- LED Driver: On-Off, 1-10V Dim, DALI Dim
- Can only fit with MODULINE 26 Standard Track

Light Distribution

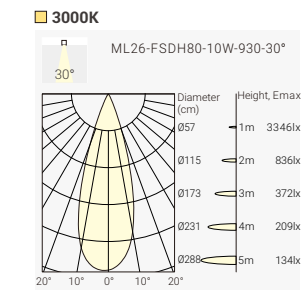
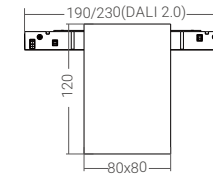

Finish



White

Black

Order Info (ML26-FSDH80 in Black Hosing & Black Reflector as an Example)

LED Power	System Power	LED Voltage	CRI	CCT	Beam	LED Output	System Output	Code
9W	10W	48V	90	2700K	30°	1100lm	950lm	MLSH-9273010F-BB
				3000K	30°	1200lm	1000lm	MLSH-9303010F-BB
				4000K	30°	1300lm	1050lm	MLSH-9403010F-BB

Code Remark: F=F(ON-OFF) A=A(1-10V Dim) D=D(DALI Dim)

Coding

Model	CRI/ CCT	Beam Angle	Power	Control	Finish	Reflector Color	Accessory
MLSH ML26-FSDH80-10W	927 CRI>90/ 2700K	30°	10 10W	F On-Off	W White	W White	H Honeycomb
	930 CRI>90/ 3000K			A 1-10V Dim	B Black	B Black	
	940 CRI>90/ 4000K			D DALI Dim			

Optional accessory



Honeycomb

Code for MSLH-9303010F-BB with Honeycomb
MSLH-9303010F-BB-H

MODULINE 26 – ML26-AL190 Accent Light Inset

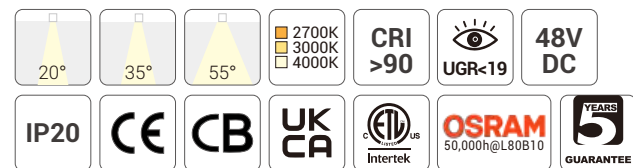

Quick Info

- System: 3W, 7W, CRI>90
- CCT: 2700K, 3000K, 4000K Available as Standard
- Beam Angle: 20°, 35°, 55°
- Lumen Output: Up to 600lm System Luminous Flux
- IP Class: IP20
- LED Driver: On-Off, 1-10V Dim, DALI Dim

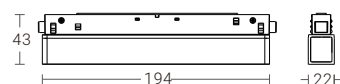

Light Distribution

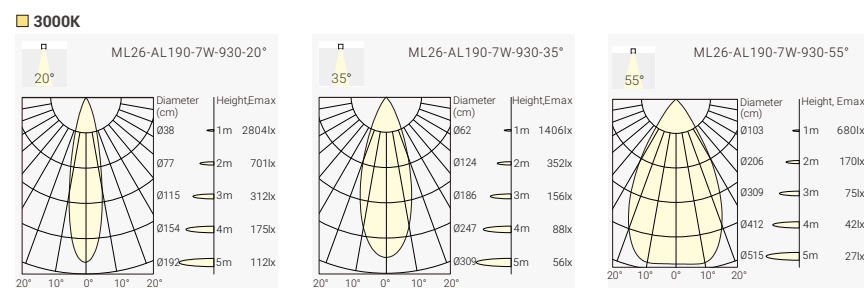

Finish

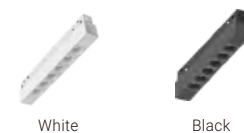

Order Info (ML26-AL190 in Black Hosing & Black Reflector as an Example)

LED Power	System Power	LED Voltage	CRI	CCT	Beam	LED Output	System Output	Code
2W	3W	48V	90	2700K	20°	230lm	170lm	MLA3-9272003F-BB
					35°	230lm	170lm	MLA3-9273503F-BB
					55°	230lm	160lm	MLA3-9275503F-BB
					20°	250lm	180lm	MLA3-9302003F-BB
					35°	250lm	180lm	MLA3-9303503F-BB
					55°	250lm	170lm	MLA3-9305503F-BB
					20°	270lm	200lm	MLA3-9402003F-BB
					35°	270lm	200lm	MLA3-9403503F-BB
					55°	270lm	190lm	MLA3-9405503F-BB
6W	7W	48V	90	2700K	20°	700lm	500lm	MLA4-9272007F-BB
					35°	700lm	500lm	MLA4-9273507F-BB
					55°	700lm	470lm	MLA4-9275507F-BB
					20°	750lm	550lm	MLA4-9302007F-BB
					35°	750lm	550lm	MLA4-9303507F-BB
					55°	750lm	500lm	MLA4-9305507F-BB
					20°	820lm	600lm	MLA4-9402007F-BB
					35°	820lm	600lm	MLA4-9403507F-BB
					55°	820lm	550lm	MLA4-9405507F-BB

Code Remark: F=F(ON-OFF) A=A(1-10V Dim) D=D(DALI Dim)

Coding

Model	CRI/ CCT	Beam Angle	Power	Control	Finish	Reflector Color	Accessory
MLA3 ML26-AL190-3W	927 CRI>90/ 2700K	20°	03 3W	F On-Off	W White	B Black	
MLA4 ML26-AL190-7W	930 CRI>90/ 3000K	35°	07 7W	A 1-10V Dim	B Black		
	940 CRI>90/ 4000K	55°		D DALI Dim			

MODULINE 26 – ML26-AL280 Accent Light Inset



Quick Info

- System: 9W, 13W, CRI>90
- CCT: 2700K, 3000K, 4000K Available as Standard
- Beam Angle: 20°, 35°, 55°
- Lumen Output: Up to 1200lm System Luminous Flux
- IP Class: IP20
- LED Driver: On-Off, 1-10V Dim, DALI Dim



Light Distribution

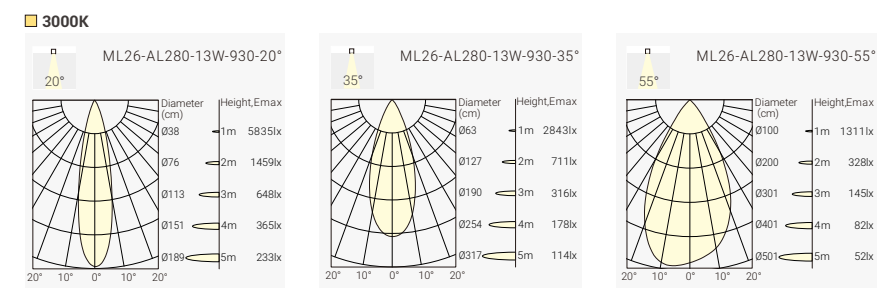

Finish



Order Info (ML26-AL280 in Black Hosing & Black Reflector as an Example)

LED Power	System Power	LED Voltage	CRI	CCT	Beam	LED Output	System Output	Code
8W	9W	48V	90	2700K	20°	950lm	700lm	MLA1-9272009F-BB
					35°	950lm	700lm	MLA1-9273509F-BB
					55°	950lm	650lm	MLA1-9275509F-BB
					20°	1000lm	750lm	MLA1-9302009F-BB
					35°	1000lm	750lm	MLA1-9303509F-BB
					55°	1000lm	680lm	MLA1-9305509F-BB
					20°	1100lm	800lm	MLA1-9402009F-BB
					35°	1100lm	800lm	MLA1-9403509F-BB
					55°	1100lm	750lm	MLA1-9405509F-BB
12W	13W	48V	90	2700K	20°	1400lm	1000lm	MLA2-9272013F-BB
					35°	1400lm	1000lm	MLA2-9273513F-BB
					55°	1400lm	950lm	MLA2-9275513F-BB
					20°	1500lm	1100lm	MLA2-9302013F-BB
					35°	1500lm	1100lm	MLA2-9303513F-BB
					55°	1500lm	1000lm	MLA2-9305513F-BB
					20°	1600lm	1200lm	MLA2-9402013F-BB
					35°	1600lm	1200lm	MLA2-9403513F-BB
					55°	1600lm	1100lm	MLA2-9405513F-BB

Code Remark: F=F(ON-OFF) A=A(1-10V Dim) D=D(DALI Dim)

Coding

Model	CRI/ CCT	Beam Angle	Power	Control	Finish	Reflector Color	Accessory
MLA1 ML26-AL280-9W	927 CRI>90/ 2700K	20°	09 9W	F On-Off	W White	B Black	
MLA2 ML26-AL280-13W	930 CRI>90/ 3000K	35°	13 13W	A 1-10V Dim	B Black		
	940 CRI>90/ 4000K	55°		D DALI Dim			

MODULINE 26 – ML26-AL560 Accent Light Inset

NEW



ML26-AL560-26W

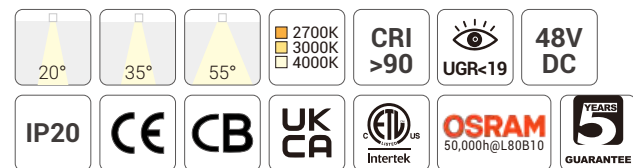

Quick Info

- System: 26W, CRI>90
- CCT: 2700K, 3000K, 4000K Available as Standard
- Beam Angle: 20°, 35°, 55°
- Lumen Output: Up to 2400lm System Luminous Flux
- IP Class: IP20
- LED Driver: On-Off, 1-10V Dim, DALI Dim



Light Distribution

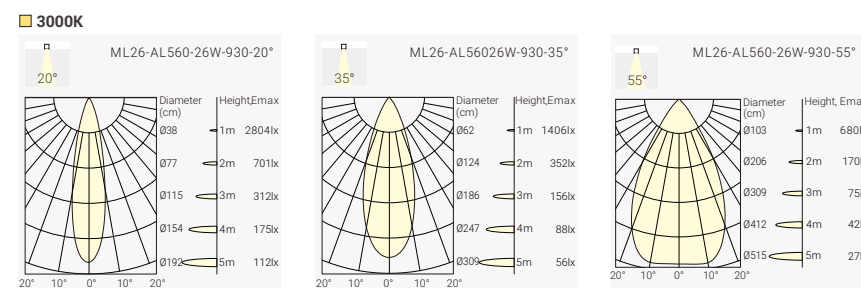

Finish



White

Black

Order Info (ML26-AL560 in Black Hosing & Black Reflector as an Example)

LED Power	System Power	LED Voltage	CRI	CCT	Beam	LED Output	System Output	Code
24W	26W	48V	90	2700K	20°	2800lm	2200lm	MLA6-9272026F-BB
					35°	2800lm	2350lm	MLA6-9273526F-BB
					55°	2800lm	1900lm	MLA6-9275526F-BB
			3000K		20°	3000lm	2300lm	MLA6-9302026F-BB
					35°	3000lm	2450lm	MLA6-9303526F-BB
					55°	3000lm	2000lm	MLA6-9305526F-BB
			4000K		20°	3200lm	2400lm	MLA6-9402026F-BB
					35°	3200lm	2550lm	MLA6-9403526F-BB
					55°	3200lm	2100lm	MLA6-9405526F-BB

Code Remark: F=F(ON-OFF) A=A(1-10V Dim) D=D(DALI Dim)

Coding

MLA6 - *** ** ** * - * * - *

Model	CRI/ CCT	Beam Angle	Power	Control	Finish	Reflector Color	Accessory
MLA6 ML26-AL560-26W	927 CRI>90/ 2700K	20°	26 26W	F On-Off	W White	B Black	
	930 CRI>90/ 3000K	35°		A 1-10V Dim	B Black		
	940 CRI>90/ 4000K	55°		D DALI Dim			



Project: 26-Pakubuwono Residence, Indonesia

MODULINE 26 – ML26-SA280 Adjustable Accent Light Inset



20° 35° 55°
2700K 3000K 4000K
CRI >90
UGR<19
48V DC

IP20 CE CB UK CA
Intertek OSRAM 50,000h@L80B10
5 YEARS GUARANTEE

Quick Info

- System: 13W, CRI>90
- CCT: 2700K, 3000K, 4000K Available as Standard
- Beam Angle: 20°, 35°, 55°
- Lumen Output: Up to 1200lm System Luminous Flux
- IP Class: IP20
- LED Driver: On-Off, 1-10V Dim, DALI Dim

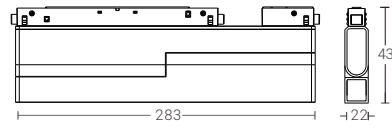

Light Distribution

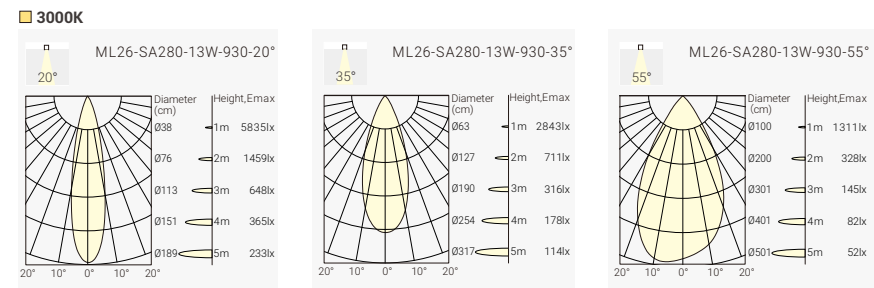

Finish

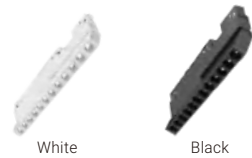

Order Info (ML26-SA280 in Black Hosing & Black Reflector as an Example)

LED Power	System Power	LED Voltage	CRI	CCT	Beam	LED Output	System Output	Code
12W	13W	48V	90	2700K	20°	1400lm	1000lm	MLA5-9272013F-BB
					35°	1400lm	1000lm	MLA5-9273513F-BB
					55°	1400lm	950lm	MLA5-9275513F-BB
			3000K	2700K	20°	1500lm	1000lm	MLA5-9302013F-BB
					35°	1500lm	1000lm	MLA5-9303513F-BB
					55°	1500lm	1100lm	MLA5-9305513F-BB
			4000K	2700K	20°	1600lm	1200lm	MLA5-9402013F-BB
					35°	1600lm	1200lm	MLA5-9403513F-BB
					55°	1600lm	1100lm	MLA5-9405513F-BB

Code Remark: F=F(ON-OFF) A=A(1-10V Dim) D=D(DALI Dim)

Coding

MLA5 - *** ** ** * - * * - *

Model	CRI/ CCT	Beam Angle	Power	Control	Finish	Reflector Color	Accessory
MLA5	927	20	13	F	W	B	
ML26-SA280-13W Adjustable Accent	CRI>90/ 2700K	20°	13W	On-Off	White	Black	
	930	35		A	B		
	CRI>90/ 3000K	35°		1-10V Dim	Black		
	940	55		D			
	CRI>90/ 4000K	55°		DALI Dim			

MODULINE 26 – ML26-SG280 Adjustable General Light Inset



110°
2700K 3000K 4000K
CRI >90
48V DC

IP20 CE CB UK CA
Intertek SAMSUNG 50,000h@L80B10
5 YEARS GUARANTEE

Quick Info

- System: 7W, CRI>90
- CCT: 2700K, 3000K, 4000K Available as Standard
- Beam Angle: 110°
- Lumen Output: Up to 450lm System Luminous Flux
- IP Class: IP20
- LED Driver: On-Off, 1-10V Dim, DALI Dim

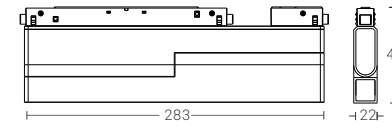

Light Distribution

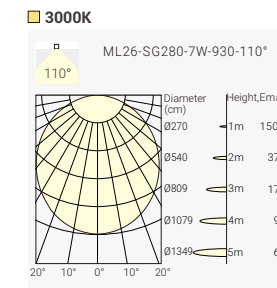

Finish

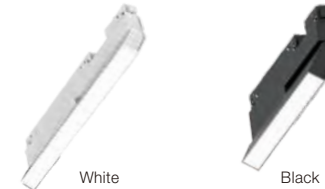

Order Info (ML26-SG280 in Black Hosing as an Example)

LED Power	System Power	LED Voltage	CRI	CCT	Beam	LED Output	System Output	Code
6W	7W	48V	90	2700K	110°	550lm	430lm	MLG5-927A107F-BN
					110°	600lm	400lm	MLG5-930A107F-BN
					110°	650lm	450lm	MLG5-940A107F-BN

Code Remark: F=F(ON-OFF) A=A(1-10V Dim) D=D(DALI Dim)

Coding

MLG5 - *** ** ** * - * * - *

Model	CRI/ CCT	Beam Angle	Power	Control	Finish	Reflector Color	Accessory
MLG5	927	A1	07	F	W	N	
ML26-SG280-7W General Light	CRI>90/ 2700K	110°	7W	On-Off	White	None	
	930			A	B		
	CRI>90/ 3000K			1-10V Dim	Black		
	940			D			
	CRI>90/ 4000K			DALI Dim			

MODULINE 26 – ML26-GL280 & ML26-GL560 General Light Inset



Quick Info

- System: 7W, 13W, CRI>90
- CCT: 2700K, 3000K, 4000K Available as Standard
- Beam Angle: 110°
- Lumen Output: Up to 450lm or 900lm System Luminous Flux
- IP Class: IP20
- LED Driver: On-Off, 1-10V Dim, DALI Dim

Light Distribution

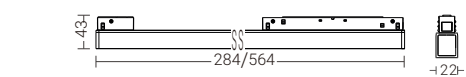
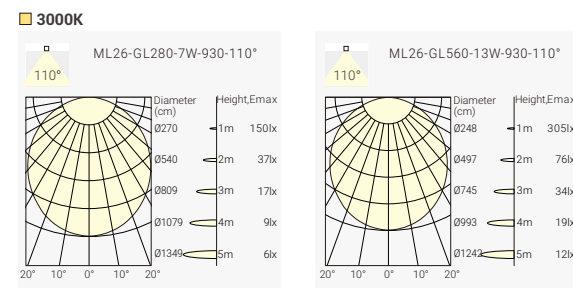

Finish



Order Info (ML26-GL280 & ML26-GL560 in Black Hosing as an Example)

LED Power	System Power	LED Voltage	CRI	CCT	Beam	LED Output	System Output	Code
6W	7W	48V	90	2700K	110°	550lm	430lm	MLG1-927A107F-BN
				3000K	110°	600lm	400lm	MLG1-927A107F-BN
				4000K	110°	650lm	450lm	MLG1-927A107F-BN
12W	13W	48V	90	2700K	110°	1100lm	750lm	MLG2-927A113F-BN
				3000K	110°	1200lm	800lm	MLG2-927A113F-BN
				4000K	110°	1300lm	900lm	MLG2-927A113F-BN

Code Remark: F=F(ON-OFF) A=A(1-10V Dim) D=D(DALI Dim)

Coding

Model	CRI/ CCT	Beam Angle	Power	Control	Finish	Reflector Color	Accessory
MLG1 ML26-GL280-7W General Light	927 CRI>90/ 2700K	A1 110°	07 7W	F On-Off	W White	N None	
MLG2 ML26-GL560-13W General Light	930 CRI>90/ 3000K		13 13W	A 1-10V Dim	B Black		
	940 CRI>90/ 4000K			D DALI Dim			

MODULINE 26 – ML26-GL840 & ML26-GL1120 General Light Inset



Quick Info

- System: 19W, 26W, CRI>90
- CCT: 2700K, 3000K, 4000K Available as Standard
- Beam Angle: 110°
- Lumen Output: Up to 1300lm or 1700lm System Luminous Flux
- IP Class: IP20
- LED Driver: On-Off, 1-10V Dim, DALI Dim

Light Distribution

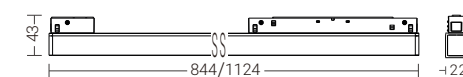
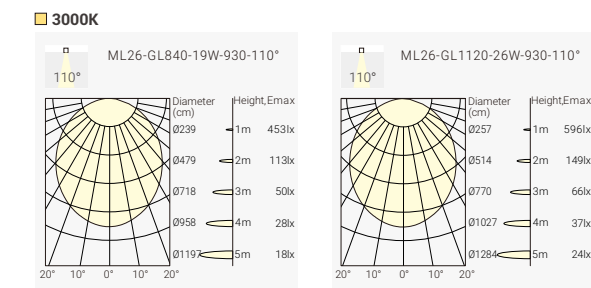

Finish



Order Info (ML26-GL840 & ML26-GL1120 in Black Hosing as an Example)

LED Power	System Power	LED Voltage	CRI	CCT	Beam	LED Output	System Output	Code
18W	19W	48V	90	2700K	110°	1700lm	1100lm	MLG3-927A119F-BN
				3000K	110°	1800lm	1200lm	MLG3-927A119F-BN
				4000K	110°	1900lm	1300lm	MLG3-927A119F-BN
24W	26W	48V	90	2700K	110°	2200lm	1500lm	MLG4-927A126F-BN
				3000K	110°	2400lm	1600lm	MLG4-927A126F-BN
				4000K	110°	2600lm	1700lm	MLG4-927A126F-BN

Code Remark: F=F(ON-OFF) A=A(1-10V Dim) D=D(DALI Dim)

Coding

Model	CRI/ CCT	Beam Angle	Power	Control	Finish	Reflector Color	Accessory
MLG3 ML26-GL840-19W General Light	927 CRI>90/ 2700K	A1 110°	19 19W	F On-Off	W White	N None	
MLG4 ML26-GL1120-26W General Light	930 CRI>90/ 3000K		26 26W	A 1-10V Dim	B Black		
	940 CRI>90/ 4000K			D DALI Dim			

MODULINE 26 – ML26-CL280 & ML26-CL560 General Light Inset

NEW



ML26-CL280-7W



ML26-CL560-13W



Quick Info

- System: 7W, 13W, CRI>90
- CCT: 2700K, 3000K, 4000K Available as Standard
- Beam Angle: 65° (Microprismatic Cover Version)
- Lumen Output: Up to 420lm or 800lm System Luminous Flux
- IP Class: IP20
- LED Driver: On-Off, 1-10V Dim, DALI Dim

Light Distribution

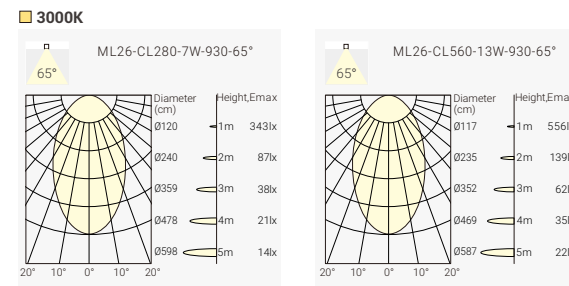

Finish

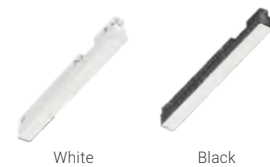

Order Info (ML26-CL280 & ML26-CL560 in Black Hosing as an Example)

LED Power	System Power	LED Voltage	CRI	CCT	Beam	LED Output	System Output	Code
6W	7W	48V	90	2700K	65°	550lm	360lm	MLC1-9276507F-BN
				3000K	65°	600lm	380lm	MLC1-9276507F-BN
				4000K	65°	650lm	420lm	MLC1-9276507F-BN
12W	13W	48V	90	2700K	65°	1100lm	720lm	MLC2-9276513F-BN
				3000K	65°	1200lm	750lm	MLC2-9276513F-BN
				4000K	65°	1300lm	800lm	MLC2-9276513F-BN

Code Remark: F=F(ON-OFF) A=A(1-10V Dim) D=D(DALI Dim)

Coding

Model	CRI/ CCT	Beam Angle	Power	Control	Finish	Reflector Color	Accessory
MLC1 ML26-CL280-7W General Light	927 CRI>90/ 2700K	65 65° Microprismatic Cover Version	07 7W	F On-Off	W White	N None	
MLC2 ML26-CL560-13W General Light	930 CRI>90/ 3000K	13 13W	A 1-10V Dim	B Black			
	940 CRI>90/ 4000K		D DALI Dim				

MODULINE 26 – ML26-CL840 & ML26-CL1120 General Light Inset

NEW



ML26-CL840-19W



ML26-CL1120-26W



Quick Info

- System: 19W, 26W, CRI>90
- CCT: 2700K, 3000K, 4000K Available as Standard
- Beam Angle: 65° (Microprismatic Cover Version)
- Lumen Output: Up to 1200lm or 1600lm System Luminous Flux
- IP Class: IP20
- LED Driver: On-Off, 1-10V Dim, DALI Dim

Light Distribution

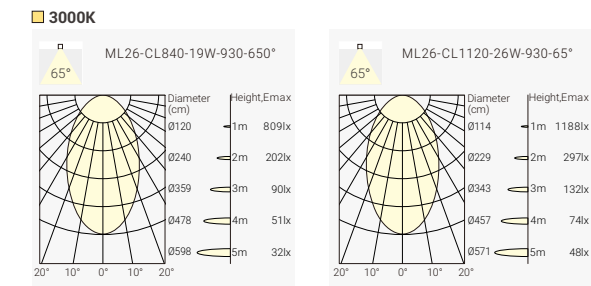

Finish



Order Info (ML26-CL840 & ML26-CL1120 in Black Hosing as an Example)

LED Power	System Power	LED Voltage	CRI	CCT	Beam	LED Output	System Output	Code
18W	19W	48V	90	2700K	65°	1700lm	1000lm	MLC3-9276519F-BN
				3000K	65°	1800lm	1100lm	MLC3-9276519F-BN
				4000K	65°	1900lm	1200lm	MLC3-9276519F-BN
24W	26W	48V	90	2700K	65°	2200lm	1400lm	MLC4-9276526F-BN
				3000K	65°	2400lm	1500lm	MLC4-9276526F-BN
				4000K	65°	2600lm	1600lm	MLC4-9276526F-BN

Code Remark: F=F(ON-OFF) A=A(1-10V Dim) D=D(DALI Dim)

Coding

Model	CRI/ CCT	Beam Angle	Power	Control	Finish	Reflector Color	Accessory
MLC3 ML26-CL840-19W General Light	927 CRI>90/ 2700K	65 65° Microprismatic Cover Version	19 19W	F On-Off	W White	N None	
MLC4 ML26-CL1120-26W General Light	930 CRI>90/ 3000K	26 26W	A 1-10V Dim	B Black			
	940 CRI>90/ 4000K		D DALI Dim				

MODULINE 26 – ML26-RB120 & ML26-RB150 Pendant Light Inset

NEW

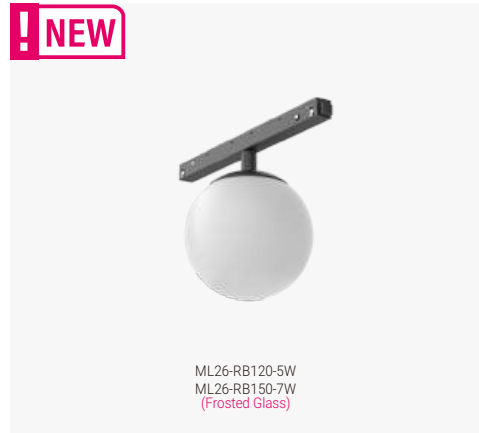

Quick Info

- System: 5W, 7W, CRI>90
- CCT: 2700K, 3000K, 4000K Available as Standard
- Beam Angle: 300°
- Lumen Output: Up to 470lm or 550lm System Luminous Flux
- IP Class: IP20
- LED Driver: On-Off, 1-10V Dim, DALI Dim

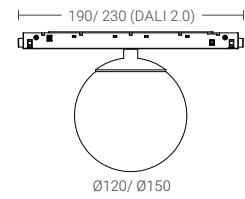

Light Distribution

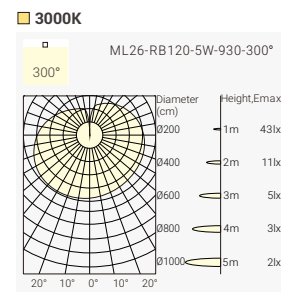

Finish



Order Info (ML26-PB120 in Black Hosing as an Example)

LED Power	System Power	LED Voltage	CRI	CCT	Beam	LED Output	System Output	Code
4W	5W	48V	90	2700K	300°	500lm	400lm	MLRB-927C005F-BN
				3000K	300°	550lm	430lm	MLRB-930C005F-BN
				4000K	300°	600lm	470lm	MLRB-940C005F-BN
6W	7W	48V	90	2700K	300°	600lm	470lm	MLRB-927C007F-BN
				3000K	300°	650lm	500lm	MLRB-930C007F-BN
				4000K	300°	550lm	550lm	MLRB-940C007F-BN

Code Remark: F=F (ON-OFF) A=A (1-10V Dim) D=D (DALI Dim)

Coding

Model	CRI/ CCT	Beam Angle	Power	Control	Finish	Reflector Color	Accessory
MLRB ML26-RB120-5W Pendant Spot	927 CRI>90/ 2700K	C0 300°	05 5W	F On-Off	W White	N None	
MLRB ML26-RB150-7W Pendant Spot	930 CRI>90/ 3000K		07 7W	A 1-10V Dim	B Black		
	940 CRI>90/ 4000K			D DALI Dim			

MODULINE 26 – ML26-PB120 & ML26-PB150 Decorative Ball Inset

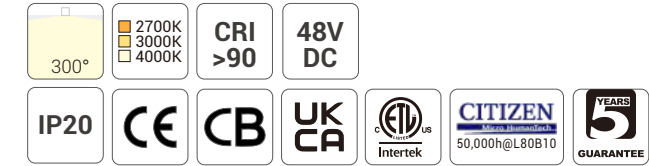

Quick Info

- System: 5W, 7W, CRI>90
- CCT: 2700K, 3000K, 4000K Available as Standard
- Beam Angle: 300°
- Lumen Output: Up to 470lm or 550lm System Luminous Flux
- IP Class: IP20
- LED Driver: On-Off, 1-10V Dim, DALI Dim

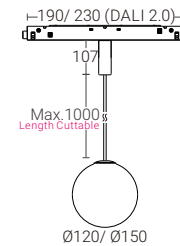

Light Distribution

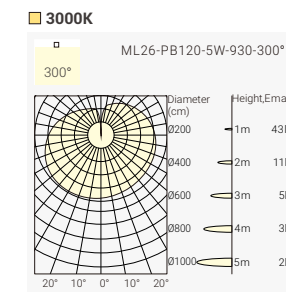

Finish



Order Info (ML26-PB120 & ML26-PB150 in Black Hosing as an Example)

LED Power	System Power	LED Voltage	CRI	CCT	Beam	LED Output	System Output	Code
4W	5W	48V	90	2700K	300°	500lm	400lm	MLPB-927C005F-BN
				3000K	300°	550lm	430lm	MLPB-930C005F-BN
				4000K	300°	600lm	470lm	MLPB-940C005F-BN
6W	7W	48V	90	2700K	300°	600lm	470lm	MLPB-927C007F-BN
				3000K	300°	650lm	500lm	MLPB-930C007F-BN
				4000K	300°	550lm	550lm	MLPB-940C007F-BN

Code Remark: F=F (ON-OFF) A=A (1-10V Dim) D=D (DALI Dim)

Coding

Model	CRI/ CCT	Beam Angle	Power	Control	Finish	Reflector Color	Accessory
MLPB ML26-PB120-5W	927 CRI>90/ 2700K	C0 300°	05 5W	F On-Off	W White	N None	
MLPB ML26-PB150-7W	930 CRI>90/ 3000K		07 7W	A 1-10V Dim	B Black		
	940 CRI>90/ 4000K			D DALI Dim			

MODULINE 26 – ML26-PS40 Pendant Spot Inset



Quick Info

- System: 12W, CRI>90
- CCT: 2700K, 3000K, 4000K Available as Standard
- Beam Angle: 18°, 30°, 45°
- Lumen Output: Up to 800lm System Luminous Flux
- IP Class: IP20
- LED Driver: On-Off, 1-10V Dim, DALI Dim

Light Distribution

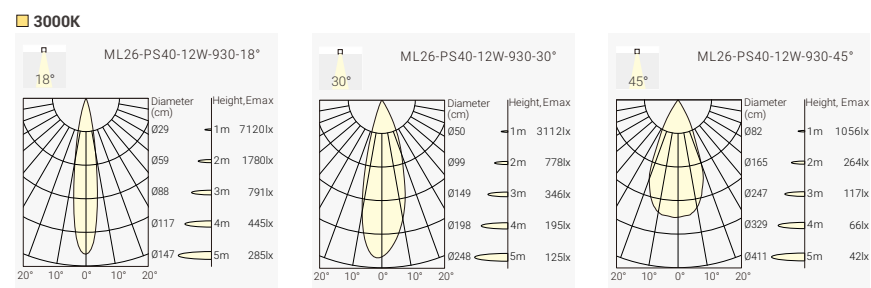

Finish



Order Info (ML26-PS40 in Black Hosing & Black Reflector as an Example)

LED Power	System Power	LED Voltage	CRI	CCT	Beam	LED Output	System Output	Code
11W	12W	48V	90	2700K	18°	1000lm	700lm	MLP1-9271812F-BB
					30°	1000lm	700lm	MLP1-9273012F-BB
					45°	1000lm	550lm	MLP1-9274512F-BB
				3000K	18°	1100lm	750lm	MLP1-9301812F-BB
					30°	1100lm	750lm	MLP1-9303012F-BB
					45°	1100lm	600lm	MLP1-9304512F-BB
				4000K	18°	1200lm	800lm	MLP1-9401812F-BB
					30°	1200lm	800lm	MLP1-9403012F-BB
					45°	1200lm	650lm	MLP1-9404512F-BB

Code Remark: F=F(ON-OFF) A=A(1-10V Dim) D=D(DALI Dim)

Coding

Model	CRI/ CCT	Beam Angle	Power	Control	Finish	Reflector Color	Accessory
MLP1 ML26-PS40-12W Pendant Spot	927 CRI>90/ 2700K	18°	12 12W	F On-Off	W White	B Black	H Honeycomb
	930 CRI>90/ 3000K	30°		A 1-10V Dim	B Black		
	940 CRI>90/ 4000K	45°		D DALI Dim	Z Brushed Bronze		
					G Brushed Gold		

Optional accessory

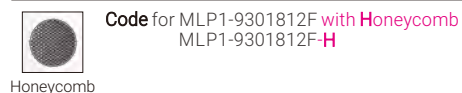

MODULINE 26 – ML26-PS55 Pendant Spot Inset

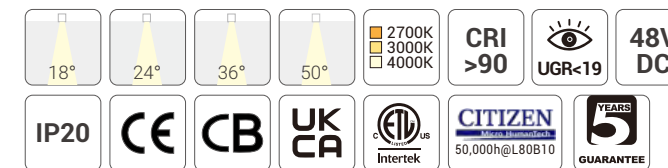

Quick Info

- System: 10W, CRI>90
- CCT: 2700K, 3000K, 4000K Available as Standard
- Beam Angle: 18°, 24°, 36°, 50°
- Lumen Output: Up to 870lm System Luminous Flux
- IP Class: IP20
- LED Driver: On-Off, 1-10V Dim, DALI Dim

Light Distribution

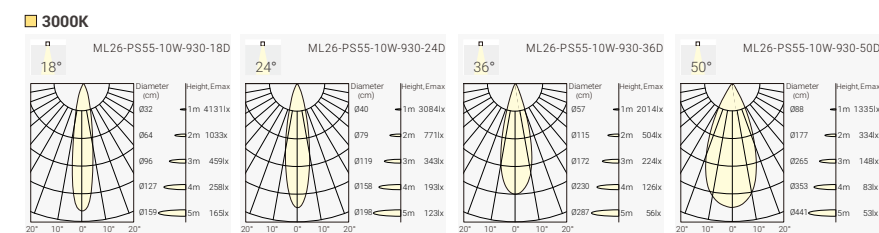

Finish



Order Info (ML26-PS55 in Black Hosing & Black Reflector as an Example)

LED Power	System Power	LED Voltage	CRI	CCT	Beam	LED Output	System Output	Code
9W	10W	48V	90	2700K	18°	850lm	620lm	MLP4-9271810F-BB
					24°	850lm	620lm	MLP4-9272410F-BB
					36°	850lm	620lm	MLP4-9273610F-BB
					50°	850lm	700lm	MLP4-9275010F-BB
				3000K	18°	950lm	650lm	MLP4-9301810F-BB
					24°	950lm	650lm	MLP4-9302410F-BB
					36°	950lm	650lm	MLP4-9303610F-BB
					50°	950lm	800lm	MLP4-9305010F-BB
				4000K	18°	1000lm	700lm	MLP4-9401810F-BB
					24°	1000lm	700lm	MLP4-9402410F-BB
					36°	1000lm	700lm	MLP4-9403610F-BB
					50°	1000lm	870lm	MLP4-9405010F-BB

Code Remark: F=F(ON-OFF) A=A(1-10V Dim) D=D(DALI Dim)

Coding

Model	CRI/ CCT	Beam Angle	Power	Control	Finish	Reflector Color	Accessory
MLP4 ML26-PS40-10W Pendant Spot	927 CRI>90/ 2700K	18°	10 10W	F On-Off	W White	B Black	H Honeycomb
	930 CRI>90/ 3000K	30°		A 1-10V Dim	B Black		
	940 CRI>90/ 4000K	45°		D DALI Dim	Z Brushed Bronze		
		50°			G Brushed Gold		

Optional accessory

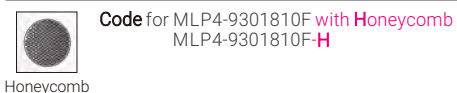

MODULINE 26 – ML26-PS60 Pendant Light Inset

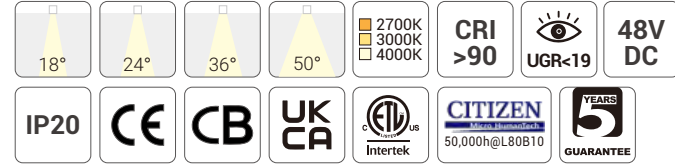

Quick Info

- System: 5W, CRI>90
- CCT: 2700K, 3000K, 4000K Available as Standard
- Beam Angle: 18°, 24°, 36°, 50°
- Lumen Output: Up to 450lm System Luminous Flux
- IP Class: IP20
- LED Driver: On-Off, 1-10V Dim, DALI Dim

Light Distribution

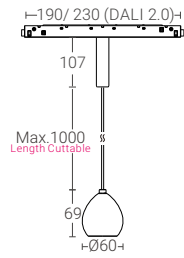
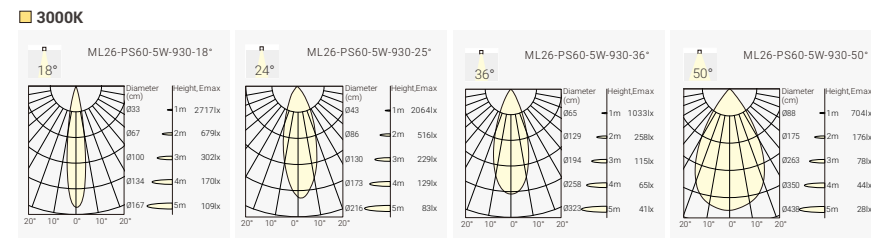

Finish



Order Info (ML26-PS60 in Black Hosing & Black Reflector as an Example)

LED Power	System Power	LED Voltage	CRI	CCT	Beam	LED Output	System Output	Code
4.5W	5W	48V	90	2700K	18°	370lm	370lm	MLP3-9271805F-BB
					24°	370lm	370lm	MLP3-9272405F-BB
					36°	370lm	370lm	MLP3-9273605F-BB
					50°	370lm	370lm	MLP3-9275005F-BB
			3000K	18°	500lm	400lm	400lm	MLP3-9301805F-BB
				24°	500lm	400lm	400lm	MLP3-9302405F-BB
				36°	500lm	400lm	400lm	MLP3-9303605F-BB
				50°	500lm	400lm	400lm	MLP3-9305005F-BB
			4000K	18°	550lm	450lm	450lm	MLP3-9401805F-BB
				24°	550lm	450lm	450lm	MLP3-9402405F-BB
				36°	550lm	450lm	450lm	MLP3-9403605F-BB
				50°	550lm	450lm	450lm	MLP3-9405005F-BB

Code Remark: F=F(ON-OFF) A=A(1-10V Dim) D=D(DALI Dim)

Coding

Model	CRI/ CCT	Beam Angle	Power	Control	Finish	Reflector Color	Accessory
MLP3	927	18	05	F	W	B	
ML26-PS60-5W	CRI>90/ 2700K	18°	5W	On-Off	White	Black	
Pendant Spot	930	24		A	B		
	CRI>90/ 3000K	24°		1-10V Dim	Black		
	940	36		D			
	CRI>90/ 4000K	36°		DALI Dim			
		50					
		50°					

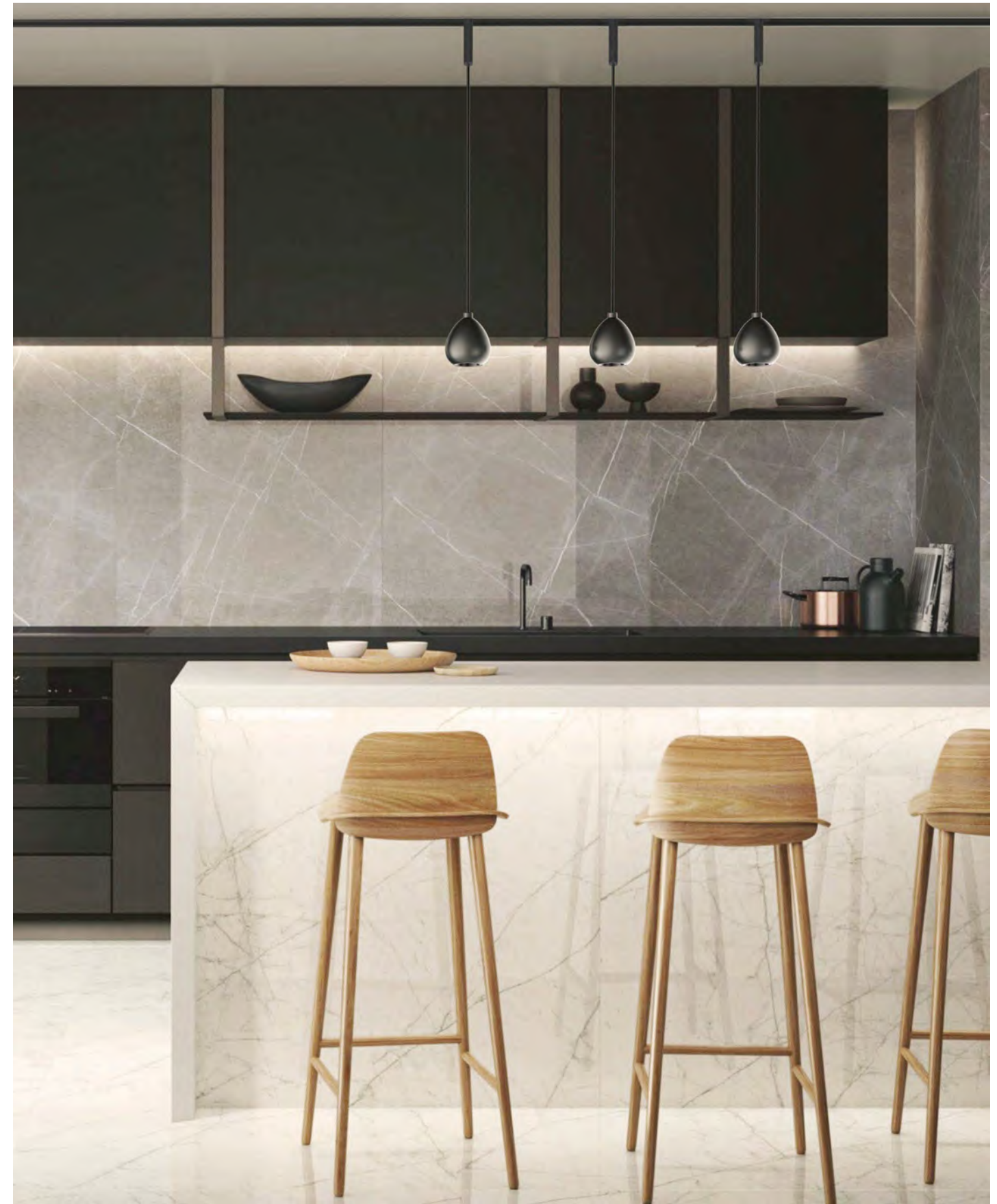

MODULINE 26 – ML26-WW280 & ML26-WW560 Wall Washer Inset



Quick Info

- System: 7W, 13W, CRI>90
- CCT: 2700K, 3000K, 4000K Available as Standard
- Beam Angle: Wall Washer
- Lumen Output: Up to 450lm or 750lm System Luminous Flux
- IP Class: IP20
- LED Driver: On-Off, 1-10V Dim, DALI Dim

Light Distribution

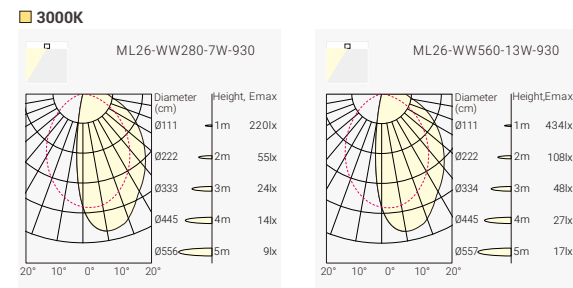

Finish



Order Info (ML26-WW280 & WW560 in Black Hosing & Matt Reflector as an Example)

LED Power	System Power	LED Voltage	CRI	CCT	Beam	LED Output	System Output	Code
6W	7W	48V	90	2700K	WW	550lm	330lm	MLW1-927WW07F-BM
				3000K	WW	600lm	350lm	MLW1-930WW07F-BM
				4000K	WW	650lm	450lm	MLW1-940WW07F-BM
12W	13W	48V	90	2700K	WW	1100lm	670lm	MLW2-927WW13F-BM
				3000K	WW	1200lm	700lm	MLW2-930WW13F-BM
				4000K	WW	1300lm	750lm	MLW2-940WW13F-BM

Code Remark: F=F(ON-OFF) A=A(1-10V Dim) D=D(DALI Dim)

Coding

Model	CRI/ CCT	Beam Angle	Power	Control	Finish	Reflector Color	Accessory
MLW1 ML26-WW280-7W	927 CRI>90/ 2700K	WW Wall Washer	07 7W	F On-Off	W White	M Matt	
MLW2 ML26-WW560-13W	930 CRI>90/ 3000K		13 13W	A 1-10V Dim	B Black		
	940 CRI>90/ 4000K			D DALI Dim			

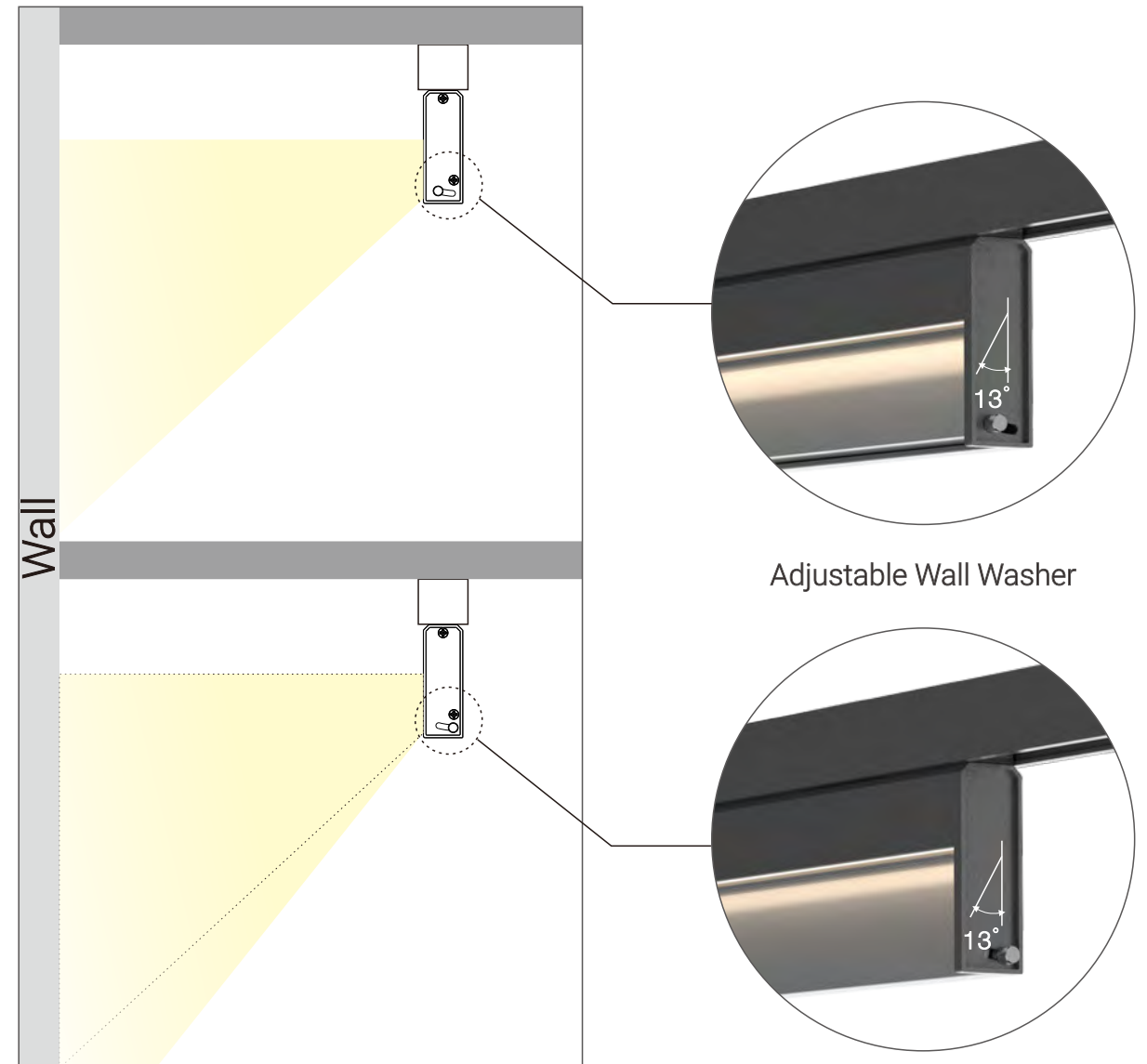

NEW



Quick Info

- System: 19W, CRI>90
- CCT: 3000K, 4000K Available as Standard
- Beam Angle: 360°
- Lumen Output: Up to 1400lm System Luminous Flux
- IP Class: IP20
- LED Driver: On-Off, 1-10V Dim, DALI Dim

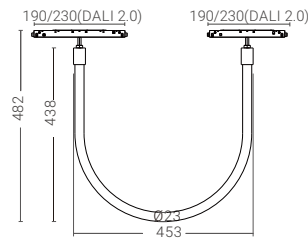

Light Distribution

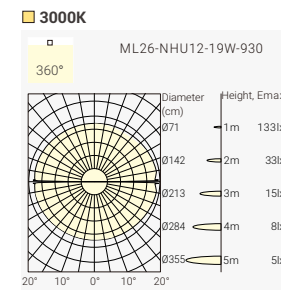

Finish



White



Black

Order Info (ML26-NHU12 in Black Hosing as an Example)

LED Power	System Power	LED Voltage	CRI	CCT	Beam	LED Output	System Output	Code
17W	19W	48V	90	3000K 4000K	360° 360°	2200lm 2400lm	1300lm 1400lm	MNHU-930C619F-BN MNHU-940C619F-BN

Code Remark: F=F(ON-OFF) A=A(1-10V Dim) D=D(DALI Dim)

Coding

MNHU - *** ** ** * - * * - *

Model	CRI/ CCT	Beam Angle	Power	Control	Finish	Reflector Color	Accessory
MNHU ML26-NHU12-19W Neon Strip	930 CRI>90/ 3000K	C6 360°	19 19W	F On-Off	W White	N None	
	940 CRI>90/ 4000K			A 1-10V Dim	B Black		
				D DALI Dim			



MODULINE 26 – ML26-NHP10 Neon Strip Inset



Quick Info

- System: 14W, CRI>90
- CCT: 3000K, 4000K Available as Standard
- Beam Angle: 360°
- Lumen Output: Up to 1050lm System Luminous Flux
- IP Class: IP20
- LED Driver: On-Off, 1-10V Dim, DALI Dim

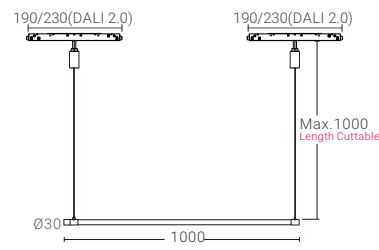

Light Distribution

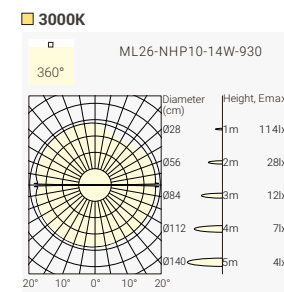

Finish



Order Info (ML26-NHP10 in Black Hosing as an Example)

LED Power	System Power	LED Voltage	CRI	CCT	Beam	LED Output	System Output	Code
13W	14W	48V	90	3000K 4000K	360° 360°	1600lm 1700lm	1000lm 1050lm	MNHP-930C614F-BN MNHP-940C614F-BN

Code Remark: F=F(ON-OFF) A=A(1-10V Dim) D=D(DALI Dim)

Coding

Model	CRI/ CCT	Beam Angle	Power	Control	Finish	Reflector Color	Accessory
MNHU ML26-NHU10-14W Neon Strip	930 CRI>90/ 3000K	C6 360°	19 19W	F On-Off	W White	N None	
	940 CRI>90/ 4000K			A 1-10V Dim	B Black		
				D DALI Dim			

MODULINE 26 – ML26-NVP12 Neon Strip Inset



Quick Info

- System: 19W, CRI>90
- CCT: 3000K, 4000K Available as Standard
- Beam Angle: 360°
- Lumen Output: Up to 1100lm System Luminous Flux
- IP Class: IP20
- LED Driver: On-Off, 1-10V Dim, DALI Dim

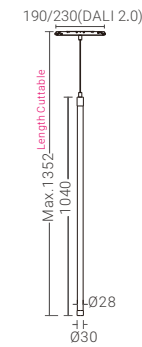

Light Distribution

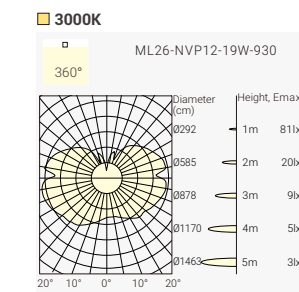

Finish

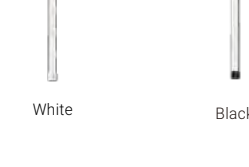

Order Info (ML26-NVP12 in Black Hosing as an Example)

LED Power	System Power	LED Voltage	CRI	CCT	Beam	LED Output	System Output	Code
17W	19W	48V	90	3000K 4000K	360° 360°	2200lm 2400lm	1050lm 1100lm	MNVP-930C619F-BN MNVP-940C619F-BN

Code Remark: F=F(ON-OFF) A=A(1-10V Dim) D=D(DALI Dim)

Coding

Model	CRI/ CCT	Beam Angle	Power	Control	Finish	Reflector Color	Accessory
MNVP ML26-NVP12-19W Neon Strip	930 CRI>90/ 3000K	C6 360°	19 19W	F On-Off	W White	N None	
	940 CRI>90/ 4000K			A 1-10V Dim	B Black		
				D DALI Dim			

GAME & SUGAR

The high-efficiency modern ceiling light series.

GAME: A classical flat design, available in white and black.

SUGAR: A decorative recessed frame design, available in white-gold and black-gold.

- Featuring a top-level micro-prismatic cover to enhance visual comfort (UGR<19) combined with homogeneous lighting.
- Four housing diameters available: Ø350, Ø450, Ø600, Ø900.
- Can be surface-mounted onto the ceiling, or pendant through wire or rod.
- An indirect light module is available as an option, easily mounted onto the luminaire.
- Light color temperature options: 3000K, 4000K, or Tunable White.
- Lumen efficiency up to 140 lm/W.
- Well-suited for offices, meeting rooms, schools, shops, and more



GAME

SUGAR

Microprismatic Cover

UGR<19

Up to 140lm/w



Magnetic Uplight Module



8W Up Light(250mA) 950lm
12W Down Light(350mA) 1800lm
16W Down Light(500mA) 2350lm
ON-OFF/Phase Dim/1-10V/DALI Dim

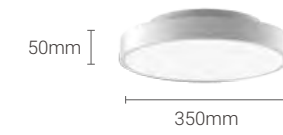

11W Up Light(350mA) 1200lm
16W Down Light(500mA) 2500lm
24W Down Light(700mA) 3400lm
ON-OFF/Phase Dim/1-10V/DALI Dim

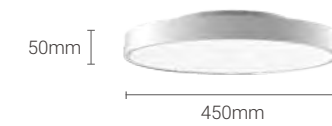

18W Up Light(500mA) 1800lm
24W Down Light(700mA) 3300lm
36W Down Light(1050mA) 5300lm
46W Down Light(1400mA) 6700lm
ON-OFF/Phase Dim/1-10V/DALI Dim

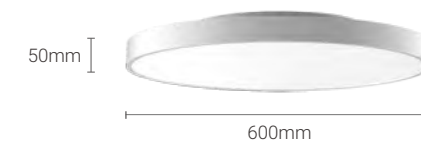

25W Up Light(700mA) 2700lm
65W Down Light(1400mA) 8700lm
ON-OFF/1-10V/DALI Dim



GAME

D1: GAME 350: D1=Ø350mm
GAME 450: D1=Ø450mm
GAME 600: D1=Ø600mm
GAME 900: D1=Ø900mm

D2: GAME 350/ 450: D2=Ø235mm
GAME 600/ 900: D2=Ø350mm

D3: Ø136mm

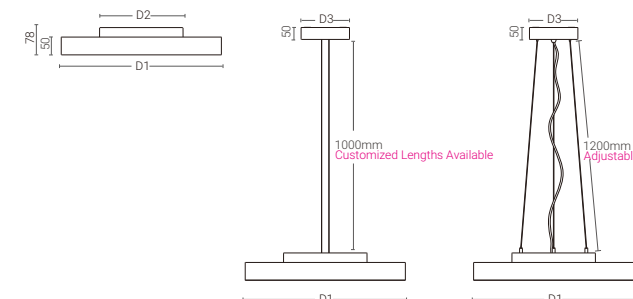

SUGAR

D1: SUGAR 350: D1=Ø350mm
SUGAR 450: D1=Ø450mm
SUGAR 600: D1=Ø600mm
SUGAR 900: D1=Ø900mm

D2: SUGAR 350/ 450: D2=Ø235mm
SUGAR 600/ 900: D2=Ø350mm

D3: Ø136mm

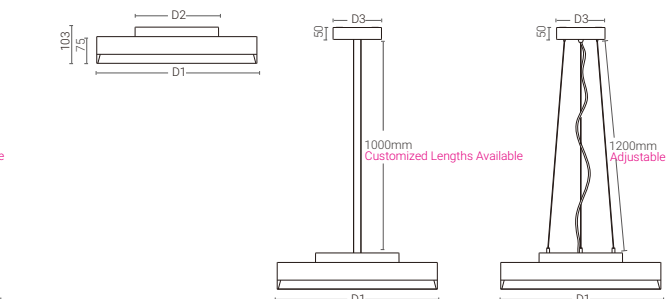

GAME – Ceiling Light System

Project: Skyline Hill, Germany





Project: EWO Administration Building, German



Project: Kindergarten Oftringen, Switzerland

GAME 350 – Ceiling Light System



Quick Info

- LED: 12W, 16W, CRI>80, CRI>90
- CCT: 2700K, 3000K, 4000K Available as Standard, Tunable White Available
- Beam Angle: 90°
- Lumen Output: Up to 2350lm System Luminous Flux
- IP Class: IP40 from Front
- LED Driver: On-Off, Phase Dim, 1-10V Dim, DALI Dim

Light Distribution

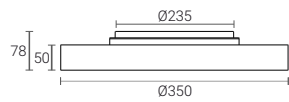

3000K

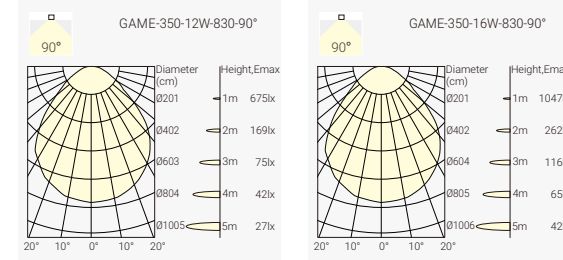

Finish

Surface/ Wall Mounted



Pendant Rod Mounted

* Standard pendant rod length: 1000mm
* Field cuttable pendant rod solution optional



Pendant Wires Mounted

* Standard pendant Wires length: 1200mm



Optional Uplight Module



Magnetic Uplight Module 350

Code for G3PR-8309012N-WN with Uplight Module
G3PR-8309012N-WN-U

Order Info (Surface/ Wall Mounted GAME 350 in Black Housing as an Example)

LED Power	System Power	LED Voltage	LED Current	CRI	CCT	Beam	LED Output	System Output	Code
12W	14W	34V	350mA	80	2700K	90°	2000lm	1600lm	G3SM-8279012N-BN
					3000K	90°	2100lm	1700lm	G3SM-8309012N-BN
					4000K	90°	2300lm	1800lm	G3SM-8409012N-BN
					2700K-6500K	90°	Max.2100lm	Max.1750lm	G3SM-8T29012N-BN
16W	18W	34V	500mA	80	2700K	90°	2500lm	2000lm	G3SM-8279016N-BN
					3000K	90°	2700lm	2150lm	G3SM-8309016N-BN
					4000K	90°	2900lm	2350lm	G3SM-8409016N-BN
					2700K-6500K	90°	Max.2900lm	Max.2500lm	G3SM-8T29016N-BN
Uplight Module									
8W	10W	33V	250mA	80	2700K	110°	950lm	850lm	UM35-827A108N-NN
					3000K	110°	1000lm	900lm	UM35-830A108N-NN
					4000K	110°	1100lm	950lm	UM35-840A108N-NN

Code Remark: N=N(No Driver) F=F(ON-OFF) P=P(Phase Dim) A=A(1-10V Dim) D=D(DALI Dim)

Coding

Model	CRI/ CCT	Beam Angle	LED Power	Control	Finish	Reflector Color	Accessory
G3SM	827	90	12	N	W	N	U
GAME 350 Surface/ Wall Mounted	CR180/ 2700K	90°	12W	No Driver	White	None	Uplight Module
	830		16	F	B		
	CR180/ 3000K		16W	On-Off	Black		
	840			P			
GAME 350 Pendant Wires	CR180/ 4000K			Phase Dim			
	8T2			A			
GAME 350 Pendant Rod	CR180 2700K-6500K Tunable White			1-10V Dim			
	927			D			
	CR190/ 2700K			DALI Dim			
	930						
	CR190/ 3000K						
	940						
	CR190/ 4000K						
	9T2						
	CR190 2700K-6500K Tunable White						

GAME 450 – Ceiling Light System



Quick Info

- LED: 16W, 24W, CRI>80, CRI>90
- CCT: 2700K, 3000K, 4000K Available as Standard, Tunable White Available
- Beam Angle: 90°
- Lumen Output: Up to 3400lm System Luminous Flux
- IP Class: IP40 from Front
- LED Driver: On-Off, Phase Dim, 1-10V Dim, DALI Dim

Light Distribution

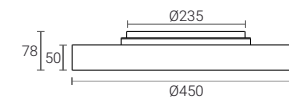

3000K

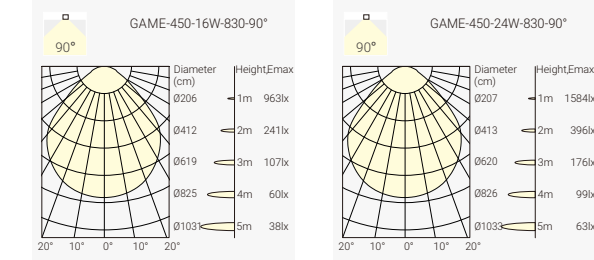

Finish

Surface/ Wall Mounted



Pendant Rod Mounted

* Field cuttable pendant rod solution optional
* Standard pendant rod length: 1000mm



Pendant Wires Mounted

* Standard pendant Wires length: 1200mm



Optional Uplight Module



Magnetic Uplight Module 450

Code for G4PR-8309016N-WN with Uplight Module
G4PR-8309016N-WN-U

Order Info (Surface/ Wall Mounted GAME 450 in Black Housing as an Example)

LED Power	System Power	LED Voltage	LED Current	CRI	CCT	Beam	LED Output	System Output	Code
16W	18W	34V	500mA	80	2700K	90°	2500lm	2150lm	G4SM-8279016N-BN
					3000K	90°	2700lm	2300lm	G4SM-8309016N-BN
					4000K	90°	2900lm	2500lm	G4SM-8409016N-BN
					2700K-6500K	90°	Max.2900lm	Max.2300lm	G4SM-8T09016N-BN
24W	26W	34V	700mA	80	2700K	90°	3500lm	3000lm	G4SM-8279024N-BN
					3000K	90°	3700lm	3150lm	G4SM-8309024N-BN
					4000K	90°	4000lm	3400lm	G4SM-8409024N-BN
					2700K-6500K	90°	Max.4100lm	Max.3200lm	G4SM-8T09024N-BN
Uplight Module									
11W	13W	33V	350mA	80	2700K	110°	1100lm	1000lm	UM45-827A111N-NN
					3000K	110°	1200lm	1100lm	UM45-830A111N-NN
					4000K	110°	1300lm	1200lm	UM45-840A111N-NN

Code Remark: N=N(No Driver) F=F(ON-OFF) P=P(Phase Dim) A=A(1-10V Dim) D=D(DALI Dim)

Coding

Model	CRI/ CCT	Beam Angle	LED Power	Control	Finish	Reflector Color	Accessory
G4SM	827	90	16	N	W	N	U
GAME 450 Surface/ Wall Mounted	CR180/ 2700K	90°	16W	No Driver	White	None	Uplight Module
	830		24	F	B		
	CR180/ 3000K		24W	On-Off	Black		
	840			P			
GAME 450 Pendant Wires	CR180/ 4000K			Phase Dim			
	8T2			A			
GAME 450 Pendant Rod	CR180 2700K-6500K Tunable White			1-10V Dim			
	927			D			
	CR190/ 2700K			DALI Dim			
	930						
	CR190/ 3000K						
	940						
	CR190/ 4000K						
	9T2						
	CR190 2700K-6500K Tunable White						

GAME 600 – Ceiling Light System



Quick Info

- LED: 24W, 36W, 46W, CRI>80, CRI>90
- CCT: 2700K, 3000K, 4000K Available as Standard, Tunable White Available
- Beam Angle: 90°
- Lumen Output: Up to 6700lm System Luminous Flux
- IP Class: IP40 from Front
- LED Driver: On-Off, Phase Dim, 1-10V Dim, DALI Dim

Light Distribution



3000K

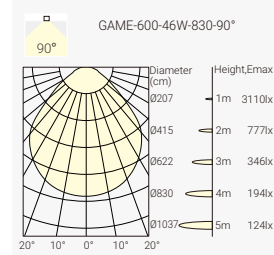
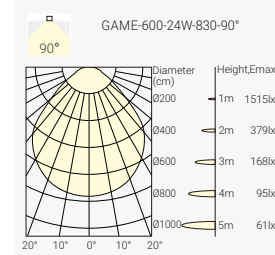

Finish

Surface/ Wall Mounted



Pendant Rod Mounted

* Field cuttable pendant rod solution optional
* Standard pendant rod length: 1000mm



Pendant Wires Mounted

* Standard pendant Wires length: 1200mm



Optional Uplight Module



Code for G6PR-8309036N-WN with Uplight Module
G6PR-8309036N-WN-U

Magnetic Uplight Module 600

Order Info (Surface/ Wall Mounted GAME 600 in Black Housing as an Example)

LED Power	System Power	LED Voltage	LED Current	CRI	CCT	Beam	LED Output	System Output	Code
24W	26W	34V	700mA	80	2700K	90°	3500lm	2850lm	G6SM-8279024N-BN
					3000K	90°	3700lm	3000lm	G6SM-8309024N-BN
					4000K	90°	4000lm	3300lm	G6SM-8409024N-BN
					2700K-6500K	90°	Max.4100lm	Max.3400lm	G6SM-8T29024N-BN
36W	40W	34V	1050mA	80	2700K	90°	5800lm	4750lm	G6SM-8279036N-BN
					3000K	90°	6200lm	5000lm	G6SM-8309036N-BN
					4000K	90°	6600lm	5300lm	G6SM-8409036N-BN
					2700K-6500K	90°	Max.6600lm	Max.5700lm	G6SM-8T29036N-BN
46W	50W	34V	1400mA	80	2700K	90°	7200lm	5850lm	G6SM-8279046N-NN
					3000K	90°	8100lm	6150lm	G6SM-8309046N-NN
					4000K	90°	8600lm	6700lm	G6SM-8409046N-NN
Uplight Module									
18W	20W	36V	500mA	80	2700K	110°	1800lm	1600lm	UM60-827A118N-NN
					3000K	110°	1900lm	1700lm	UM60-830A118N-NN
					4000K	110°	2000lm	1800lm	UM60-840A118N-NN

Code Remark: N=N(No Driver) F=F(ON-OFF) P=P(Phase Dim) A=A(1-10V Dim) D=D(DALI Dim)

Coding

Model	CRI/ CCT	Beam Angle	LED Power	Control	Finish	Reflector Color	Accessory
G6SM	827	90	24	N	W	N	U
GAME 600 Surface/ Wall Mounted	CR180/ 2700K	90°	24W	No Driver	White	None	Uplight Module
	830		36	F	B		
GAME 600 Surface/ Wall Mounted	CR180/ 3000K		36W	On-Off	Black		
	840		46	P			
GAME 600 Pendant Wires	CR180/ 4000K		46W *	Phase Dim			
	8T2			A			
GAME 600 Surface/ Wall Mounted	CR180/ 2700K-6500K Tunable White			1-10V Dim			
	927			D			
GAME 600 Pendant Rod	CR190/ 2700K			DALI Dim			
	930						
GAME 600 Surface/ Wall Mounted	CR190/ 3000K						
	940						
GAME 600 Surface/ Wall Mounted	CR190/ 4000K						
	9T2						
GAME 600 Pendant Rod	CR190/ 2700K-6500K Tunable White						

* LED 46W is not available with Tunable White

GAME 900 – Ceiling Light System



Quick Info

- LED: 60W, CRI>80, CRI>90
- CCT: 2700K, 3000K, 4000K Available as Standard
- Beam Angle: 90°
- Lumen Output: Up to 8700lm System Luminous Flux
- IP Class: IP40 from Front
- LED Driver: On-Off, 1-10V Dim, DALI Dim

Light Distribution

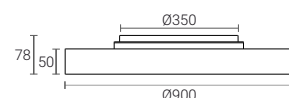

3000K

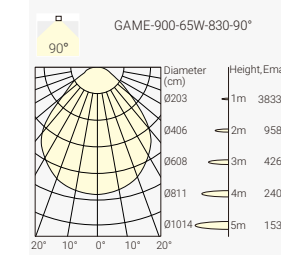

Finish

Surface/ Wall Mounted



Pendant Rod Mounted

* Field cuttable pendant rod solution optional
* Standard pendant rod length: 1000mm



Pendant Wires Mounted

* Standard pendant Wires length: 1200mm



Optional Uplight Module



Code for G9PR-8309060N-WN with Uplight Module
G9PR-8309060N-WN-U

Magnetic Uplight Module 900

Order Info (Surface/ Wall Mounted GAME 900 in Black Housing as an Example)

LED Power	System Power	LED Voltage	LED Current	CRI	CCT	Beam	LED Output	System Output	Code
60W	62W	43V	1400mA	80	2700K	90°	9900lm	7500lm	G9SM-8279060N-BN
					3000K	90°	10500lm	7900lm	G9SM-8309060N-BN
					4000K	90°	11000lm	8700lm	G9SM-8409060N-BN
Uplight Module									
25W	28W	36V	700mA	80	2700K	110°	2900lm	2500lm	UM90-827A128N-NN
					3000K	110°	3100lm	2700lm	UM90-830A128N-NN
					4000K	110°	3300lm	2950lm	UM90-840A128N-NN

Code Remark: N=N(No Driver) F=F(ON-OFF) A=A(1-10V Dim) D=D(DALI Dim)

Coding

Model	CRI/ CCT	Beam Angle	LED Power	Control	Finish	Reflector Color	Accessory
G9SM	827	90	60	N	W	N	U
GAME 900 Surface/ Wall Mounted	CR180/ 2700K	90°	60W	No Driver	White	None	Uplight Module
	830			F	B		
GAME 900 Surface/ Wall Mounted	CR180/ 3000K			On-Off	Black		
	840			A			
GAME 900 Pendant Wires	CR180/ 4000K			1-10V Dim			
	927			D			
GAME 900 Pendant Rod	CR190/ 2700K			DALI Dim			
	930						
GAME 900 Surface/ Wall Mounted	CR190/ 3000K						
	940						
GAME 900 Surface/ Wall Mounted	CR190/ 4000K						



Project: Corporate Office Project, Panama



Project: Office Tensio Trondheim, Norway



SUGAR 350 – Ceiling Light System



Quick Info

- LED: 12W, 16W, CRI>80, CRI>90
- CCT: 2700K, 3000K, 4000K Available as Standard, Tunable White Available
- Beam Angle: 90°
- Lumen Output: Up to 2350lm System Luminous Flux
- IP Class: IP40 from Front
- LED Driver: On-Off, Phase Dim, 1-10V Dim, DALI Dim

Light Distribution

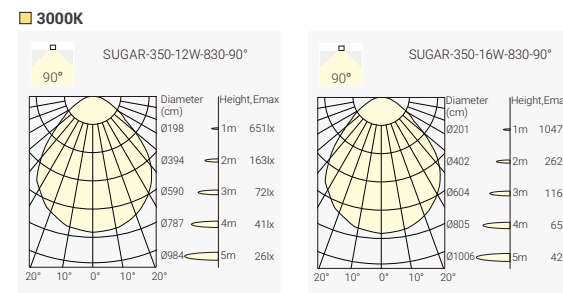
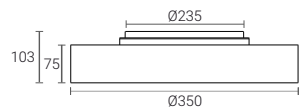

Finish

Surface/ Wall Mounted



Pendant Rod Mounted

* Field cuttable pendant rod solution optional
* Standard pendant rod length: 1000mm



Pendant Wires Mounted

* Standard pendant Wires length: 1200mm



Optional Uplight Module

Code for S3SM-8309012N-BG with Uplight Module
S3SM-8309012N-BG-U



Magnetic Uplight Module 350

Order Info (Surface/ Wall Mounted SUGAR 350 in Black -Gold Finish as an Example)

LED Power	System Power	LED Voltage	LED Current	CRI	CCT	Beam	LED Output	System Output	Code
12W	14W	34V	350mA	80	2700K	90°	2000lm	1600lm	S3SM-8279012N-BG
					3000K	90°	2100lm	1700lm	S3SM-8309012N-BG
					4000K	90°	2300lm	1800lm	S3SM-8409012N-BG
					2700K-6500K	90°	Max.2100lm	Max.1750lm	S3SM-8T29012N-BG
16W	18W	34V	500mA	80	2700K	90°	2500lm	2000lm	S3SM-8279016N-BG
					3000K	90°	2700lm	2150lm	S3SM-8309016N-BG
					4000K	90°	2900lm	2350lm	S3SM-8409016N-BG
					2700K-6500K	90°	Max.2900lm	Max.2500lm	S3SM-8T29016N-BG
8W	10W	33V	250mA	80	2700K	110°	950lm	850lm	UM35-827A108N-NN
					3000K	110°	1000lm	900lm	UM35-830A108N-NN
					4000K	110°	1100lm	950lm	UM35-840A108N-NN

Code Remark: N=N(No Driver) F=F(ON-OFF) P=P(Phase Dim) A=A(1-10V Dim) D=D(DALI Dim)

Coding

Model	CRI/ CCT	Beam Angle	LED Power	Control	Finish	Accessory
S3SM	827	90	12	N	WW	U
SUGAR 350 Surface/ Wall Mounted	CRI80/ 2700K	90°	12W	No Driver	White-White	Uplight Module
	830		16	F	BB	
	CRI80/ 3000K		16W	On-Off	Black-Black	
S3PW	840			P	BG	
SUGAR 350 Pendant Wires	CRI80/ 4000K			Phase Dim	Black-Gold	
S3PR	8T2			A	WG	
SUGAR 350 Pendant Rod	CRI80 2700K-6500K Tunable White			1-10V Dim	White-Gold (Optional)	
	927			D		
	CRI90/ 2700K			DALI Dim		
	930					
	CRI90/ 3000K					
	940					
	CRI90/ 4000K					
	9T2					
	CRI90 2700K-6500K Tunable White					

SUGAR 450 – Ceiling Light System

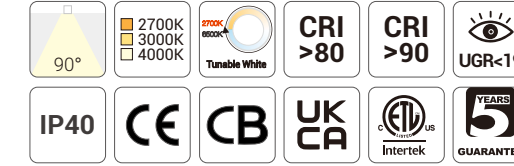

Quick Info

- LED: 16W, 24W, CRI>80, CRI>90
- CCT: 2700K, 3000K, 4000K Available as Standard, Tunable White Available
- Beam Angle: 90°
- Lumen Output: Up to 3400lm System Luminous Flux
- IP Class: IP40 from Front
- LED Driver: On-Off, Phase Dim, 1-10V Dim, DALI Dim

Light Distribution

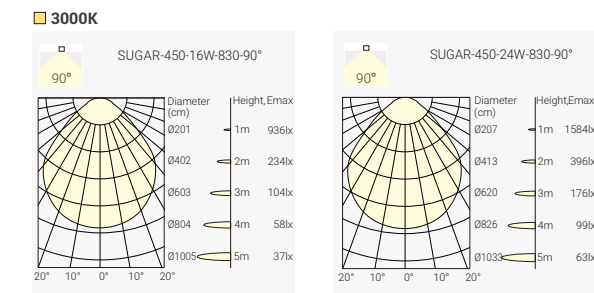
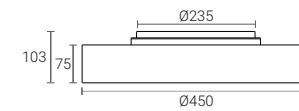

Finish

Surface/ Wall Mounted



Pendant Rod Mounted

* Field cuttable pendant rod solution optional
* Standard pendant rod length: 1000mm



Pendant Wires Mounted

* Standard pendant Wires length: 1200mm



Optional Uplight Module

Code for S4SM-8309016N-WN with Uplight Module
S4SM-8309016N-WN-U



Magnetic Uplight Module 450

Order Info (Surface/ Wall Mounted SUGAR 450 in Black -Gold Finish as an Example)

LED Power	System Power	LED Voltage	LED Current	CRI	CCT	Beam	LED Output	System Output	Code
16W	18W	34V	500mA	80	2700K	90°	2400lm	2150lm	S4SM-8279016N-BG
					3000K	90°	2600lm	2300lm	S4SM-8309016N-BG
					4000K	90°	2800lm	2500lm	S4SM-8409016N-BG
					2700K-6500K	90°	Max.2900lm	Max.2300lm	S4SM-8T29016N-BG
24W	26W	34V	700mA	80	2700K	90°	3500lm	3000lm	S4SM-8279024N-BG
					3000K	90°	3700lm	3150lm	S4SM-8309024N-BG
					4000K	90°	4000lm	3400lm	S4SM-8409024N-BG
					2700K-6500K	90°	Max.4100lm	Max.3200lm	S4SM-8T29024N-BG
11W	13W	33V	350mA	80	2700K	110°	1100lm	1000lm	UM45-827A111N-NN
					3000K	110°	1200lm	1100lm	UM45-830A111N-NN
					4000K	110°	1300lm	1200lm	UM45-840A111N-NN

Code Remark: N=N(No Driver) F=F(ON-OFF) P=P(Phase Dim) A=A(1-10V Dim) D=D(DALI Dim)

Coding

Model	CRI/ CCT	Beam Angle	LED Power	Control	Finish	Accessory
G4SM	827	90	16	N	WW	U
SUGAR 450 Surface/ Wall Mounted	CRI80/ 2700K	90°	16W	No Driver	White-White	Uplight Module
	830		24	F	BB	
	CRI80/ 3000K		24W	On-Off	Black-Black	
G34PW	840			P	BG	
SUGAR 450 Pendant Wires	CRI80/ 4000K			Phase Dim	Black-Gold	
G34PR	8T2			A	WG	
SUGAR 450 Pendant Rod	CRI80 2700K-6500K Tunable White			1-10V Dim	White-Gold (Optional)	
	927			D		
	CRI90/ 2700K			DALI Dim		
	930					
	CRI90/ 3000K					
	940					
	CRI90/ 4000K					
	9T2					
	CRI90 2700K-6500K Tunable White					

SUGAR 600 – Ceiling Light System



Quick Info

- LED: 24W, 36W, 46W, CRI>80, CRI>90
- CCT: 2700K, 3000K, 4000K Available as Standard, Tunable White Available
- Beam Angle: 90°
- Lumen Output: Up to 6700lm System Luminous Flux
- IP Class: IP40 from Front
- LED Driver: On-Off, Phase Dim, 1-10V Dim, DALI Dim

Light Distribution

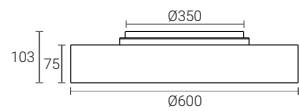

3000K

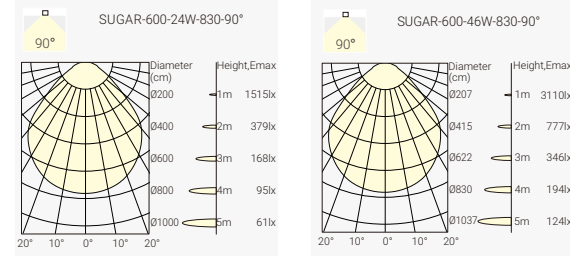

Finish

Surface/ Wall Mounted



Black-Black (BB) Black-Gold (BG) White-White (WW)

Pendant Rod Mounted

* Field cuttable pendant rod solution optional
* Standard pendant rod length: 1000mm



Black-Black (BB) Black-Gold (BG) White-White (WW)

Pendant Wires Mounted

* Standard pendant Wires length: 1200mm



Black-Black (BB) Black-Gold (BG) White-White (WW)

Optional Uplight Module

Code for G6PR-8309036N-BG with Uplight Module
G6PR-8309036N-BG-U



Magnetic Uplight Module 600

Order Info (Surface/ Wall Mounted SUGAR 600 in Black -Gold Finish as an Example)

LED Power	System Power	LED Voltage	LED Current	CRI	CCT	Beam	LED Output	System Output	Code
24W	26W	34V	700mA	80	2700K	90°	3500lm	2850lm	S6SM-8279024N-BG
					3000K	90°	3700lm	3000lm	S6SM-8309024N-BG
					4000K	90°	4000lm	3300lm	S6SM-8409024N-BG
					2700K-6500K	90°	Max.4100lm	Max.3400lm	S6SM-8T29024N-BG
36W	40W	34V	1050mA	80	2700K	90°	5800lm	4750lm	S6SM-8279036N-BG
					3000K	90°	6200lm	5000lm	S6SM-8309036N-BG
					4000K	90°	6600lm	5300lm	S6SM-8409036N-BG
					2700K-6500K	90°	Max.6600lm	Max.5700lm	S6SM-8T29036N-BG
46W	50W	34V	1400mA	80	2700K	90°	7200lm	5850lm	S6SM-8279046N-BG
					3000K	90°	8100lm	6150lm	S6SM-8309046N-BG
					4000K	90°	8600lm	6700lm	S6SM-8409046N-BG
Uplight Module									
18W	20W	36V	500mA	80	2700K	110°	1800lm	1600lm	UM60-827A118N-NN
					3000K	110°	1900lm	1700lm	UM60-830A118N-NN
					4000K	110°	2000lm	1800lm	UM60-840A118N-NN

Code Remark: N=N(No Driver) F=F(ON-OFF) P=P(Phase Dim) A=A(1-10V Dim) D=D(DALI Dim)

Coding

S6SM	-	***	**	**	*	-	**	-	*
Model	CRI/ CCT	Beam Angle	LED Power	Control	Finish	Accessory			
G6SM	827	90	24	N	WW	U			
SUGAR 600 Surface/ Wall Mounted	CR180/ 2700K	90°	24W	No Driver	White-White	Uplight Module			
	830		36	F	BB				
	CR180/ 3000K		36W	On-Off	Black-Black				
	840		46	P	BG				
	CR180/ 4000K		46W *	Phase Dim	Black-Gold				
	8T2			A	WG				
	CR180 2700K-6500K Tunable White			1-10V Dim	White-Gold (Optional)				
	927			D					
	CR190/ 2700K			DALI Dim					
	930								
	CR190/ 3000K								
	940								
	CR190/ 4000K								
	9T2								
	CR190 2700K-6500K Tunable White								

* LED 46W is not available with Tunable White

SUGAR 900 – Ceiling Light System



Quick Info

- LED: 60W, CRI>80, CRI>90
- CCT: 2700K, 3000K, 4000K Available as Standard
- Beam Angle: 90°
- Lumen Output: Up to 8700lm System Luminous Flux
- IP Class: IP40 from Front
- LED Driver: On-Off, 1-10V Dim, DALI Dim

Light Distribution

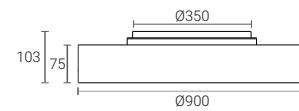

3000K

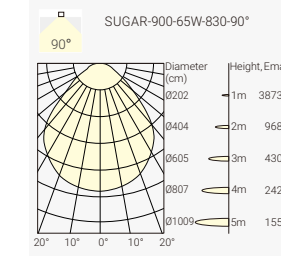

Finish

Surface/ Wall Mounted



Black-Black (BB) Black-Gold (BG) White-White (WW)

Pendant Rod Mounted

* Field cuttable pendant rod solution optional
* Standard pendant rod length: 1000mm



Black-Black (BB) Black-Gold (BG) White-White (WW)

Pendant Wires Mounted

* Standard pendant Wires length: 1200mm



Black-Black (BB) Black-Gold (BG) White-White (WW)

Optional Uplight Module

Code for S9PR-8309060N-BG with Uplight Module
S9PR-8309060N-BG-U



Magnetic Uplight Module 900

Order Info (Surface/ Wall Mounted SUGAR 900 in Black -Gold Finish as an Example)

LED Power	System Power	LED Voltage	LED Current	CRI	CCT	Beam	LED Output	System Output	Code
60W	62W	43V	1400mA	80	2700K	90°	9900lm	7500lm	S9SM-8279060N-BG
					3000K	90°	10500lm	7900lm	S9SM-8309060N-BG
					4000K	90°	11000lm	8700lm	S9SM-8409060N-BG
Uplight Module									
25W	28W	36V	700mA	80	2700K	110°	2900lm	2500lm	UM90-827A128N-NN
					3000K	110°	3100lm	2700lm	UM90-830A128N-NN
					4000K	110°	3300lm	2950lm	UM90-840A128N-NN

Code Remark: N=N(No Driver) F=F(ON-OFF) A=A(1-10V Dim) D=D(DALI Dim)

Coding

S9SM	-	***	**	**	*	-	**	-	*
Model	CRI/ CCT	Beam Angle	LED Power	Control	Finish	Accessory			
S9SM	827	90	60	N	WW	U			
SUGAR 900 Surface/ Wall Mounted	CR180/ 2700K	90°	60W	No Driver	White-White	Uplight Module			
	830			F	BB				
	CR180/ 3000K			On-Off	Black-Black				
	840			A	BG				
	CR180/ 4000K			1-10V Dim	Black-Gold				
	927			D	WG				
	CR190/ 2700K			DALI Dim	White-Gold (Optional)				
	930								
	CR190/ 3000K								
	940								
	CR190/ 4000K								

GLAMOR

3000K-3500K-4000K CCT Switchable

Lumen efficiency up to 130 lm/W

Three diameters available: Ø300, Ø400, Ø600

Surface Mounted and Pendant

IP44, UGR \leq 15



GLAMOR 300 – CCT Switchable LED Ceiling Light

NEW



Quick Info

- LED: 8W, 11W, CRI>80
- CCT: 3000K-3500K-4000K Switchable
- Beam Angle: 80°
- Lumen Output: Up to 1200lm, 1600lm System Luminous Flux
- IP Class: IP44
- LED Driver: On-off, Phase Dim, 1-10V Dim, DALI Dim

Light Distribution

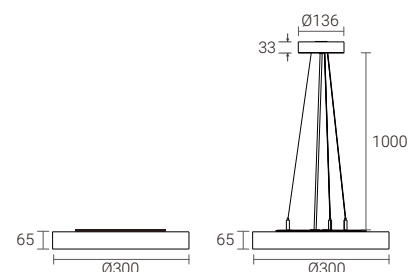

4000K

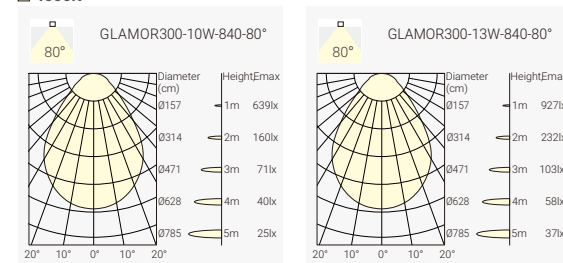

Finish

Surface/ Wall Mounted



Pendant Wires Mounted

* Standard pendant Wires length: 1000mm



Order Info (Surface/ Wall Mounted GLAMOR 300 in White Housing as an Example)

LED Power	System Power	LED Voltage	LED Current	CRI	CCT	Beam	LED Output	System Output	Code
8W	10W	33V	250mA	80	@3000K	80°	1650lm	1100lm	G3RS-8S38010F-WN
					@3500K	80°	1700lm	1150lm	
					@4000K	80°	1800lm	1200lm	
11W	13W	33V	350mA	80	@3000K	80°	2150lm	1450lm	G3RS-8S38013F-WN
					@3500K	80°	2200lm	1500lm	
					@4000K	80°	2300lm	1600lm	

Code Remark: F=F(ON-OFF) P=P(Phase Dim) A=A(1-10V Dim) D=D(DALI Dim)

Coding

Model	CRI/ CCT	Beam Angle	Power	Control	Finish	Reflector Color	Accessory
G3RS	8S3	80°	10	F	W	N	
GLAMOR 300 Surface/ Wall Mounted	CRI>80/ 3000K-3500K-4000K Switchable	80°	10W	On-Off	White	None	
G3RP			13	P	B		
GLAMOR 300 Pendant Wires			13W	Phase Dim	Black		
				A			
				1-10V Dim			
				D			
				DALI Dim			

GLAMOR 400 – CCT Switchable LED Ceiling Light

NEW



Quick Info

- LED: 16W, 23W, CRI>80
- CCT: 3000K-3500K-4000K Switchable
- Beam Angle: 80°
- Lumen Output: Up to 2400lm, 3400lm System Luminous Flux
- IP Class: IP44
- LED Driver: On-off, Phase Dim, 1-10V Dim, DALI Dim

Light Distribution

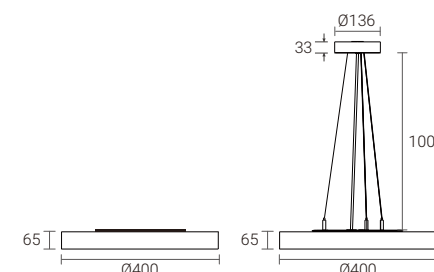

4000K

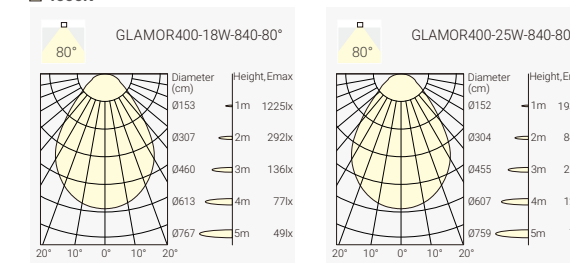

Finish

Surface/ Wall Mounted



Pendant Wires Mounted

* Standard pendant Wires length: 1000mm



Order Info (Surface/ Wall Mounted GLAMOR 400 in White Housing as an Example)

LED Power	System Power	LED Voltage	LED Current	CRI	CCT	Beam	LED Output	System Output	Code
16W	18W	33V	500mA	80	@3000K	80°	3100lm	2200lm	G4RS-8S38018F-WN
					@3500K	80°	3200lm	2300lm	
					@4000K	80°	3300lm	2400lm	
23W	25W	33V	700mA	80	@3000K	80°	4400lm	3100lm	G4RS-8S38025F-WN
					@3500K	80°	4550lm	3200lm	
					@4000K	80°	4650lm	3400lm	

Code Remark: F=F(ON-OFF) P=P(Phase Dim) A=A(1-10V Dim) D=D(DALI Dim)

Coding

Model	CRI/ CCT	Beam Angle	Power	Control	Finish	Reflector Color	Accessory
G4RS	8S3	80°	18	F	W	N	
GLAMOR 400 Surface/ Wall Mounted	CRI>80/ 3000K-3500K-4000K Switchable	80°	18W	On-Off	White	None	
G4RP			25	P	B		
GLAMOR 400 Pendant Wires			25W	Phase Dim	Black		
				A			
				1-10V Dim			
				D			
				DALI Dim			

GLAMOR 600 – CCT Switchable LED Ceiling Light

NEW

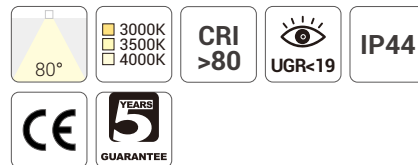

Quick Info

- LED: 34W, 40W, CRI>80
- CCT: 3000K-3500K-4000K Switchable
- Beam Angle: 80°
- Lumen Output: Up to 5300lm, 5900lm System Luminous Flux
- IP Class: IP44
- LED Driver: On-off, Phase Dim, 1-10V Dim, DALI Dim

Light Distribution

□ 4000K

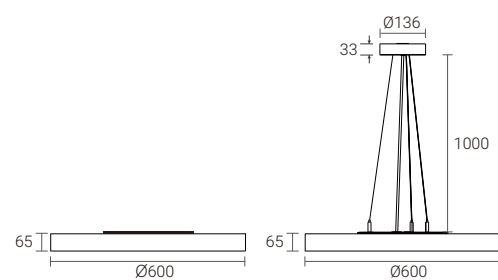
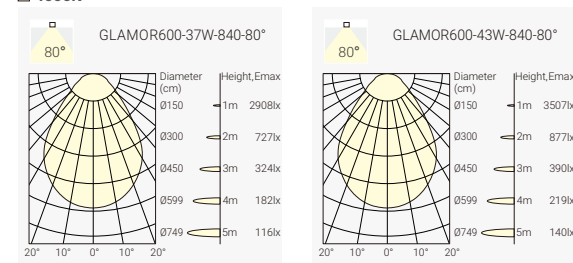

Finish

Surface/ Wall Mounted



Pendant Wires Mounted

* Standard pendant Wires length: 1000mm



Order Info (Surface/ Wall Mounted GLAMOR 600 in White Housing as an Example)

LED Power	System Power	LED Voltage	LED Current	CRI	CCT	Beam	LED Output	System Output	Code
34W	37W	33V	1050mA	80	@3000K	80°	6650lm	5000lm	G6RS-8S38037F-WN
					@3500K	80°	6800lm	5200lm	
					@4000K	80°	6950lm	5300lm	
40W	43W	33V	1200mA	80	@3000K	80°	7500lm	5600lm	G6RS-8S38043F-WN
					@3500K	80°	7650lm	5700lm	
					@4000K	80°	7800lm	5900lm	

Code Remark: F=F(ON-OFF) P=P(Phase Dim) A=A(1-10V Dim) D=D(DALI Dim)

Coding

Model	CRI/ CCT	Beam Angle	Power	Control	Finish	Reflector Color	Accessory
G6RS	8S3	80	37	F	W	N	
GLAMOR 600 Surface/ Wall Mounted	CRI>80/ 3000K-3500K-4000K Switchable	80°	37W	On-Off	White	None	
G6RP			43	P	B		
GLAMOR 600 Pendant Wires			43W	Phase Dim	Black		
				A			
				1-10V Dim			
				D			
				DALI Dim			



Project: Application Reference

MINT

3000K-3500K-4000K CCT Switchable
Power Switchable
IP54



MINT 280 – CCT Switchable & Power Switchable LED Ceiling Light



Quick Info

- Power Switchable 13W-18W-24W, CRI>80
- CCT Switchable 2700K-3000K-4000K
- Beam Angle: 120°
- Lumen Output: Up to 2350lm System Luminous Flux
- IP Class: IP54
- LED Driver: On-Off

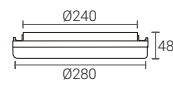

Light Distribution

3000K

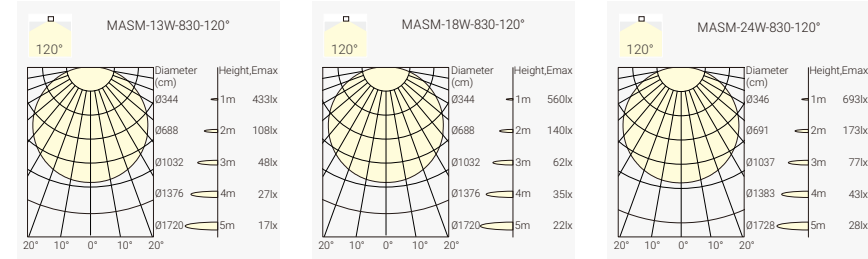

Finish



White

Order Info

LED Power	System Power	LED Voltage	LED Current	CRI	CCT	Beam	LED Output	System Output	Code
12W	13W	78V	155mA	80	@2700K @3000K @4000K	120°	1600lm 1700lm 1800lm	1350lm 1400lm 1500lm	MASM-8S3A224F-WN
16W	18W	78V	200mA	80	@2700K @3000K @4000K	120°	2000lm 2100lm 2200lm	1700lm 1800lm 1900lm	MASM-8S3A224F-WN
22W	24W	78V	280mA	80	@2700K @3000K @4000K	120°	2400lm 2550lm 2600lm	2100lm 2200lm 2350lm	MASM-8S3A224F-WN

Code Remark: F=Off (On-Off LED Driver, Power Switchable)



MINT 280 – CCT Switchable & Power Switchable LED Ceiling Light



Quick Info

- Power Switchable 13W-18W-24W, CRI>80
- CCT Switchable 2700K-3000K-4000K
- Beam Angle: 120°
- Lumen Output: Up to 2350lm System Luminous Flux
- IP Class: IP54
- LED Driver: On-Off LED Driver+Microwave Sensor

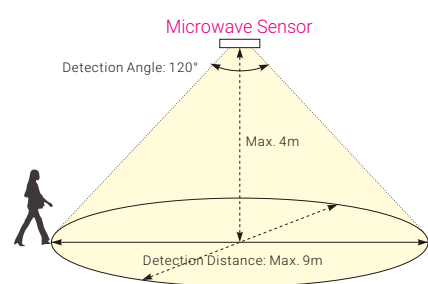
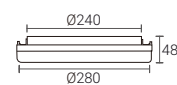

Light Distribution

3000K

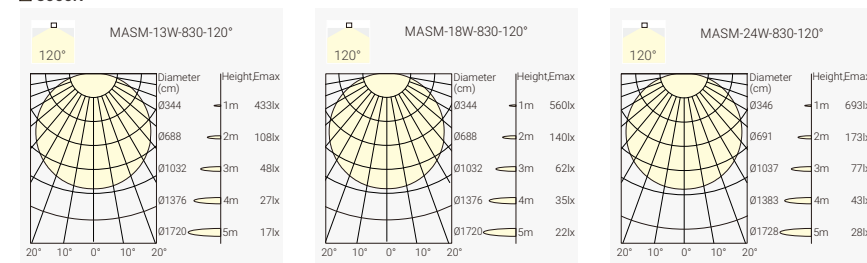

Order Info

LED Power	System Power	LED Voltage	LED Current	CRI	CCT	Beam	LED Output	System Output	Code
12W	13W	78V	155mA	80	@2700K @3000K @4000K	120°	1600lm 1700lm 1800lm	1350lm 1400lm 1500lm	MASM-8S3A224S-WN
16W	18W	78V	200mA	80	@2700K @3000K @4000K	120°	2000lm 2100lm 2200lm	1700lm 1800lm 1900lm	MASM-8S3A224S-WN
22W	24W	78V	280mA	80	@2700K @3000K @4000K	120°	2400lm 2550lm 2600lm	2100lm 2200lm 2350lm	MASM-8S3A224S-WN

Code Remark: S=S(On-Off LED Driver+Microwave Sensor)

Finish



White

MINT 280 – CCT Switchable & Power Switchable LED Ceiling Light



Quick Info

- Power Switchable 13W-18W-24W, CRI>80
- CCT Switchable 2700K-3000K-4000K
- Beam Angle: 120°
- Lumen Output: Up to 2350lm System Luminous Flux
- IP Class: IP54
- LED Driver: On-Off LED Driver+Emergency Backup

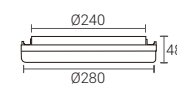

Light Distribution

3000K

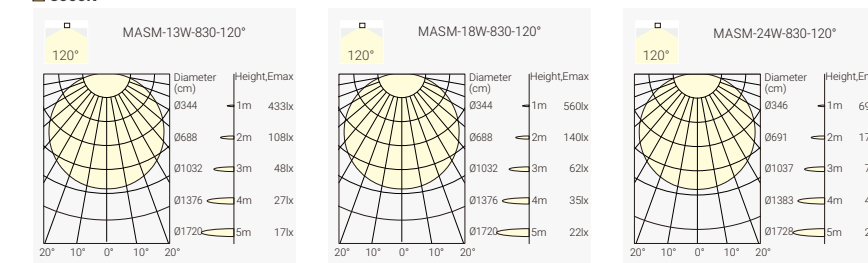

Order Info

LED Power	System Power	LED Voltage	LED Current	CRI	CCT	Beam	LED Output	System Output	Code
12W	13W	78V	155mA	80	@2700K @3000K @4000K	120°	1600lm 1700lm 1800lm	1350lm 1400lm 1500lm	MASM-8S3A224E-WN
16W	18W	78V	200mA	80	@2700K @3000K @4000K	120°	2000lm 2100lm 2200lm	1700lm 1800lm 1900lm	MASM-8S3A224E-WN
22W	24W	78V	280mA	80	@2700K @3000K @4000K	120°	2400lm 2550lm 2600lm	2100lm 2200lm 2350lm	MASM-8S3A224E-WN

Code Remark: E=E(On-Off LED Driver+Emergency Backup)

Finish



White

SKYDRIVER SKYJOY SKYLINE

LED Ceiling Light
Incl. Phase Dim Driver & Fast Connector



SKYDRIVER SDRC – LED Ceiling light Incl. Phase Dim Driver



Quick Info

- CITIZEN LED: 10W, CRI>90
- CCT: 2700K, 3000K Available as Standard
- Beam Angle: 36°
- Lumen Output: Up to 780lm System Luminous Flux
- IP Class: IP20
- LED Driver: Phase Dim

Light Distribution

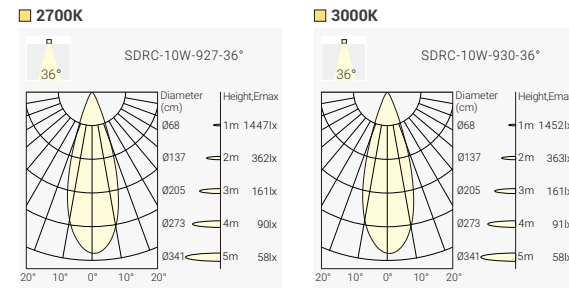
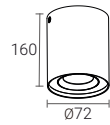

Finish



Order Info

LED Power	System Power	LED Voltage	LED Current	CRI	CCT	Beam	LED Output	System Output	Code
8W	10W	36V	230mA	90	2700K	36°	950lm	750lm	SDRC-9273610P-WW
					3000K	36°	1000lm	780lm	SDRC-9303610P-WW
8W	10W	36V	230mA	90	2700K	36°	950lm	750lm	SDRC-9273610P-BB
					3000K	36°	1000lm	780lm	SDRC-9303610P-BB

Code Remark: P=P(Phase Dim)

SKYDRIVER SDSC – LED Ceiling light Incl. Phase Dim Driver

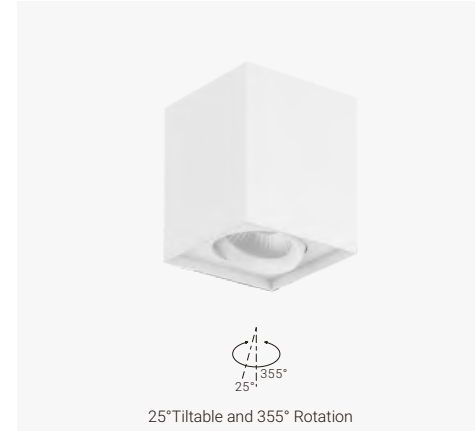

Quick Info

- CITIZEN LED: 10W, CRI>90
- CCT: 2700K, 3000K Available as Standard
- Beam Angle: 36°
- Lumen Output: Up to 780lm System Luminous Flux
- IP Class: IP20
- LED Driver: Phase Dim

Light Distribution

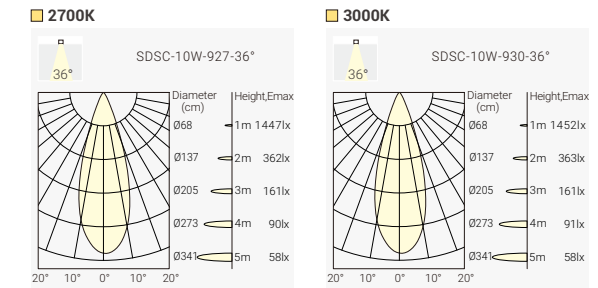
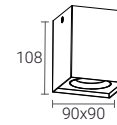

Finish



Order Info

LED Power	System Power	LED Voltage	LED Current	CRI	CCT	Beam	LED Output	System Output	Code
8W	10W	36V	230mA	90	2700K	36°	950lm	750lm	SDSC-9273610P-WW
					3000K	36°	1000lm	780lm	SDSC-9303610P-WW
8W	10W	36V	230mA	90	2700K	36°	950lm	750lm	SDSC-9273610P-BB
					3000K	36°	1000lm	780lm	SDSC-9303610P-BB

Code Remark: P=P(Phase Dim)

SKYJOY SJSC – LED Ceiling light Incl. Phase Dim Driver

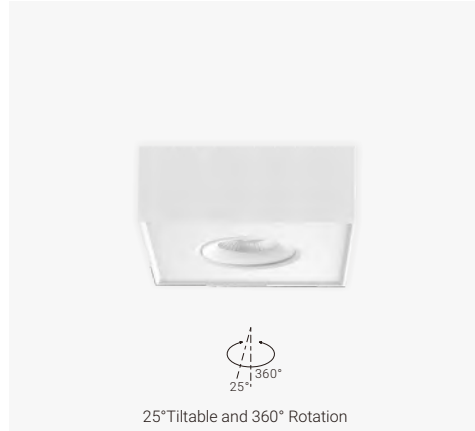

Quick Info

- CITIZEN LED: 8W, CRI>90
- CCT: 2700K Available as Standard
- Beam Angle: 36°
- Lumen Output: Up to 580lm System Luminous Flux
- IP Class: IP20
- LED Driver: Phase Dim

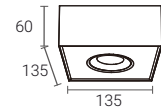

Light Distribution

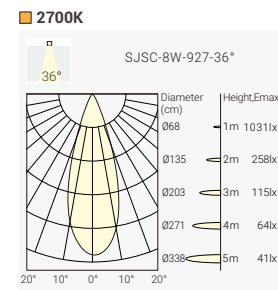

Finish



Order Info

LED Power	System Power	LED Voltage	LED Current	CRI	CCT	Beam	LED Output	System Output	Code
7W	10W	36V	200mA	90	2700K	36°	750lm	580lm	SJSC-9303610P-WW
7W	10W	36V	200mA	90	2700K	36°	750lm	580lm	SJSC-9303610P-BB

Code Remark: P=P(Phase Dim)

SKYJOY SJSC – LED Ceiling light Incl. Phase Dim Driver



Quick Info

- BRIDGELUX LED: 10W, CRI>90
- CCT: Dim to Warm 1800K-3000K
- Beam Angle: 36°
- Lumen Output: Up to Max.650lm System Luminous Flux
- IP Class: IP20
- LED Driver: Phase Dim

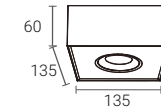

Light Distribution

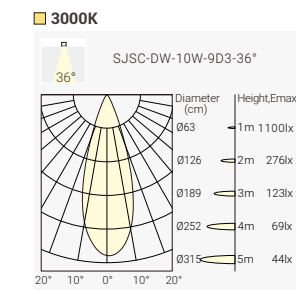

Finish

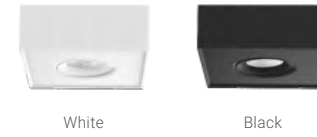

Order Info

LED Power	System Power	LED Voltage	LED Current	CRI	CCT	Beam	LED Output	System Output	Code
9W	10W	36V	250mA	90	1800K-3000K	36°	850lm	Max.650lm	SJSC-9D33610P-WW
9W	10W	36V	250mA	90	1800K-3000K	36°	850lm	Max.650lm	SJSC-9D33610P-BB

Code Remark: P=P(Phase Dim)

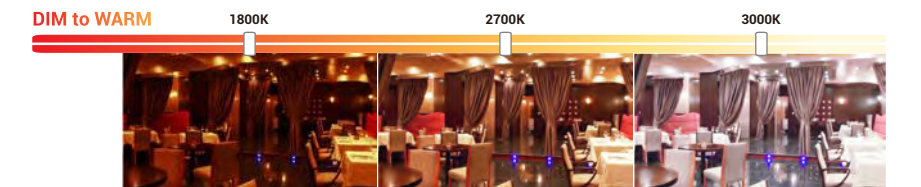



Quick Info

- CITIZEN LED: 16W, CRI>90
- CCT: 2700K Available as Standard
- Beam Angle: 36°
- Lumen Output: Up to 1300lm System Luminous Flux
- IP Class: IP20
- LED Driver: Phase Dim

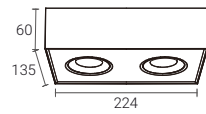

Light Distribution

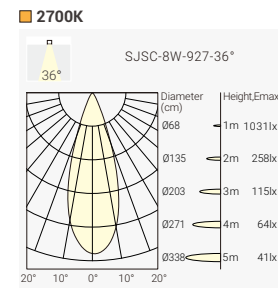

Finish



White

Black

Order Info

LED Power	System Power	LED Voltage	LED Current	CRI	CCT	Beam	LED Output	System Output	Code
14W	16W	36V	400mA	90	2700K	36°	1600lm	1300lm	SJDC-9273616P-WW
14W	16W	36V	400mA	90	2700K	36°	1600lm	1300lm	SJDC-9273616P-BB

Code Remark: P=P(Phase Dim)



Quick Info

- BRIDGELUX LED: 16W, CRI>90
- CCT: Dim to Warm 1800K-3000K
- Beam Angle: 36°
- Lumen Output: Up to Max.1300lm System Luminous Flux
- IP Class: IP20
- LED Driver: Phase Dim

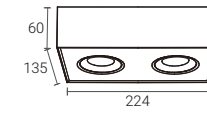

Light Distribution

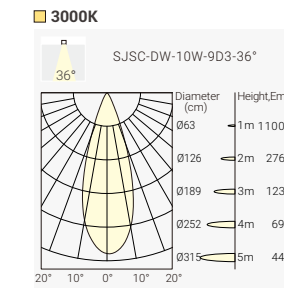

Finish



White

Black

Order Info

LED Power	System Power	LED Voltage	LED Current	CRI	CCT	Beam	LED Output	System Output	Code
18W	20W	36V	500mA	90	1800K-3000K	36°	1700lm	Max.1300lm	SJDC-9D33620P-WW
18W	20W	36V	500mA	90	1800K-3000K	36°	1700lm	Max.1300lm	SJDC-9D33620P-BB

Code Remark: P=P(Phase Dim)



SKYJOY SL5C – LED Ceiling light Incl. Phase Dim Driver



Quick Info

- Bridgelux LED: 8.5W, CRI>90
- CCT: 2700K, 3000K Available as Standard
- Beam Angle: 30°
- Lumen Output: Up to 750lm System Luminous Flux
- IP Class: IP20 from Front
- LED Driver: Phase Dim

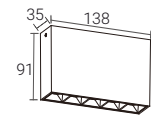

Light Distribution

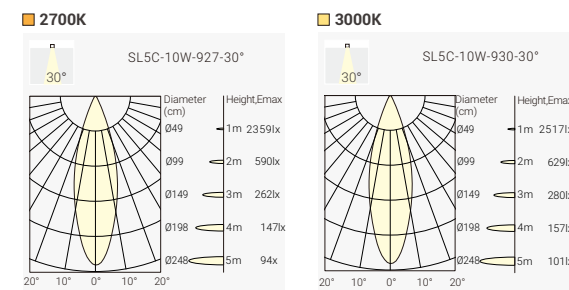

Finish



White-Specular (WS)



Black-Specular (BS)

Order Info

LED Power	System Power	LED Voltage	LED Current	CRI	CCT	Beam	LED Output	System Output	Code
8.5W	10W	14.5V	600mA	90	2700K	30°	950lm	720lm	SL5C-9273010P-WS
					3000K	30°	1000lm	750lm	SL5C-9303010P-WS
8.5W	10W	14.5V	600mA	90	2700K	30°	950lm	720lm	SL5C-9273010P-BS
					3000K	30°	1000lm	750lm	SL5C-9303010P-BS

Code Remark: P=P(Phase Dim)

Project: Hovenloen Restaurant, Norway

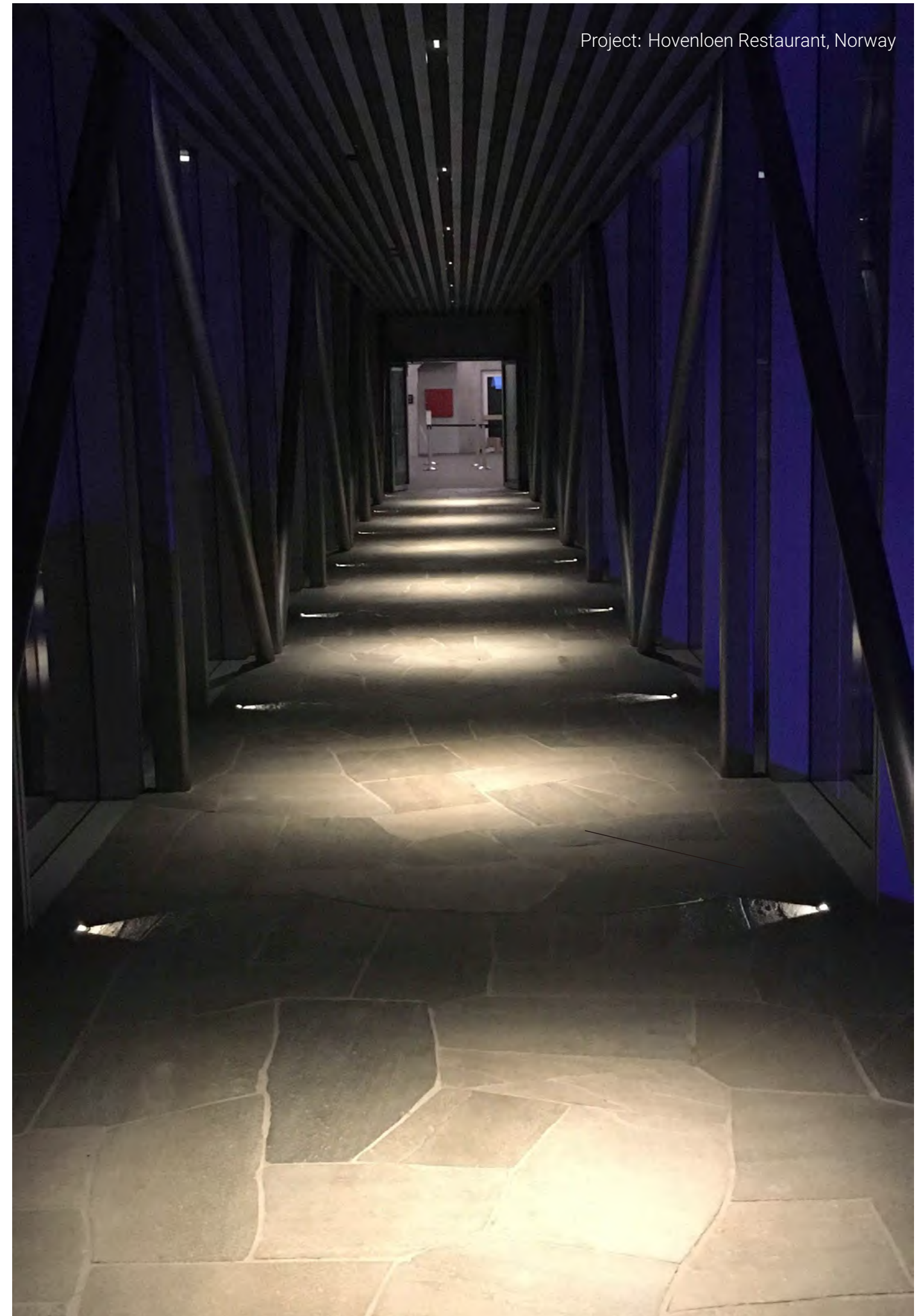

MIU

Architectural
Ceiling Light & Pendant Light
Elegant Design, No Visible Screw



Project: Office Borg Forvaltning Trondheim, Norway



Project: Office Borg Forvaltning Trondheim, Norway

MIU-C M – Ceiling Mounted Light

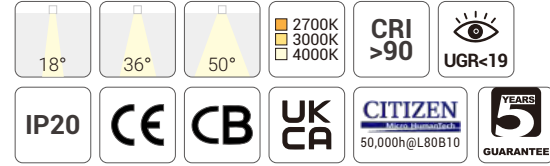

Quick Info

- CITIZEN LED: 15W, 21W, CRI>90
- CCT: 2700K, 3000K, 4000K Available as Standard
- Beam Angle: 15°, 36°, 50°
- Lumen Output: Up to 1900lm System Luminous Flux
- IP Class: IP20
- LED Driver: On-Off, Phase Dim

Light Distribution

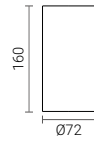
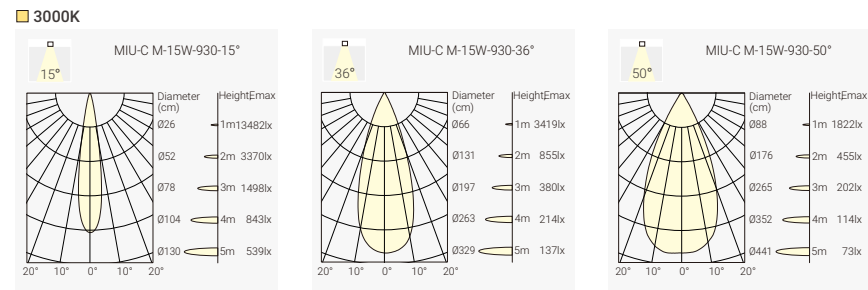

Finish



Order Info (MIU-C M in White Housing & Black Reflector as an Example)

LED Power	System Power	LED Voltage	LED Current	CRI	CCT	Beam	LED Output	System Output	Code						
13W	15W	36V	350mA	90	2700K	15°	1400lm	1100lm	MCM1-9271515F-WB						
						36°	1400lm	1150lm	MCM1-9273615F-WB						
						50°	1400lm	1100lm	MCM1-9275015F-WB						
						3000K	15°	1500lm	1200lm	MCM1-9301515F-WB					
							36°	1500lm	1250lm	MCM1-9303615F-WB					
							50°	1500lm	1200lm	MCM1-9305015F-WB					
						4000K	15°	1600lm	1300lm	MCM1-9401515F-WB					
							36°	1600lm	1350lm	MCM1-9403615F-WB					
							50°	1600lm	1300lm	MCM1-9405015F-WB					
						18W	21W	36V	500mA	90	2700K	15°	1900lm	1600lm	MCM2-9271521F-WB
												36°	1900lm	1700lm	MCM2-9273621F-WB
												50°	1900lm	1600lm	MCM2-9275021F-WB
3000K	15°	2000lm	1700lm	MCM2-9301521F-WB											
	36°	2000lm	1800lm	MCM2-9303621F-WB											
	50°	2000lm	1700lm	MCM2-9305021F-WB											
4000K	15°	2100lm	1800lm	MCM2-9401521F-WB											
	36°	2100lm	1900lm	MCM2-9403621F-WB											
	50°	2100lm	1800lm	MCM2-9405021F-WB											

Code Remark: F=F(ON-OFF) P=P(Phase Dim) D=D(DALI Dim)

Reflector Options



Coding

Model	CRI/ CCT	Beam Angle	Power	Control	Finish	Reflector Color	Accessory
MCM1	927	15	15	F	W	W	H
MIU-C M-15W	CRI90/ 2700K	15°	15W	On-Off	White	White	Honeycomb
MCM2	930	36	21	P*	B	B	
MIU-C M-21W	CRI90/ 3000K	36°	21W	Phase Dim	Black	Black	
	940	50		D*		G	
	CRI90/ 4000K	50°		DALI Dim		Gold	

* 21W is not available with Phase Dim, DALI Dim

Optional accessory

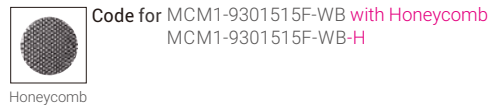

MIU-C L – Ceiling Mounted Light

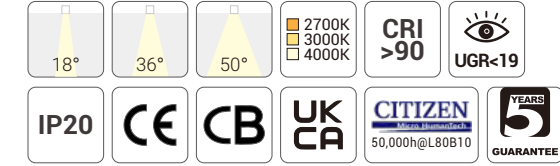

Quick Info

- CITIZEN LED: 28W, CRI>90
- CCT: 2700K, 3000K, 4000K Available as Standard
- Beam Angle: 18°, 36°, 50°
- Lumen Output: Up to 2900lm System Luminous Flux
- IP Class: IP20
- LED Driver: On-Off, DALI Dim

Light Distribution

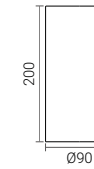
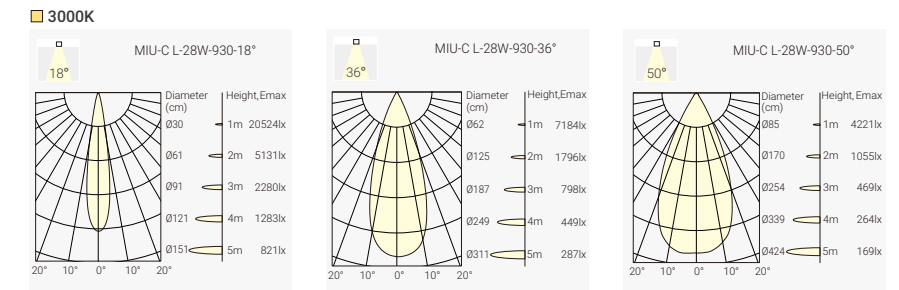

Finish



Order Info (MIU-C L in White Housing & Black Reflector as an Example)

LED Power	System Power	LED Voltage	LED Current	CRI	CCT	Beam	LED Output	System Output	Code	
25W	28W	36V	700mA	90	2700K	18°	3200lm	2500lm	MCL1-9271828F-WB	
						36°	3200lm	2500lm	MCL1-9273628F-WB	
						50°	3200lm	2500lm	MCL1-9275028F-WB	
						3000K	18°	3400lm	2700lm	MCL1-9301828F-WB
							36°	3400lm	2700lm	MCL1-9303628F-WB
							50°	3400lm	2700lm	MCL1-9305028F-WB
						4000K	18°	3600lm	2900lm	MCL1-9401828F-WB
							36°	3600lm	2900lm	MCL1-9403628F-WB
							50°	3600lm	2900lm	MCL1-9405028F-WB

Code Remark: F=F(ON-OFF) D=D(DALI Dim)

Reflector Options



Coding

Model	CRI/ CCT	Beam Angle	Power	Control	Finish	Reflector Color	Accessory
MCM1	927	18	28	F	W	W	H
MIU-C L	CRI90/ 2700K	18°	28W	On-Off	White	White	Honeycomb
	930	36		D	B	B	
	CRI90/ 3000K	36°					
	940	50					
	CRI90/ 4000K	50°				G	

Optional accessory

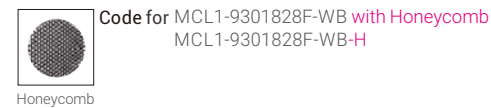

MIU-P S – Pendant Light

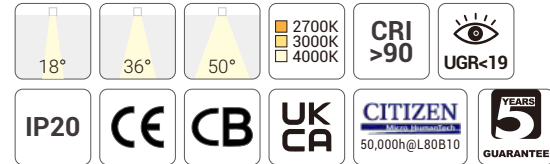

Quick Info

- CITIZEN LED: 11W, CRI>90
- CCT: 2700K, 3000K, 4000K Available as Standard
- Beam Angle: 18°, 36°, 50°
- Lumen Output: Up to 880lm System Luminous Flux
- IP Class: IP20
- LED Driver: On-Off, Phase Dim, DALI Dim

Light Distribution

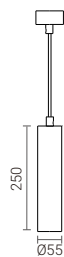
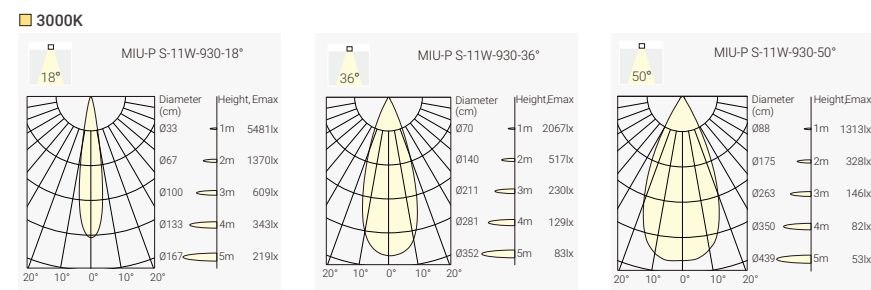

Finish



Order Info (MIU-P S in White Housing & Black Reflector as an Example)

LED Power	System Power	LED Voltage	LED Current	CRI	CCT	Beam	LED Output	System Output	Code
9W	11W	36V	250mA	90	2700K	18°	900lm	750lm	MPS1-9271811F-WB
						36°	900lm	750lm	MPS1-9273611F-WB
						50°	900lm	750lm	MPS1-9275011F-WB
					3000K	18°	1000lm	800lm	MPS1-9301811F-WB
						36°	1000lm	800lm	MPS1-9303611F-WB
						50°	1000lm	800lm	MPS1-9305011F-WB
					4000K	18°	1100lm	880lm	MPS1-9401811F-WB
						36°	1100lm	880lm	MPS1-9403611F-WB
						50°	1100lm	880lm	MPS1-9405011F-WB

Code Remark: F=F(ON-OFF) P=P(Phase Dim) D=D(DALI Dim)

Coding

Model	CRI/ CCT	Beam Angle	Power	Control	Finish	Reflector Color	Accessory
MPS1	927	15°	11	F	W	W	H
MIU-P S-11W	CR190/ 2700K	15°	11W	On-Off	White	White	Honeycomb
	930	36°		P	B	B	
	CR190/ 3000K	36°		Phase Dim	Black	Black	
	940	50°		D	G	G	
	CR190/ 4000K	50°		DALI Dim	Gold	Gold	

Reflector Options

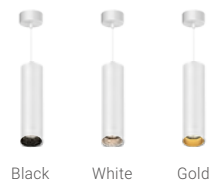

Optional accessory

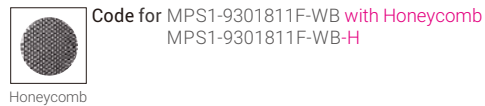

MIU-P M – Pendant Light

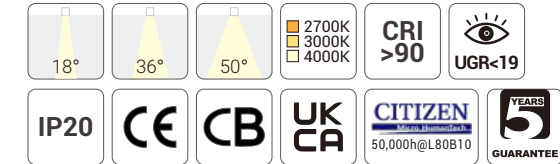

Quick Info

- CITIZEN LED: 15W, 21W, CRI>90
- CCT: 2700K, 3000K, 4000K Available as Standard
- Beam Angle: 15°, 36°, 50°
- Lumen Output: Up to 1900lm System Luminous Flux
- IP Class: IP20
- LED Driver: On-Off, Phase Dim

Light Distribution

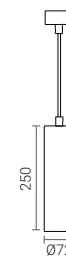
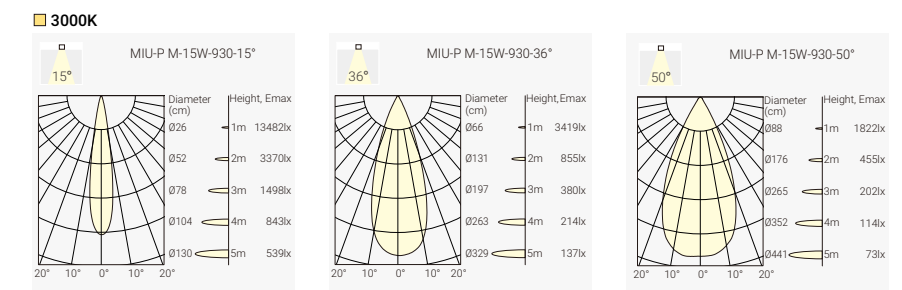

Finish



Order Info (MIU-P M in White Housing & Black Reflector as an Example)

LED Power	System Power	LED Voltage	LED Current	CRI	CCT	Beam	LED Output	System Output	Code
13W	15W	36V	350mA	90	2700K	15°	1400lm	1100lm	MPM1-9271515F-WB
						36°	1400lm	1100lm	MPM1-9273615F-WB
						50°	1400lm	1100lm	MPM1-9275015F-WB
					3000K	15°	1500lm	1200lm	MPM1-9301515F-WB
						36°	1500lm	1250lm	MPM1-9303615F-WB
						50°	1500lm	1200lm	MPM1-9305015F-WB
					4000K	15°	1600lm	1300lm	MPM1-9401515F-WB
						36°	1600lm	1350lm	MPM1-9403615F-WB
						50°	1600lm	1300lm	MPM1-9405015F-WB

Code Remark: F=F(ON-OFF) P=P(Phase Dim) D=D(DALI Dim)

Reflector Options



Optional accessory

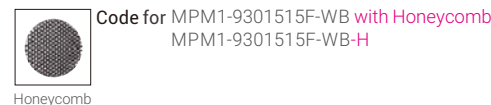

Coding

Model	CRI/ CCT	Beam Angle	Power	Control	Finish	Reflector Color	Accessory
MPM1	927	15°	15	F	W	W	H
MIU-P M-15W	CR190/ 2700K	15°	15W	On-Off	White	White	Honeycomb
	930	36°	21	P*	B	B	
	CR190/ 3000K	36°	21W	Phase Dim	Black	Black	
	940	50°		D*	G	G	
	CR190/ 4000K	50°		DALI Dim	Gold	Gold	

* 21W is not available with Phase Dim, DALI Dim

MIU -P L – Pendant Light

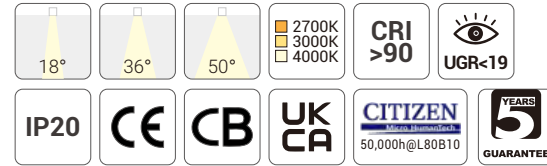

Quick Info

- CITIZEN LED: 28W, CRI>90
- CCT: 2700K, 3000K, 4000K Available as Standard
- Beam Angle: 18°, 36°, 50°
- Lumen Output: Up to 2900lm System Luminous Flux
- IP Class: IP20
- LED Driver: On-Off, DALI Dim

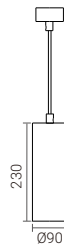

Light Distribution

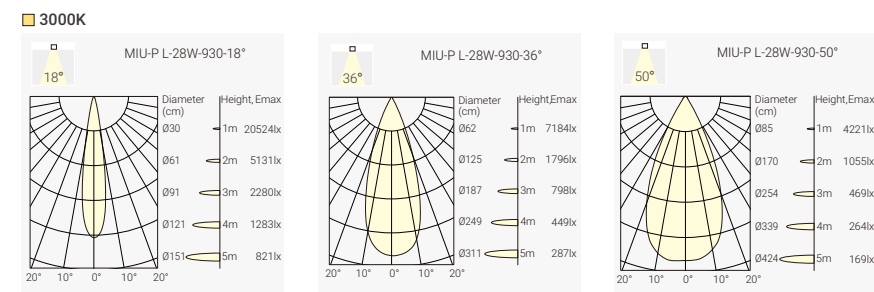

Finish



White Black

Order Info (MIU-P L in White Housing & Black Reflector as an Example)

LED Power	System Power	LED Voltage	LED Current	CRI	CCT	Beam	LED Output	System Output	Code
25W	28W	36V	700mA	90	2700K	18°	3200lm	2500lm	MPL1-9271828F-WB
						36°	3200lm	2500lm	MPL1-9273628F-WB
						50°	3200lm	2500lm	MPL1-9275028F-WB
					3000K	18°	3400lm	2700lm	MPL1-9301828F-WB
						36°	3400lm	2700lm	MPL1-9303628F-WB
						50°	3400lm	2700lm	MPL1-9305028F-WB
					4000K	18°	3600lm	2900lm	MPL1-9401828F-WB
						36°	3600lm	2900lm	MPL1-9403628F-WB
						50°	3600lm	2900lm	MPL1-9405028F-WB

Code Remark: F=F(ON-OFF) D=D(DALI Dim)

Reflector Options



Black White Gold

Coding

Model	CRI/ CCT	Beam Angle	Power	Control	Finish	Reflector Color	Accessory
MPL1 MIU-P L-28W	927 CRI90/ 2700K	15°	28 28W	F On-Off	W White	W White	H Honeycomb
	930 CRI90/ 3000K	36°		D DALI Dim	B Black	B Black	
	940 CRI90/ 4000K	50°				G Gold	

Optional accessory



Honeycomb

Code for MPL1-9301828F-WB with Honeycomb
MPL1-9301828F-WB-H



MIU Art

Minimum & Flat Design

Within AC LED Board, No Additional Power Supply Required

Phase Dimming Compatible

Easy Installation



MIU Art-S – Ceiling Mounted Light

NEW

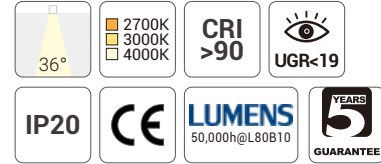

Quick Info

- LUMENS LED: AC COB, 4W, CRI>90
- CCT: 2700K, 3000K, 4000K Available as Standard
- Beam Angle: 36°
- Lumen Output: Up to 240lm System Luminous Flux
- IP Class: IP20
- Dimming: 220-240VAC Direct Input, Phase Dim

Light Distribution

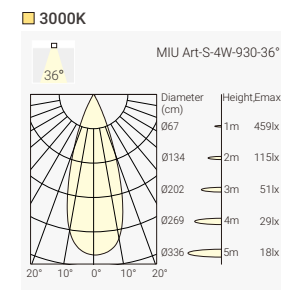

Standard Finish



White Black

Optional Finish



Gold Chrome Silver Brown
*Customized Colors Optional

Order Info (MIU Art-S in Black Housing as an Example)

LED Power	System Power	Input Power	CRI	CCT	Beam	LED Output	System Output	Code
3W	4W	220-240VAC	90	2700K	36°	300lm	210lm	MIAS-9273604P-BB
				3000K	36°	320lm	220lm	MIAS-9303604P-BB
				4000K	36°	350lm	240lm	MIAS-9403604P-BB

Code Remark: P=P(Phase Dim)

Coding

Model	CRI/ CCT	Beam Angle	Power	Control	Finish	Accessory
MIAS	927	36	04	P	WW	
MIU Art-S-4W	CRI90/ 2700K	36°	4W	Phase Dim	White	
	930				BB	
	CRI90/ 3000K				Black	
	940				GG	
	CRI90/ 4000K				Gold	
					CR	
					Chrome	
					SL	
					Silver	
					BR	
					Brown	

MIU Art-M – Ceiling Mounted Light

NEW



Quick Info

- LUMENS LED: AC COB, 8W, CRI>90
- CCT: 2700K, 3000K, 4000K Available as Standard
- Beam Angle: 48°
- Lumen Output: Up to 600lm System Luminous Flux
- IP Class: IP20
- Dimming: 220-240VAC Direct Input, Phase Dim

Light Distribution

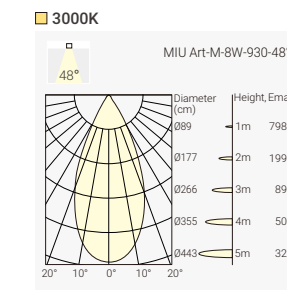

Standard Finish



White Black

Optional Finish



Gold Chrome Silver Brown
*Customized Colors Optional

Order Info (MIU Art-M in Black Housing as an Example)

LED Power	System Power	Input Power	CRI	CCT	Beam	LED Output	System Output	Code
7W	8W	220-240VAC	90	2700K	48°	670lm	520lm	MIAM-9274808P-BB
				3000K	48°	700lm	550lm	MIAM-9304808P-BB
				4000K	48°	750lm	600lm	MIAM-9404808P-BB

Code Remark: P=P(Phase Dim)

Coding

Model	CRI/ CCT	Beam Angle	Power	Control	Finish	Accessory
MIAM	927	48	08	P	WW	
MIU Art-M-8W	CRI90/ 2700K	48°	8W	Phase Dim	White	
	930				BB	
	CRI90/ 3000K				Black	
	940				GG	
	CRI90/ 4000K				Gold	
					CR	
					Chrome	
					SL	
					Silver	
					BR	
					Brown	

BREEZE

Ceiling Mounted Spotlight
Incl. Phase Dim Driver & Fast Connector



BREEZE – Ceiling Mounted Soptlight

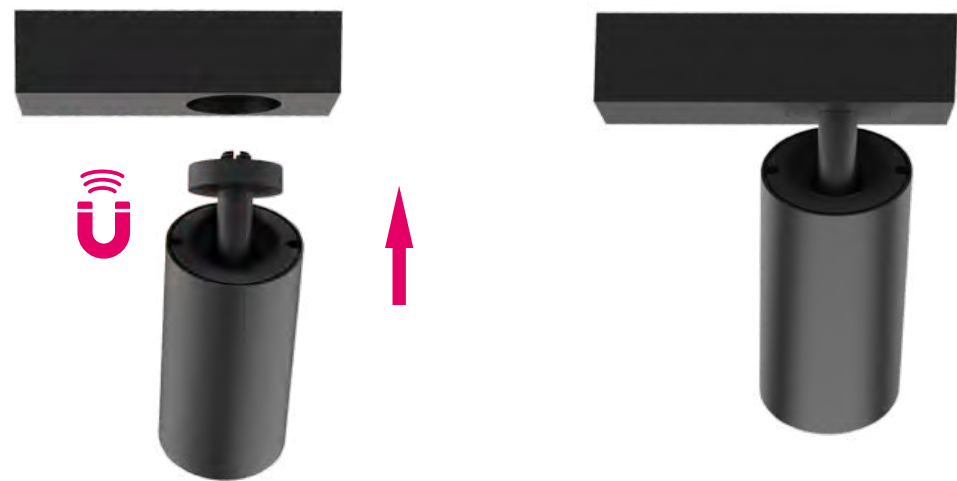
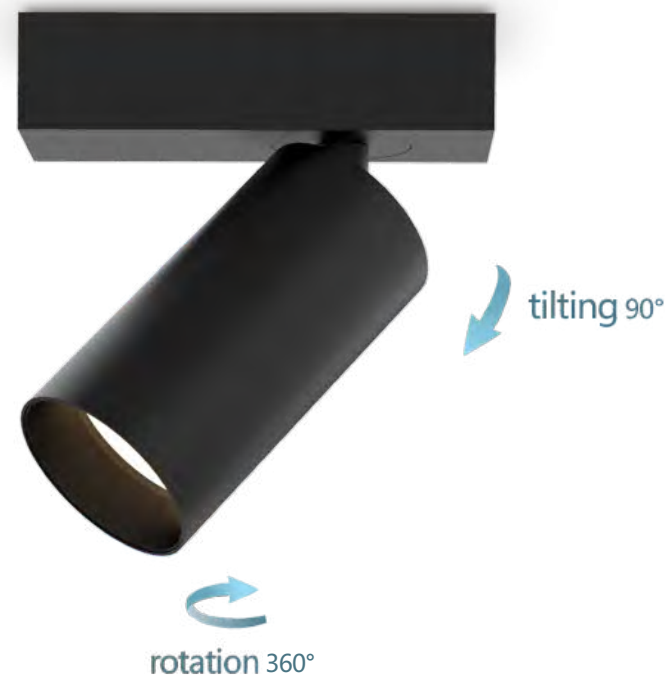

BREEZE SINGLE – Ceiling Mounted Soptlight

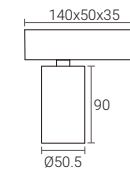

Quick Info

- Bridgelux LED: 7W, CRI>90
- CCT: 2700K Available as Standard
- Beam Angle: 36°
- Lumen Output: Up to 700lm System Luminous Flux
- IP Class: IP20
- LED Driver: Phase Dim

Light Distribution

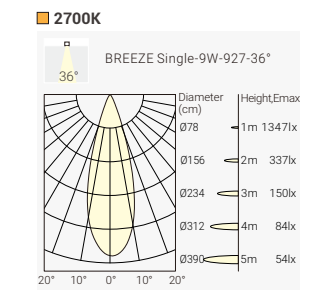

Finish



Order Info

LED Power	System Power	LED Voltage	LED Current	CRI	CCT	Beam	LED Output	System Output	Code
7W	9W	36V	200mA	90	2700K	36°	800lm	700lm	B1SC-9273609P-WB
7W	9W	36V	200mA	90	2700K	36°	800lm	700lm	B1SC-9273609P-BB

Code Remark: P=P(Phase Dim)

BREEZE DOUBLE – Ceiling Mounted S spotlight



Quick Info

- Bridgelux LED: 14W, CRI>90
- CCT: 2700K Available as Standard
- Beam Angle: 36°
- Lumen Output: Up to 1400lm System Luminous Flux
- IP Class: IP20
- LED Driver: Phase Dim

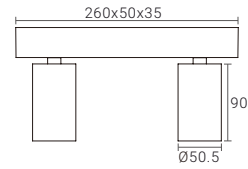

Light Distribution

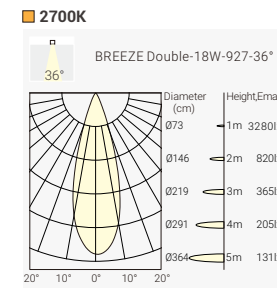

Finish



Order Info

LED Power	System Power	LED Voltage	LED Current	CRI	CCT	Beam	LED Output	System Output	Code
2x7W	2x9W	36V	2x200mA	90	2700K	36°	1600lm	1400lm	B2SC-9273618P-WB
2x7W	2x9W	36V	2x200mA	90	2700K	36°	1600lm	1400lm	B2SC-9273618P-BB

Code Remark: P=P(Phase Dim)

BREEZE TRIPLE – Ceiling Mounted S spotlight



Quick Info

- Bridgelux LED: 21W, CRI>90
- CCT: 2700K Available as Standard
- Beam Angle: 36°
- Lumen Output: Up to 2100lm System Luminous Flux
- IP Class: IP20
- LED Driver: Phase Dim

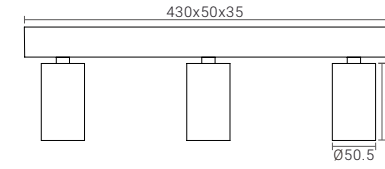

Light Distribution

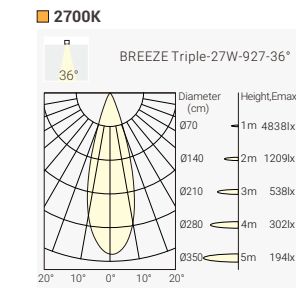

Finish



Order Info

LED Power	System Power	LED Voltage	LED Current	CRI	CCT	Beam	LED Output	System Output	Code
3x7W	3x9W	36V	3x200mA	90	2700K	36°	2400lm	2100lm	B3SC-9273627P-WB
3x7W	3x9W	36V	3x200mA	90	2700K	36°	2400lm	2100lm	B3SC-9273627P-BB

Code Remark: P=P(Phase Dim)

VIBES



Tilting 90°

Rotation 360°



Different Mounting Bases (White/ Black)

Surface Mounted



1RC Base



1SC Base



2RC Base



2SC Base

Recessed Mounted



1RR Base



1SR Base



2RR Base



2SR Base

Accessory



Honeycomb

Module Color



Black



Brushed Gold



Chrome



White

VIBES V1RC – Single-Head Ceiling Mounted Spotlight



Quick Info

- CITIZEN LED: 14W, CRI>90
- CCT: 2700K, 3000K Available as Standard
- Beam Angle: 36°
- Lumen Output: Up to 1200lm System Luminous Flux
- IP Class: IP20
- LED Driver: Phase Dim

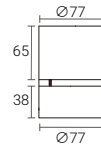

Light Distribution

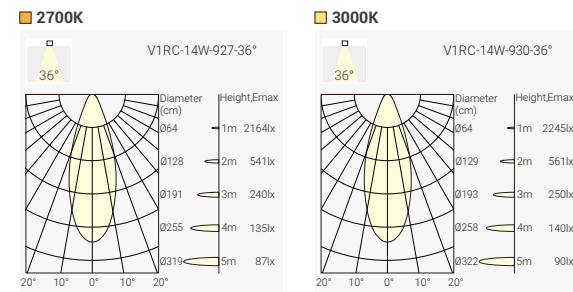

Finish



Order Info (VIBES V1RC in White-White Finish as an Example)

LED Power	System Power	LED Voltage	LED Current	CRI	CCT	Beam	LED Output	System Output	Code
12.5W	14W	36V	350mA	90	2700K	36°	1400lm	1100lm	V1RC-9273614P-WW
					3000K	36°	1500lm	1200lm	V1RC-9303614P-WW

Code Remark: P=P(Phase Dim)

Coding

V1RC - *** ** ** * - ** - *

Model	CRI/ CCT	Beam Angle	Power	Control	Finish	Accessory
V1RC	927 CRI90/ 2700K	36°	14 14W	P Phase Dim	WW White-White (WW)	H Honeycomb
	930 CRI90/ 3000K				BB Black-Black (BB)	
					BC Black-Chrome (BC)	
					BG Black-Gold (BG)	

Optional accessory

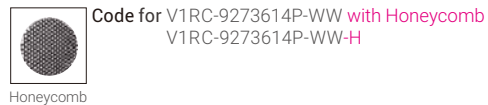

VIBES V2RC – Double-Head Ceiling Mounted Spotlight



Quick Info

- CITIZEN LED: 28W, CRI>90
- CCT: 2700K, 3000K Available as Standard
- Beam Angle: 36°
- Lumen Output: Up to 2400lm System Luminous Flux
- IP Class: IP20
- LED Driver: Phase Dim

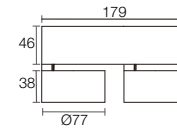

Light Distribution

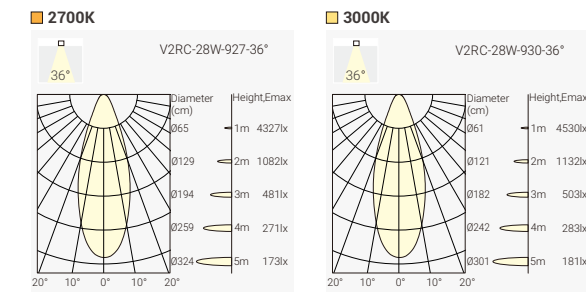

Finish



Order Info (VIBES V2RC in White-White Finish as an Example)

LED Power	System Power	LED Voltage	LED Current	CRI	CCT	Beam	LED Output	System Output	Code
2x12.5W	2x14W	36V	2x350mA	90	2700K	36°	2900lm	2300lm	V2RC-9273628P-WW
					3000K	36°	3000lm	2400lm	V2RC-9303628P-WW

Code Remark: P=P(Phase Dim)

Coding

V2RC - *** ** ** * - ** - *

Model	CRI/ CCT	Beam Angle	Power	Control	Finish	Accessory
V2RC	927 CRI90/ 2700K	36°	28 28W	P Phase Dim	WW White-White (WW)	H Honeycomb
	930 CRI90/ 3000K				BB Black-Black (BB)	
					BC Black-Chrome (BC)	
					BG Black-Gold (BG)	

Optional accessory

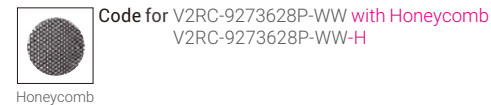

VIBES V1SC – Single-Head Ceiling Mounted Spotlight



Quick Info

- CITIZEN LED: 14W, CRI>90
- CCT: 2700K, 3000K Available as Standard
- Beam Angle: 36°
- Lumen Output: Up to 1200lm System Luminous Flux
- IP Class: IP20
- LED Driver: Phase Dim

Light Distribution

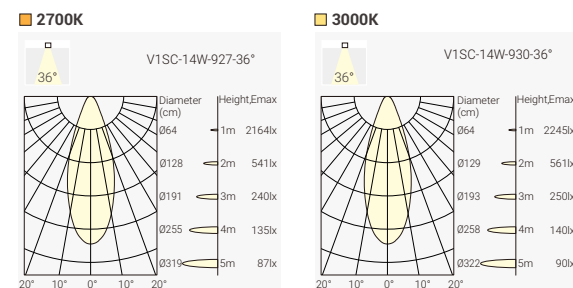
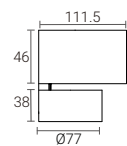

Base Finish



Order Info (VIBES V1SC in White-White Finish as an Example)

LED Power	System Power	LED Voltage	LED Current	CRI	CCT	Beam	LED Output	System Output	Code
12.5W	14W	36V	350mA	90	2700K	36°	1400lm	1100lm	V1SC-9273614P-WW
					3000K	36°	1500lm	1200lm	V1SC-9303614P-WW

Code Remark: P=P(Phase Dim)

Coding

V1SC - *** ** ** * - ** - *

Model	CRI/ CCT	Beam Angle	Power	Control	Finish	Accessory
V1SC	927 CRI90/ 2700K	36°	14 14W	P Phase Dim	WW White-White (WW)	H Honeycomb
	930 CRI90/ 3000K				BB Black-Black (BB)	
					BC Black-Chrome (BC)	
					BG Black-Gold (BG)	

Optional accessory



Honeycomb

Code for V1SC-9273614P-WW with Honeycomb
V1SC-9273614P-WW-H

VIBES V2SC – Double-Head Ceiling Mounted Spotlight



Quick Info

- CITIZEN LED: 28W, CRI>90
- CCT: 2700K, 3000K Available as Standard
- Beam Angle: 36°
- Lumen Output: Up to 2400lm System Luminous Flux
- IP Class: IP20
- LED Driver: Phase Dim

Light Distribution

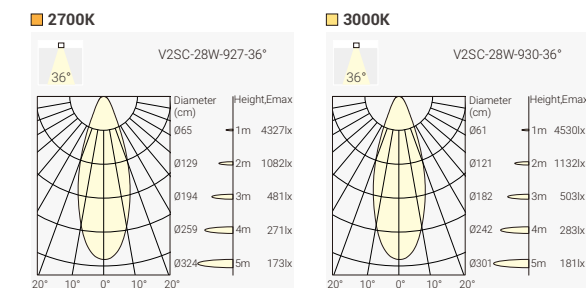
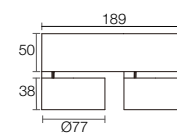

Base Finish



Order Info (VIBES V2SC in White-White Finish as an Example)

LED Power	System Power	LED Voltage	LED Current	CRI	CCT	Beam	LED Output	System Output	Code
2x12.5W	2x14W	36V	2x350mA	90	2700K	36°	2900lm	2300lm	V2SC-9273628P-WW
					3000K	36°	3000lm	2400lm	V2SC-9303628P-WW

Code Remark: P=P(Phase Dim)

Coding

V2SC - *** ** ** * - ** - *

Model	CRI/ CCT	Beam Angle	Power	Control	Finish	Accessory
V2SC	927 CRI90/ 2700K	36°	28 28W	P Phase Dim	WW White-White (WW)	H Honeycomb
	930 CRI90/ 3000K				BB Black-Black (BB)	
					BC Black-Chrome (BC)	
					BG Black-Gold (BG)	

Optional accessory



Honeycomb

Code for V2SC-9273628P-WW with Honeycomb
V2SC-9273628P-WW-H

VIBES V1RR – Single-Head Recessed Spotlight



Quick Info

- CITIZEN LED: 14W, CRI>90
- CCT: 2700K, 3000K Available as Standard
- Beam Angle: 36°
- Lumen Output: Up to 1200lm System Luminous Flux
- IP Class: IP20
- LED Driver: Phase Dim, DALI Dim, Casambi Wireless Dim

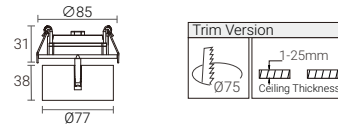

Light Distribution

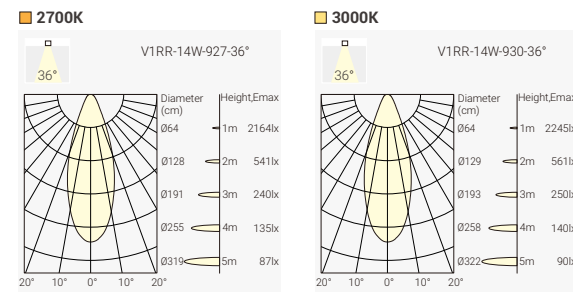

Finish



Order Info (VIBES V1RR in White-White Finish as an Example)

LED Power	System Power	LED Voltage	LED Current	CRI	CCT	Beam	LED Output	System Output	Code
12.5W	14W	36V	350mA	90	2700K	36°	1400lm	1100lm	V1RR-9273614P-WW
					3000K	36°	1500lm	1200lm	V1RR-9303614P-WW

Code Remark: P=P(Phase Dim)

Coding

V1RR - *** ** ** * - ** - *

Model	CRI/ CCT	Beam Angle	Power	Control	Finish	Accessory
V1RR	927 CRI90/ 2700K	36	14	P Phase Dim	WW White-White (WW)	H Honeycomb
	930 CRI90/ 3000K			D DALI Dim	BB Black-Black (BB)	
					BC Black-Chrome (BC)	
					BG Black-Gold (BG)	

Optional accessory

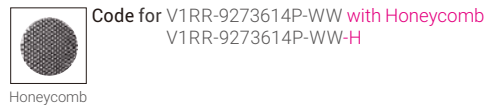

VIBES V2RR – Double-Head Recessed Spotlight



Quick Info

- CITIZEN LED: 28W, CRI>90
- CCT: 2700K, 3000K Available as Standard
- Beam Angle: 36°
- Lumen Output: Up to 2400lm System Luminous Flux
- IP Class: IP20
- LED Driver: Phase Dim, DALI Dim, Casambi Wireless Dim

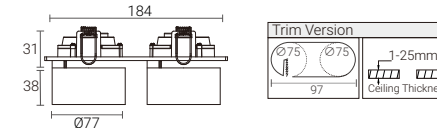

Light Distribution

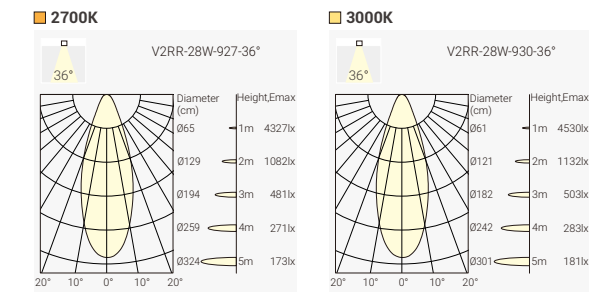

Finish



Order Info (VIBES V2RR in White-White Finish as an Example)

LED Power	System Power	LED Voltage	LED Current	CRI	CCT	Beam	LED Output	System Output	Code
2x12.5W	2x14W	36V	2x350mA	90	2700K	36°	2900lm	2300lm	V2RR-9273628P-WW
					3000K	36°	3000lm	2400lm	V2RR-9303628P-WW

Code Remark: P=P(Phase Dim)

Coding

V2RR - *** ** ** * - ** - *

Model	CRI/ CCT	Beam Angle	Power	Control	Finish	Accessory
V2RR	927 CRI90/ 2700K	36	28	P Phase Dim	WW White-White (WW)	H Honeycomb
	930 CRI90/ 3000K			D DALI Dim	BB Black-Black (BB)	
					BC Black-Chrome (BC)	
					BG Black-Gold (BG)	

Optional accessory

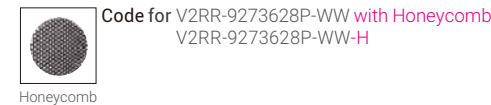

VIBES V1SR – Single-Head Recessed Spotlight



Quick Info

- CITIZEN LED: 14W, CRI>90
- CCT: 2700K, 3000K Available as Standard
- Beam Angle: 36°
- Lumen Output: Up to 1200lm System Luminous Flux
- IP Class: IP20
- LED Driver: Phase Dim, DALI Dim, Casambi Wireless Dim

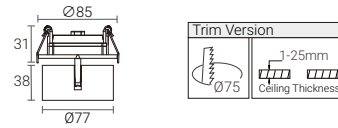

Light Distribution

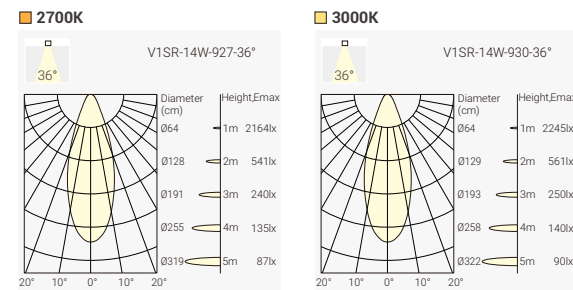

Finish



Order Info (VIBES V1SR in White-White Finish as an Example)

LED Power	System Power	LED Voltage	LED Current	CRI	CCT	Beam	LED Output	System Output	Code
12.5W	14W	36V	350mA	90	2700K	36°	1400lm	1100lm	V1SR-9273614P-WW
					3000K	36°	1500lm	1200lm	V1SR-9303614P-WW

Code Remark: P=P(Phase Dim)

Coding

V1SR - *** ** ** * - ** - *

Model	CRI/ CCT	Beam Angle	Power	Control	Finish	Accessory
V1SR	927 CRI90/ 2700K	36°	14 14W	P Phase Dim	WW White-White (WW)	H Honeycomb
	930 CRI90/ 3000K			D DALI Dim	BB Black-Black (BB)	
					BC Black-Chrome (BC)	
					BG Black-Gold (BG)	

Optional accessory

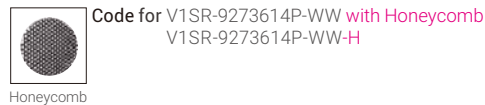

VIBES V2SR – Double-Head Recessed Spotlight



Quick Info

- CITIZEN LED: 28W, CRI>90
- CCT: 2700K, 3000K Available as Standard
- Beam Angle: 36°
- Lumen Output: Up to 2400lm System Luminous Flux
- IP Class: IP20
- LED Driver: Phase Dim, DALI Dim, Casambi Wireless Dim

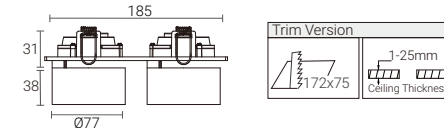

Light Distribution

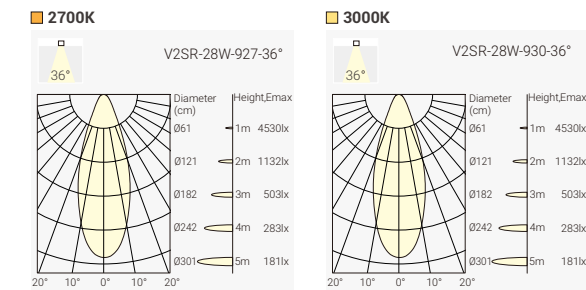

Finish



Order Info (VIBES V2SR in White-White Finish as an Example)

LED Power	System Power	LED Voltage	LED Current	CRI	CCT	Beam	LED Output	System Output	Code
2x12.5W	2x14W	36V	2x350mA	90	2700K	36°	2900lm	2300lm	V2SR-9273628P-WW
					3000K	36°	3000lm	2400lm	V2SR-9303628P-WW

Code Remark: P=P(Phase Dim)

Coding

V2SR - *** ** ** * - ** - *

Model	CRI/ CCT	Beam Angle	Power	Control	Finish	Accessory
V2SR	927 CRI90/ 2700K	36°	28 28W	P Phase Dim	WW White-White (WW)	H Honeycomb
	930 CRI90/ 3000K			D DALI Dim	BB Black-Black (BB)	
					BC Black-Chrome (BC)	
					BG Black-Gold (BG)	

Optional accessory

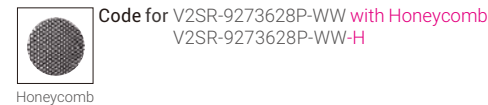

PURE-C

Ceiling Mounted Spotlight
Integrated LED Driver
No Visible Screw



PURE Art-C – Ceiling Mounted Spotlight

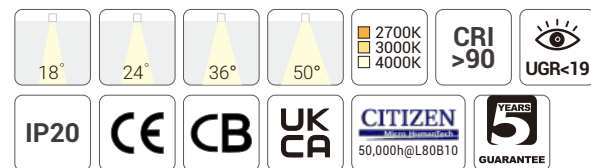

Quick Info

- CITIZEN LED: 15W, CRI>90
- CCT: 2700K, 3000K, 4000K Available as Standard
- Beam Angle: 18°, 24°, 36°, 50°
- Lumen Output: Up to 1000lm System Luminous Flux
- IP Class: IP20
- LED Driver: On-Off, Phase Dim

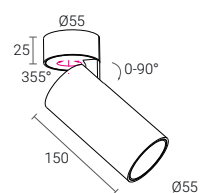

Light Distribution

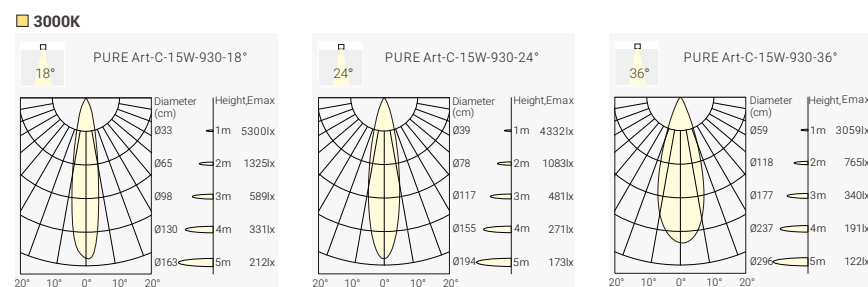

Finish



Order Info (PURE Art-C in White Housing & Black Reflector as an Example)

LED Power	System Power	LED Voltage	LED Current	CRI	CCT	Beam	LED Output	System Output	Code
13W	15W	36V	350mA	90	2700K	18°	850lm	900lm	PUAC-9271815F-WB
						24°	1100lm	900lm	PUAC-9272415F-WB
						36°	1100lm	900lm	PUAC-9273615F-WB
						50°	1100lm	900lm	PUAC-9275015F-WB
					3000K	18°	1200lm	950lm	PUAC-9301815F-WB
						24°	1200lm	950lm	PUAC-9302415F-WB
						36°	1200lm	950lm	PUAC-9303615F-WB
						50°	1200lm	950lm	PUAC-9305015F-WB
					4000K	18°	1300lm	1000lm	PUAC-9401815F-WB
						24°	1300lm	1000lm	PUAC-9402415F-WB
						36°	1300lm	1000lm	PUAC-9403615F-WB
						50°	1300lm	1000lm	PUAC-9405015F-WB

Code Remark: F=F(ON-OFF) P=P(Phase Dim)

Coding

Model	CRI/ CCT	Beam Angle	Power	Control	Finish	Reflector Color	Accessory
PUAC PURE Art-C	927 CRI90/ 2700K	18° 18°	15 15W	F On-Off	W White	B Black	H Honeycomb
	930 CRI90/3000K	24° 24°		P Phase Dim	B Black		
	940 CRI90/ 4000K	36° 36°					
		50° 50°					

Optional accessory

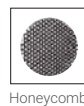

Code for PUAC-9302511F-WB with Honeycomb
PUAC-9302511F-WB-H

PURE S-C – Ceiling Mounted Spotlight

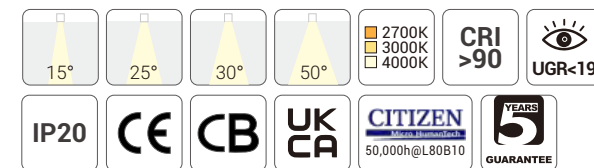

Quick Info

- CITIZEN LED: 15W, 21W, CRI>90
- CCT: 2700K, 3000K, 4000K Available as Standard
- Beam Angle: 15°, 25°, 30°, 50°
- Lumen Output: Up to 1700lm System Luminous Flux
- IP Class: IP20
- LED Driver: On-Off, Phase Dim, DALI Dim

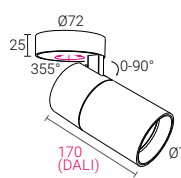
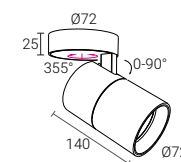

Light Distribution

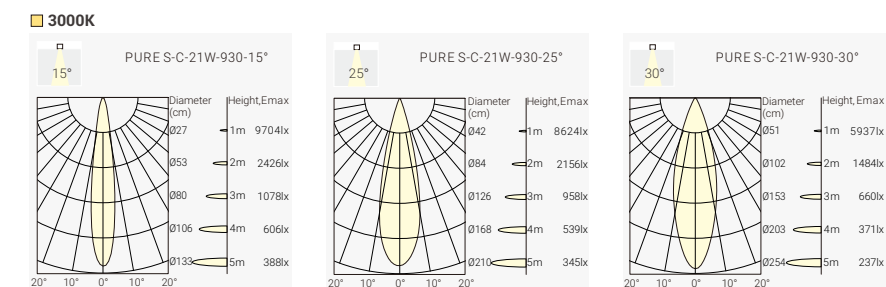

Finish



Order Info (PURE S-C in White Housing & Black Reflector as an Example)

LED Power	System Power	LED Voltage	LED Current	CRI	CCT	Beam	LED Output	System Output	Code
13W	15W	36V	250mA	90	2700K	15°	1400lm	1100lm	PUSC-9271509F-WB
						25°	1400lm	1100lm	PUSC-9272509F-WB
						30°	1400lm	1100lm	PUSC-9273009F-WB
						50°	1400lm	850lm	PUSC-9275009F-WB
					3000K	15°	1500lm	1200lm	PUSC-9301509F-WB
						25°	1500lm	1200lm	PUSC-9302509F-WB
						30°	1500lm	1200lm	PUSC-9303009F-WB
						50°	1500lm	900lm	PUSC-9305009F-WB
					4000K	15°	1600lm	1300lm	PUSC-9401509F-WB
						25°	1600lm	1300lm	PUSC-9402509F-WB
						30°	1600lm	1300lm	PUSC-9403009F-WB
						50°	1600lm	1000lm	PUSC-9405009F-WB
18W	21W	36V	500mA	90	2700K	15°	1900lm	1500lm	PUSC-9271513F-WB
						25°	1900lm	1500lm	PUSC-9272513F-WB
						30°	1900lm	1500lm	PUSC-9273013F-WB
						50°	1900lm	1100lm	PUSC-9275013F-WB
					3000K	15°	2000lm	1600lm	PUSC-9301513F-WB
						25°	2000lm	1600lm	PUSC-9302513F-WB
						30°	2000lm	1600lm	PUSC-9303013F-WB
						50°	2000lm	1200lm	PUSC-9305013F-WB
					4000K	15°	2100lm	1700lm	PUSC-9401513F-WB
						25°	2100lm	1700lm	PUSC-9402513F-WB
						30°	2100lm	1700lm	PUSC-9403013F-WB
						50°	2100lm	1300lm	PUSC-9405013F-WB

Code Remark: F=F(ON-OFF) P=P(Phase Dim) D=D(DALI Dim)

Optional accessory

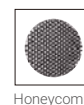

Code for PUSC-9302515F-WB with Honeycomb
PUSC-9302515F-WB-H

Coding

Model	CRI/ CCT	Beam Angle	Power	Control	Finish	Reflector Color	Accessory
PUSC PURE S-C	927 CRI90/ 2700K	15° 15°	15 15W	F On-Off	W White	B Black	H Honeycomb
	930 CRI90/3000K	25° 25°	21 21W	P Phase Dim	B Black		
	940 CRI90/ 4000K	30° 30°		D DALI Dim			
		50° 50°					

PURE

LED Tracklight
Integrated LED Driver
Elegant Design



Project: VALO Hotel Helsinki, Finland

PURE – LED Tracklight

Project: HSG Perfumery Stuttgart Airport, Germany





Project: Peled Studios, Israel



Project: Maserati Showroom, Sofia, Bulgaria



Project: Sara Kulturhu, Norway



PURE Art – LED Tracklight

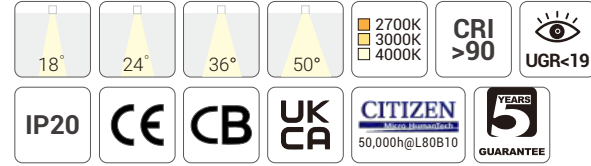

Quick Info

- CITIZEN LED: 11W, 15W, CRI>90
- CCT: 2700K, 3000K, 4000K Available as Standard
- Beam Angle: 18°, 24°, 36°, 50°
- Lumen Output: Up to 1000lm System Luminous Flux
- IP Class: IP20
- LED Driver: On-Off, Phase Dim

Light Distribution

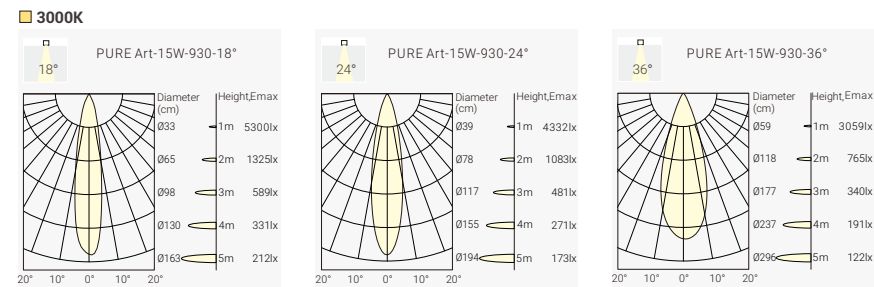

Finish



Order Info (PURE Art in White Housing & Black Reflector as an Example)

LED Power	System Power	LED Voltage	LED Current	CRI	CCT	Beam	LED Output	System Output	Code	
9W	11W	36V	250mA	90	2700K	18°	850lm	640lm	PUA2-9271811F-WB	
						24°	850lm	640lm	PUA2-9272411F-WB	
						36°	850lm	640lm	PUA2-9273611F-WB	
						50°	850lm	640lm	PUA2-9275011F-WB	
						3000K	18°	950lm	720lm	PUA2-9301811F-WB
							24°	950lm	720lm	PUA2-9302411F-WB
							36°	850lm	720lm	PUA2-9303611F-WB
							50°	850lm	720lm	PUA2-9305011F-WB
						4000K	18°	1050lm	800lm	PUA2-9401811F-WB
							30°	1050lm	800lm	PUA2-9402411F-WB
							36°	1050lm	800lm	PUA2-9403611F-WB
							50°	1050lm	800lm	PUA2-9405011F-WB
13W	15W	36V	350mA	90	2700K		18°	1100lm	900lm	PUA2-9271815F-WB
							24°	1100lm	900lm	PUA2-9272415F-WB
							36°	1100lm	900lm	PUA2-9273615F-WB
							50°	1100lm	900lm	PUA2-9275015F-WB
						3000K	18°	1200lm	950lm	PUA2-9301815F-WB
							24°	1200lm	950lm	PUA2-9302415F-WB
							36°	1200lm	950lm	PUA2-9303615F-WB
							50°	1200lm	950lm	PUA2-9305015F-WB
4000K	18°	1300lm	1000lm	PUA2-9401815F-WB						
	24°	1300lm	1000lm	PUA2-9402415F-WB						
	36°	1300lm	1000lm	PUA2-9403615F-WB						
	50°	1300lm	1000lm	PUA2-9405015F-WB						

Code Remark: F=F(ON-OFF) P=P(Phase Dim)

Coding

Model	CRI/ CCT	Beam Angle	Power	Control	Finish	Reflector Color	Accessory
PUA2 PURE Art	927 CRI90/ 2700K	18°	11 11W	F On-Off	W White	B Black	H Honeycomb
	930 CRI90/3000K	24°	15 15W	P Phase Dim	B Black		
	940 CRI90/ 4000K	36°					
		50°					
		50°					

Track System



Compatible with GLOBAL / POWERGEAR 3-Circuit Track System



Project: Hotel MouCo, Portugal

PURE S – LED Tracklight

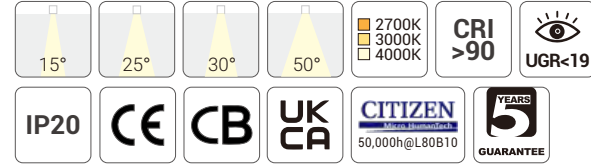

Quick Info

- CITIZEN LED: 15W, 21W, CRI>90
- CCT: 2700K, 3000K, 4000K Available as Standard
- Beam Angle: 15°, 25°, 30°, 50°
- Lumen Output: Up to 1700lm System Luminous Flux
- IP Class: IP20
- LED Driver: On-Off, Phase Dim

Light Distribution

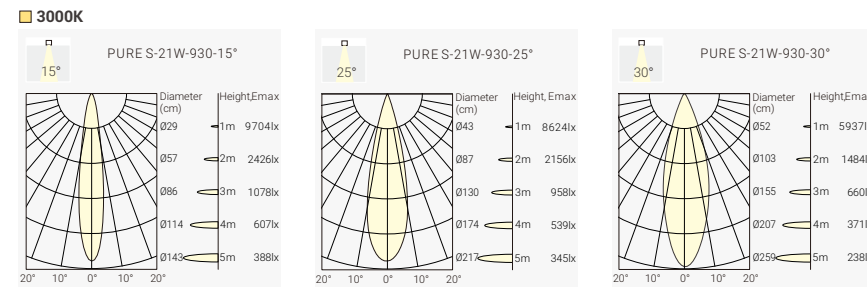
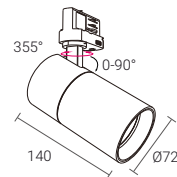

Finish



Order Info (PURE S in White Housing & Black Reflector as an Example)

LED Power	System Power	LED Voltage	LED Current	CRI	CCT	Beam	LED Output	System Output	Code	
13W	15W	36V	250mA	90	2700K	15°	1400lm	1100lm	PUS1-9271515F-WB	
						25°	1400lm	1100lm	PUS1-9272515F-WB	
						30°	1400lm	1100lm	PUS1-9273015F-WB	
						50°	1400lm	850lm	PUS1-9275015F-WB	
						3000K	15°	1500lm	1200lm	PUS1-9301515F-WB
							25°	1500lm	1200lm	PUS1-9302515F-WB
							30°	1500lm	1200lm	PUS1-9303015F-WB
							50°	1500lm	900lm	PUS1-9305015F-WB
						4000K	15°	1600lm	1300lm	PUS1-9401515F-WB
							25°	1600lm	1300lm	PUS1-9402515F-WB
							30°	1600lm	1300lm	PUS1-9403015F-WB
							50°	1600lm	1000lm	PUS1-9405015F-WB
18W	21W	36V	500mA	90	2700K	15°	1100lm	1500lm	PUS2-9271521F-WB	
						25°	1100lm	1500lm	PUS2-9272521F-WB	
						30°	1100lm	1500lm	PUS2-9273021F-WB	
						50°	1100lm	1100lm	PUS2-9275021F-WB	
						3000K	15°	1200lm	1600lm	PUS2-9301521F-WB
							25°	1200lm	1600lm	PUS2-9302521F-WB
							30°	1200lm	1600lm	PUS2-9303021F-WB
							50°	1200lm	1200lm	PUS2-9305021F-WB
						4000K	15°	1300lm	1700lm	PUS2-9401521F-WB
							25°	1300lm	1700lm	PUS2-9402521F-WB
							30°	1300lm	1700lm	PUS2-9403021F-WB
							50°	1300lm	1300lm	PUS2-9405021F-WB

Code Remark: F=F(ON-OFF) P=P(Phase Dim)

Coding

Model	CRI/ CCT	Beam Angle	Power	Control	Finish	Reflector Color	Accessory
PUS1 PURE S-15W	927 CRI90/ 2700K	15°	15W	F On-Off	W White	B Black	H Honeycomb
PUS2 PURE S-21W	930 CRI90/3000K	24°	21W	P Phase Dim	B Black		
		36°					
		50°					
		50°					

Track System

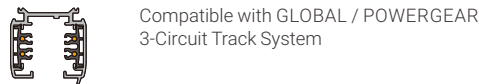

PURE S – LED Tracklight



Quick Info

- CITIZEN LED: 15W, 21W, CRI>90
- CCT: 2700K, 3000K, 4000K Available as Standard
- Beam Angle: 15°, 25°, 30°, 50°
- Lumen Output: Up to 1700lm System Luminous Flux
- IP Class: IP20
- LED Driver: DALI Dim

Light Distribution

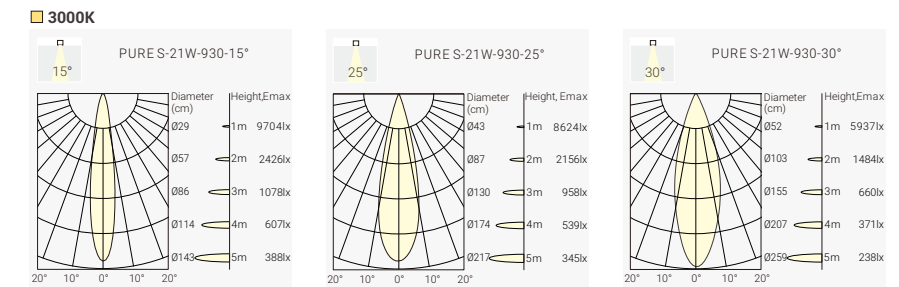
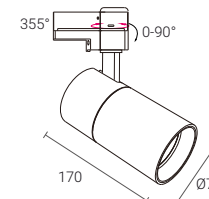

Finish



Order Info (PURE S in White Housing & Black Reflector as an Example)

LED Power	System Power	LED Voltage	LED Current	CRI	CCT	Beam	LED Output	System Output	Code	
13W	15W	36V	250mA	90	2700K	15°	1400lm	1100lm	PUS1-9271515D-WB	
						25°	1400lm	1100lm	PUS1-9272515D-WB	
						30°	1400lm	1100lm	PUS1-9273015D-WB	
						50°	1400lm	850lm	PUS1-9275015D-WB	
						3000K	15°	1500lm	1200lm	PUS1-9301515D-WB
							25°	1500lm	1200lm	PUS1-9302515D-WB
							30°	1500lm	1200lm	PUS1-9303015D-WB
							50°	1500lm	900lm	PUS1-9305015D-WB
						4000K	15°	1600lm	1300lm	PUS1-9401515D-WB
							25°	1600lm	1300lm	PUS1-9402515D-WB
							30°	1600lm	1300lm	PUS1-9403015D-WB
							50°	1600lm	1000lm	PUS1-9405015D-WB
18W	21W	36V	500mA	90	2700K	15°	1900lm	1500lm	PUS2-9271521D-WB	
						25°	1900lm	1500lm	PUS2-9272521D-WB	
						30°	1900lm	1500lm	PUS2-9273021D-WB	
						50°	1900lm	1100lm	PUS2-9275021D-WB	
						3000K	15°	2000lm	1600lm	PUS2-9301521D-WB
							25°	2000lm	1600lm	PUS2-9302521D-WB
							30°	2000lm	1600lm	PUS2-9303021D-WB
							50°	2000lm	1200lm	PUS2-9305021D-WB
						4000K	15°	2100lm	1700lm	PUS2-9401521D-WB
							25°	2100lm	1700lm	PUS2-9402521D-WB
							30°	2100lm	1700lm	PUS2-9403021D-WB
							50°	2100lm	1300lm	PUS2-9405021D-WB

Code Remark: D=D(DALI Dim)

Optional accessory

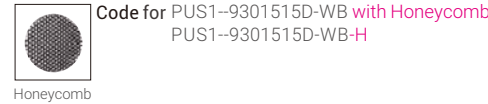

Code for PUS1-9301515D-WB with Honeycomb
PUS1-9301515D-WB-H

Track System

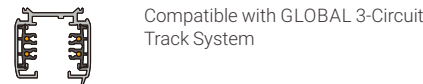

Coding

Model	CRI/ CCT	Beam Angle	Power	Control	Finish	Reflector Color	Accessory
PUS1 PURE S-15W	927 CRI90/ 2700K	15°	15W	D DALI DIM	W White	B Black	H Honeycomb
PUS2 PURE S-21W	930 CRI90/3000K	24°	21W		B Black		
		36°					
		50°					
		50°					

PURE M – LED Tracklight

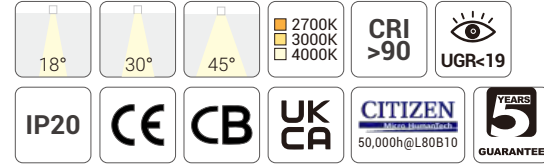

Quick Info

- CITIZEN LED: 28W, CRI>90
- CCT: 2700K, 3000K, 4000K Available as Standard
- Beam Angle: 18°, 30°, 45°
- Lumen Output: Up to 2900lm System Luminous Flux
- IP Class: IP20
- LED Driver: On-Off

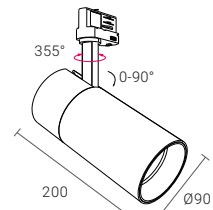

Light Distribution

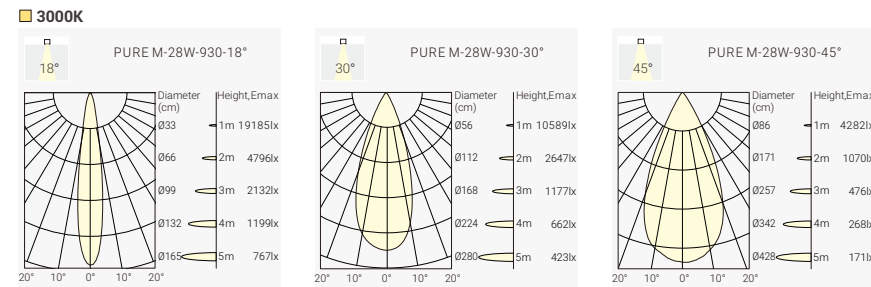

Finish



Order Info (PURE M in White Housing & Black Reflector as an Example)

LED Power	System Power	LED Voltage	LED Current	CRI	CCT	Beam	LED Output	System Output	Code	
25W	28W	36V	700mA	90	2700K	18°	3200lm	2500lm	PUM1-9271828F-WB	
						30°	3200lm	2500lm	PUM1-9273028F-WB	
						45°	3200lm	2500lm	PUM1-9274528F-WB	
						3000K	18°	3400lm	2700lm	PUM1-9301828F-WB
							30°	3400lm	2700lm	PUM1-9303028F-WB
							45°	3400lm	2700lm	PUM1-9304528F-WB
						4000K	18°	3600lm	2900lm	PUM1-9401828F-WB
							30°	3600lm	2900lm	PUM1-9403028F-WB
							45°	3600lm	2900lm	PUM1-9404528F-WB

Code Remark: F=F(ON-OFF)

Coding

PUM1 - *** ** * - * * - *

Model	CRI/ CCT	Beam Angle	Power	Control	Finish	Reflector Color	Accessory
PUM1 PURE M	927 CRI90/ 2700K	18°	28 28W	F On-Off	W White	B Black	H Honeycomb
	930 CRI90/3000K	30°			B Black		
	940 CRI90/ 4000K	45°					

Optional accessory

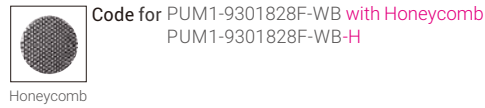

Track System

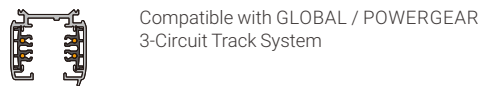

PURE M – LED Tracklight



Quick Info

- CITIZEN LED: 28W, CRI>90
- CCT: 2700K, 3000K, 4000K Available as Standard
- Beam Angle: 18°, 30°, 45°
- Lumen Output: Up to 2900lm System Luminous Flux
- IP Class: IP20
- LED Driver: DALI Dim

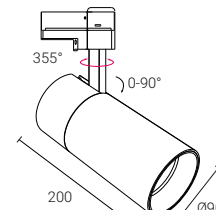

Light Distribution

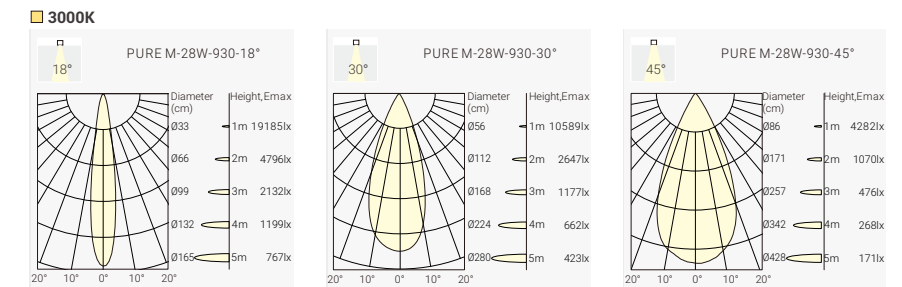

Finish



Order Info

LED Power	System Power	LED Voltage	LED Current	CRI	CCT	Beam	LED Output	System Output	Code	
25W	28W	36V	700mA	90	2700K	18°	3200lm	2500lm	PUM1-9271828D-WB	
						30°	3200lm	2500lm	PUM1-9273028D-WB	
						45°	3200lm	2500lm	PUM1-9274528D-WB	
						3000K	18°	3400lm	2700lm	PUM1-9301828D-WB
							30°	3400lm	2700lm	PUM1-9303028D-WB
							45°	3400lm	2700lm	PUM1-9304528D-WB
						4000K	18°	3600lm	2900lm	PUM1-9401828D-WB
							30°	3600lm	2900lm	PUM1-9403028D-WB
							45°	3600lm	2900lm	PUM1-9404528D-WB

Code Remark: D=D(DALI Dim)

Optional accessory

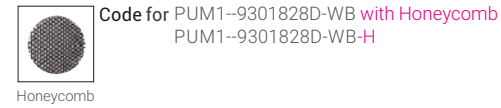

Track System

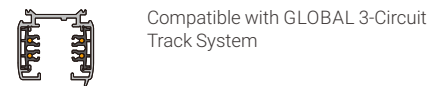

Coding

PUM1 - *** ** * - * * - *

Model	CRI/ CCT	Beam Angle	Power	Control	Finish	Reflector Color	Accessory
PUM1 PURE M	927 CRI90/ 2700K	18°	28 28W	D DALI DIM	W White	B Black	H Honeycomb
	930 CRI90/3000K	30°			B Black		
	940 CRI90/ 4000K	45°					

ROXY

In-track Driver LED Tracklight
Clean Design





Project: Clever armaturval för Kv Poolen, Sweden

ROXY – In-track Driver LED Tracklight

Project: CMS LAW FIRM, Poland



ROXY Art – In-track Driver LED Tracklight

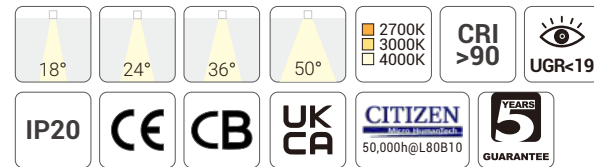

Quick Info

- CITIZEN LED: 15W, CRI>90
- CCT: 2700K, 3000K, 4000K Available as Standard
- Beam Angle: 18°, 24°, 36°, 50°
- Lumen Output: Up to 1000lm System Luminous Flux
- IP Class: IP20
- LED Driver: On-Off

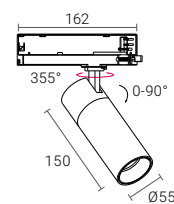

Light Distribution

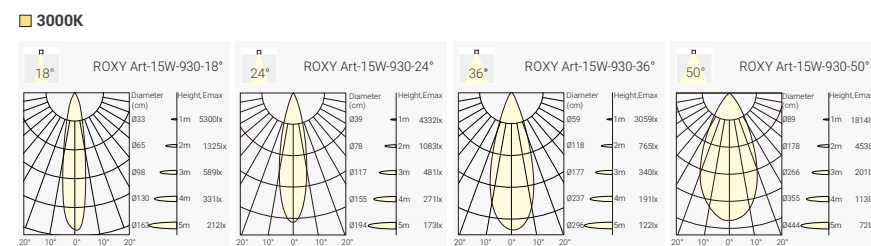

Finish



Order Info (ROXY Art in White Housing & Black Reflector as an Example)

LED Power	System Power	LED Voltage	LED Current	CRI	CCT	Beam	LED Output	System Output	Code
13W	15W	36V	350mA	90	2700K	18°	1200lm	900lm	ROA1-9271815F-WB
						24°	1200lm	900lm	ROA1-9272415F-WB
						36°	1200lm	900lm	ROA1-9273615F-WB
						50°	1200lm	900lm	ROA1-9275015F-WB
					3000K	18°	1300lm	950lm	ROA1-9301815F-WB
						24°	1300lm	950lm	ROA1-9302415F-WB
						36°	1300lm	950lm	ROA1-9303615F-WB
						50°	1300lm	950lm	ROA1-9305015F-WB
					4000K	18°	1400lm	1000lm	ROA1-9401815F-WB
						24°	1400lm	1000lm	ROA1-9402415F-WB
						36°	1400lm	1000lm	ROA1-9403615F-WB
						50°	1400lm	1000lm	ROA1-9405015F-WB

Code Remark F=F(ON-OFF)

Optional accessory

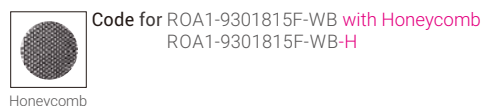

Track System

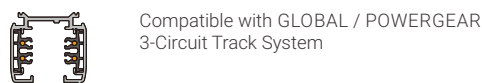

Coding

ROA1 - *** ** * - * * - *

Model	CRI/ CCT	Beam Angle	Power	Control	Finish	Reflector Color	Accessory
ROA1	927	18	15	F	W	B	H
ROXY Art	CRI90/ 2700K	18°	15W	On-Off	White	Black	Honeycomb
	930	24			B		
	CRI90/3000K	24°			Black		
	940	36					
	CRI90/ 4000K	36°					
		50					
		50°					

ROXY Art – In-track Driver LED Tracklight

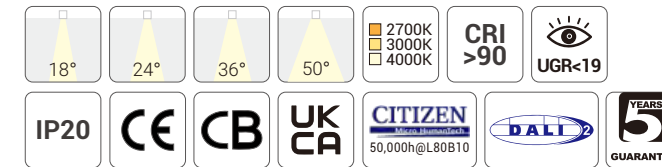

Quick Info

- CITIZEN LED: 15W, CRI>90
- CCT: 2700K, 3000K, 4000K Available as Standard
- Beam Angle: 18°, 24°, 36°, 50°
- Lumen Output: Up to 1000lm System Luminous Flux
- IP Class: IP20
- LED Driver: DALI Dim

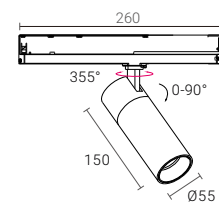

Light Distribution

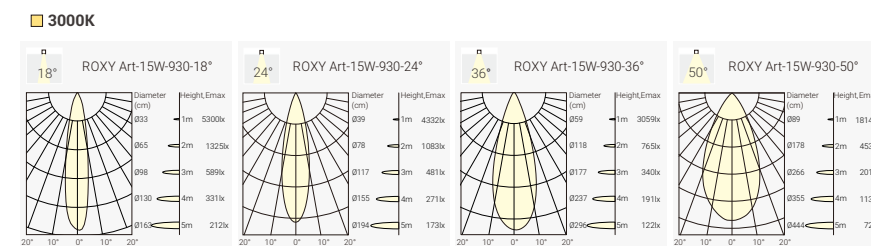

Finish



Order Info (ROXY Art in White Housing & Black Reflector as an Example)

LED Power	System Power	LED Voltage	LED Current	CRI	CCT	Beam	LED Output	System Output	Code
13W	15W	36V	350mA	90	2700K	18°	1200lm	900lm	ROA1-9271815D-WB
						24°	1200lm	900lm	ROA1-9272415D-WB
						36°	1200lm	900lm	ROA1-9273615D-WB
						50°	1200lm	900lm	ROA1-9275015D-WB
					3000K	18°	1300lm	950lm	ROA1-9301815D-WB
						24°	1300lm	950lm	ROA1-9302415D-WB
						36°	1300lm	950lm	ROA1-9303615D-WB
						50°	1300lm	950lm	ROA1-9305015D-WB
					4000K	18°	1400lm	1000lm	ROA1-9401815D-WB
						24°	1400lm	1000lm	ROA1-9402415D-WB
						36°	1400lm	1000lm	ROA1-9403615D-WB
						50°	1400lm	1000lm	ROA1-9405015D-WB

Code Remark D=D(DALI Dim)

Optional accessory

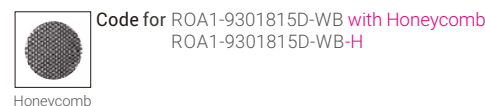

Track System

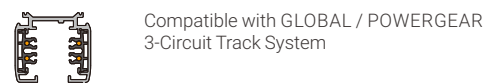

Coding

ROA1 - *** ** * - * * - *

Model	CRI/ CCT	Beam Angle	Power	Control	Finish	Reflector Color	Accessory
ROA1	927	18	15	D	W	B	H
ROXY Art	CRI90/ 2700K	18°	15W	DALI Dim	White	Black	Honeycomb
	930	24			B		
	CRI90/3000K	24°			Black		
	940	36					
	CRI90/ 4000K	36°					
		50					
		50°					

ROXY S – In-track Driver LED Tracklight

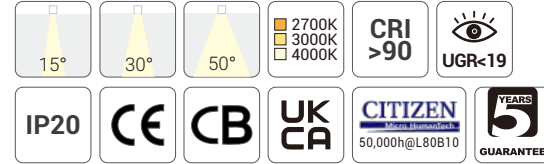

Quick Info

- CITIZEN LED: 15W, 21W, CRI>90
- CCT: 2700K, 3000K, 4000K Available as Standard
- Beam Angle: 15°, 30°, 50°
- Lumen Output: Up to 1700lm System Luminous Flux
- IP Class: IP20
- LED Driver: On-Off

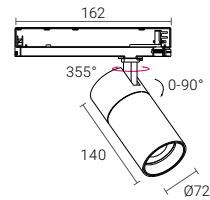

Light Distribution

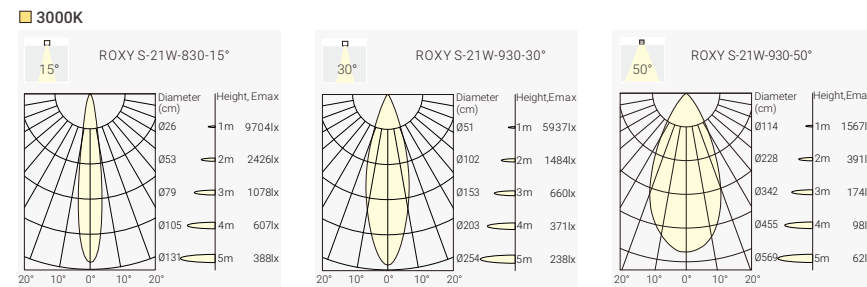

Finish



Order Info (ROXY S in White Housing & Black Reflector as an Example)

LED Power	System Power	LED Voltage	LED Current	CRI	CCT	Beam	LED Output	System Output	Code						
13W	15W	36V	250mA	90	2700K	15°	1400lm	1100lm	ROS1-9271515F-WB						
						30°	1400lm	1100lm	ROS1-9273015F-WB						
						50°	1400lm	850lm	ROS1-9275015F-WB						
						3000K	15°	1500lm	1200lm	ROS1-9301515F-WB					
							30°	1500lm	1200lm	ROS1-9303015F-WB					
							50°	1500lm	900lm	ROS1-9305015F-WB					
						4000K	15°	1600lm	1300lm	ROS1-9401515F-WB					
							30°	1600lm	1300lm	ROS1-9403015F-WB					
							50°	1600lm	1000lm	ROS1-9405015F-WB					
						18W	21W	36V	500mA	90	2700K	15°	1900lm	1500lm	ROS2-9271521F-WB
												30°	1900lm	1500lm	ROS2-9273021F-WB
												50°	1900lm	1100lm	ROS2-9275021F-WB
3000K	15°	2000lm	1600lm	ROS2-9301512F-WB											
	30°	2000lm	1600lm	ROS2-9303012F-WB											
	50°	2000lm	1100lm	ROS2-9305021F-WB											
4000K	15°	2100lm	1700lm	ROS2-9401512F-WB											
	30°	2100lm	1700lm	ROS2-9403012F-WB											
	50°	2100lm	1300lm	ROS2-9405021F-WB											

Code Remark: F=F(ON-OFF)

Optional accessory

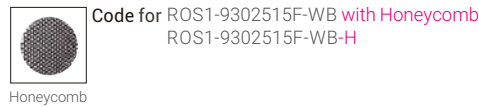

Track System

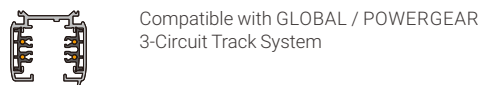

Coding

Model	CRI/ CCT	Beam Angle	Power	Control	Finish	Reflector Color	Accessory
ROS1	927	15	15	F	W	B	H
ROXY S-15W	CRI90/ 2700K	15°	15W	On-Off	White	Black	Honeycomb
ROS2	930	30	21		B		
ROXY S-21W	CRI90/3000K	30°	21W		Black		
	940	50					
	CRI90/ 4000K	50°					

ROXY S – In-track Driver LED Tracklight



Quick Info

- CITIZEN LED: 15W, 21W, CRI>90
- CCT: 2700K, 3000K, 4000K Available as Standard
- Beam Angle: 15°, 30°, 50°
- Lumen Output: Up to 1700lm System Luminous Flux
- IP Class: IP20
- LED Driver: DALL Dim

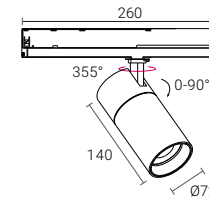

Light Distribution

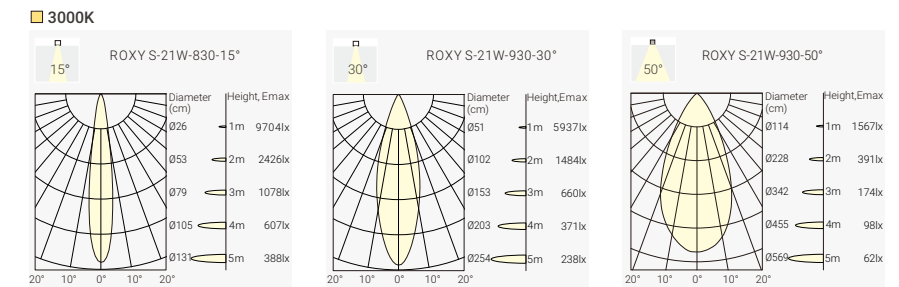

Finish



Order Info (ROXY S in White Housing & Black Reflector as an Example)

LED Power	System Power	LED Voltage	LED Current	CRI	CCT	Beam	LED Output	System Output	Code						
13W	15W	36V	250mA	90	2700K	15°	1400lm	1100lm	ROS1-9271515D-WB						
						30°	1400lm	1100lm	ROS1-9273015D-WB						
						50°	1400lm	850lm	ROS1-9275015D-WB						
						3000K	15°	1500lm	1200lm	ROS1-9301515D-WB					
							30°	1500lm	1200lm	ROS1-9303015D-WB					
							50°	1500lm	900lm	ROS1-9305015D-WB					
						4000K	15°	1600lm	1300lm	ROS1-9401515D-WB					
							30°	1600lm	1300lm	ROS1-9403015D-WB					
							50°	1600lm	1000lm	ROS1-9405015D-WB					
						18W	21W	36V	500mA	90	2700K	15°	1900lm	1500lm	ROS2-9271521D-WB
												30°	1900lm	1500lm	ROS2-9273021D-WB
												50°	1900lm	1500lm	ROS2-9275021D-WB
3000K	15°	2000lm	1600lm	ROS2-9301512D-WB											
	30°	2000lm	1600lm	ROS2-9303012D-WB											
	50°	2000lm	1500lm	ROS2-9305021D-WB											
4000K	15°	2100lm	1700lm	ROS2-9401512D-WB											
	30°	2100lm	1700lm	ROS2-9403012D-WB											
	50°	2100lm	1700lm	ROS2-9405021D-WB											

Code Remark: D=D(DALI Dim)

Optional accessory

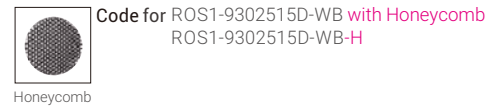

Track System

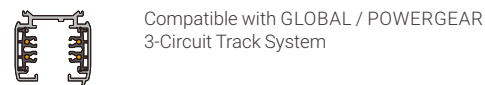

Coding

Model	CRI/ CCT	Beam Angle	Power	Control	Finish	Reflector Color	Accessory
ROS1	927	15	15	D	W	B	H
ROXY S-15W	CRI90/ 2700K	15°	15W	DALI Dim	White	Black	Honeycomb
ROS2	930	30	21		B		
ROXY S-21W	CRI90/3000K	30°	21W		Black		
	940	50					
	CRI90/ 4000K	50°					

ROXY K – In-track Driver LED Tracklight

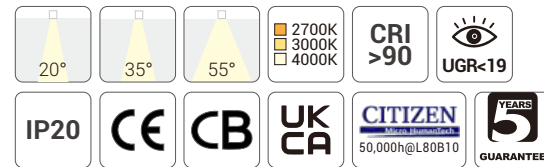

Quick Info

- CITIZEN LED: 28W, CRI>90
- CCT: 2700K, 3000K, 4000K Available as Standard
- Beam Angle: 20°, 35°, 55°
- Lumen Output: Up to 2600lm System Luminous Flux
- IP Class: IP20
- LED Driver: On-Off

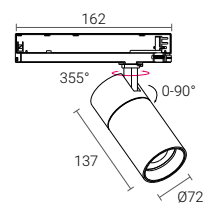

Light Distribution

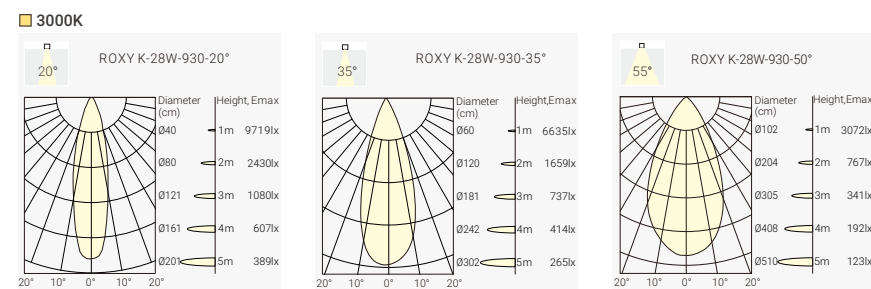

Finish



Order Info (ROXY K in White Housing & Black Reflector as an Example)

LED Power	System Power	LED Voltage	LED Current	CRI	CCT	Beam	LED Output	System Output	Code	
25W	28W	36V	700mA	90	2700K	20°	2500lm	2000lm	ROK1-9272028F-WB	
						35°	2500lm	2200lm	ROK1-9273528F-WB	
						55°	2500lm	2200lm	ROK1-9275528F-WB	
						3000K	15°	2700lm	2200lm	ROK1-9302028F-WB
							35°	2700lm	2400lm	ROK1-9303528F-WB
							55°	2700lm	2400lm	ROK1-9305528F-WB
						4000K	20°	2900lm	2400lm	ROK1-9402028F-WB
							35°	2900lm	2600lm	ROK1-9403528F-WB
							55°	2900lm	2600lm	ROK1-9405528F-WB

Code Remark: F=F(ON-OFF)

Coding

ROK1 - *** ** * - * * - *

Model	CRI/ CCT	Beam Angle	Power	Control	Finish	Reflector Color	Accessory
ROK1 ROXY K	927 CRI90/ 2700K	20°	28 28W	F On-Off	W White	B Black	H Honeycomb
	930 CRI90/3000K	35°			B Black		
	940 CRI90/ 4000K	55°					

Track System



Compatible with GLOBAL / POWERGEAR 3-Circuit Track System

ROXY K – In-track Driver LED Tracklight



Quick Info

- CITIZEN LED: 28W, CRI>90
- CCT: 2700K, 3000K, 4000K Available as Standard
- Beam Angle: 20°, 35°, 55°
- Lumen Output: Up to 2600lm System Luminous Flux
- IP Class: IP20
- LED Driver: DALL Dim

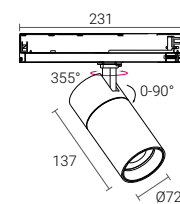

Light Distribution

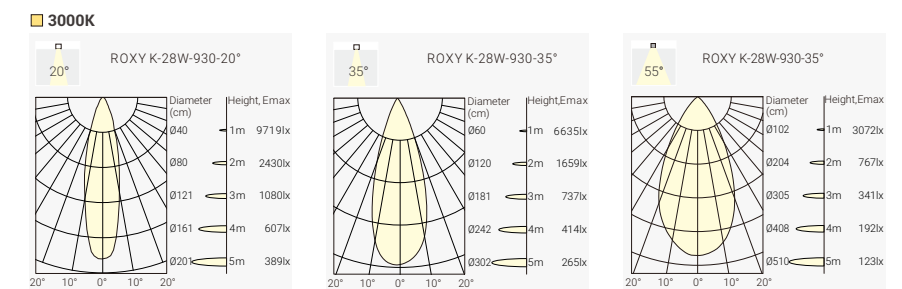

Finish



Order Info (ROXY K in White Housing & Black Reflector as an Example)

LED Power	System Power	LED Voltage	LED Current	CRI	CCT	Beam	LED Output	System Output	Code	
25W	28W	36V	700mA	90	2700K	20°	2500lm	2000lm	ROK1-9272028D-WB	
						35°	2500lm	2200lm	ROK1-9273528D-WB	
						55°	2500lm	2200lm	ROK1-9275528D-WB	
						3000K	15°	2700lm	2200lm	ROK1-9302028D-WB
							35°	2700lm	2400lm	ROK1-9303528D-WB
							55°	2700lm	2400lm	ROK1-9305528D-WB
						4000K	20°	2900lm	2400lm	ROK1-9402028D-WB
							35°	2900lm	2600lm	ROK1-9403528D-WB
							55°	2900lm	2600lm	ROK1-9405528D-WB

Code Remark: F=F(ON-OFF)

Coding

ROK1 - *** ** * - * * - *

Model	CRI/ CCT	Beam Angle	Power	Control	Finish	Reflector Color	Accessory
ROK1 ROXY K	927 CRI90/ 2700K	20°	28 28W	D DALI Dim	W White	B Black	H Honeycomb
	930 CRI90/3000K	35°			B Black		
	940 CRI90/ 4000K	55°					

Track System



Compatible with GLOBAL / POWERGEAR 3-Circuit Track System

ROXY – In-track Driver LED Tracklight

Beam Angle Zooming Version



ZOOM

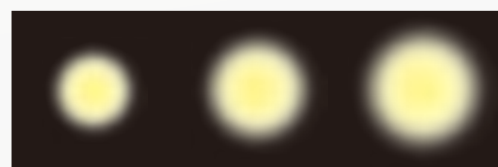
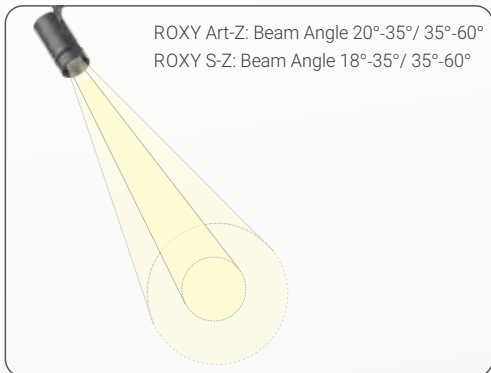
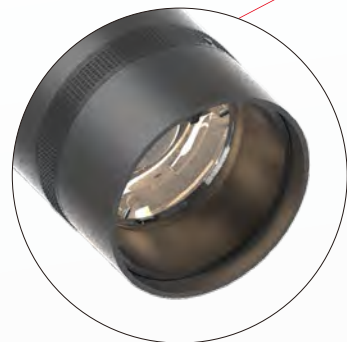

18°-60° Zooming

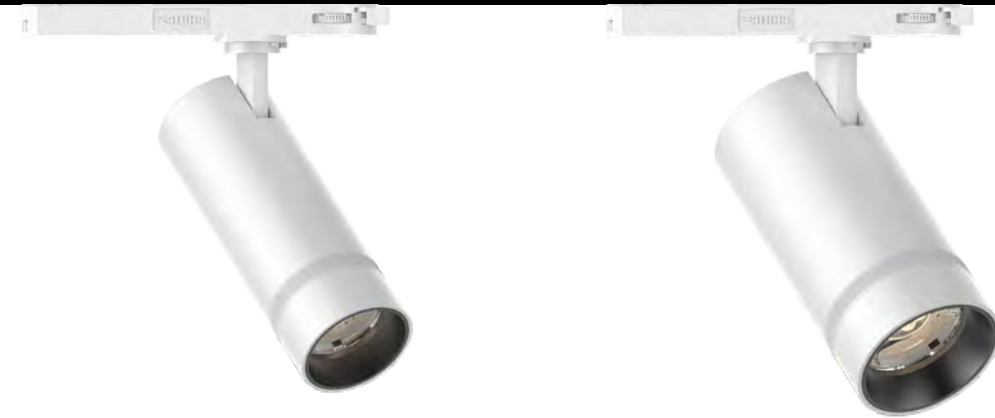

ROXY Art-Z

15W 1000lm-1200lm
20°-35° Zooming
35°-60° Zooming

ROXY S-Z

15W 1200lm-1400lm
21W 1600lm-1800lm
18°-35° Zooming
35°-60° Zooming

ROXY Art-Z – In-track Driver LED Tracklight



Quick Info

- CITIZEN LED: 15W, CRI>90
- CCT: 2700K, 3000K, 4000K Available as Standard
- Beam Angle: 20°~35°, 35°~60°
- Lumen Output: Up to 1200lm System Luminous Flux
- IP Class: IP20
- LED Driver: On-Off, DALL Dim

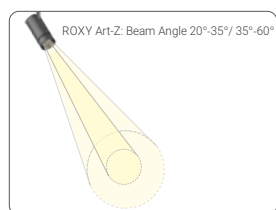
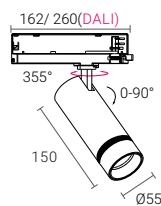

20°-60° Zooming

Finish



Optional accessory



Code for ROA1-930Z315F-WB with Honeycomb
ROA1-930Z315F-WB-H

Track System



Compatible with GLOBAL / POWERGEAR 3-Circuit Track System

ROXY S-Z – In-track Driver LED Tracklight



Quick Info

- CITIZEN LED: 15W, 21W, CRI>90
- CCT: 2700K, 3000K, 4000K Available as Standard
- Beam Angle: 18°~35°, 35°~60°
- Lumen Output: Up to 1800lm System Luminous Flux
- IP Class: IP20
- LED Driver: On-Off, DALL Dim

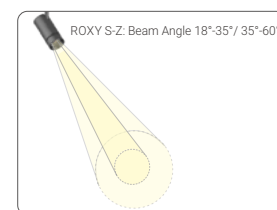
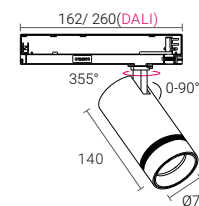

20°-60° Zooming

Finish



Optional accessory



Code for ROS1-930Z315F-WB with Honeycomb
ROS1-930Z315F-WB-H

Track System



Compatible with GLOBAL / POWERGEAR 3-Circuit Track System

Light Distribution

3000K

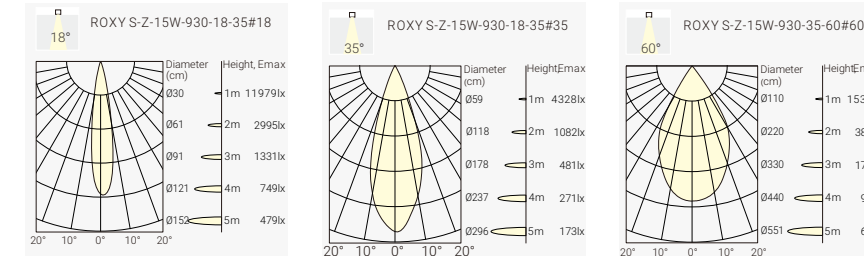

Order Info (ROXY S-Z in White Housing & Black Reflector as an Example)

LED Power	System Power	LED Voltage	LED Current	CRI	CCT	Beam	LED Output	System Output	Code
13W	15W	36V	350mA	90	2700K	18°~35°	1400lm	1200lm	ROS1-927Z315F-WB
					3000K	18°~35°	1500lm	1300lm	ROS1-930Z315F-WB
					4000K	18°~35°	1600lm	1400lm	ROS1-940Z315F-WB
					2700K	35°~60°	1400lm	1100lm	ROS1-927Z615F-WB
					3000K	35°~60°	1500lm	1200lm	ROS1-930Z615F-WB
					4000K	35°~60°	1600lm	1300lm	ROS1-940Z615F-WB
18W	21W	36V	500mA	90	2700K	18°~35°	1900lm	1600lm	ROS1-927Z321F-WB
					3000K	18°~35°	2000lm	1700lm	ROS1-930Z321F-WB
					4000K	18°~35°	2100lm	1800lm	ROS1-940Z321F-WB
					2700K	35°~60°	1900lm	1500lm	ROS1-927Z621F-WB
					3000K	35°~60°	2000lm	1600lm	ROS1-930Z621F-WB
					4000K	35°~60°	2100lm	1700lm	ROS1-940Z621F-WB

Code Remark: F=F(ON-OFF) D=D(DALI Dim)

Coding

Model	CRI/ CCT	Beam Angle	Power	Control	Finish	Reflector Color	Accessory
ROS1	927	Z3	15	F	W	B	H
ROXY S-Z	CRI90/ 2700K	20°~35°	15W	On-Off	White	Black	Honeycomb
	930	Z6	21	D	B		
	CRI90/3000K	35°~60°	21W	DALI Dim	Black		
	940						
	CRI90/ 4000K						

DASH Smart

The Modular Design
3-phase Linear Tracklight

Ecodesign for Sustainable Products
Replaceability of light sources and
separated control

- Linear Accent Light in Chrome-black or Specular reflector
- 80° beam angle and UGR<19
- Uniform illumination and visual comfort
- Linear General Light within micro-prismatic cover, to ensure maximum homogeneous lighting
- Lumen output adjustable via dip switch on LED driver (ON-OFF or DALI Dim)
- Lumen efficiency up to 140lm/W



Project: Office Project in Hunxe, Germany

NEW



3-phase Track System

Global
Stucchi
Powergear

Linear Accent Light

80° beam angle, UGR<19
Uniform illumination and visual comfort
Reflector in Chrome Black or Specular
Housing color in Black or White
Lumen efficiency up to 140lm/W

Linear General Light

Within micro-prismatic cover,
to ensure homogeneous lighting
Housing color in Black or White
Lumen efficiency up to 120lm/W

In-Track LED Driver and Lamp Holder

DASH Smart 50W in-Track LED Driver (ON-OFF or DALI Dim)

- Dimension: 672mm x 13.8mm (31mm) x 31.5mm
- Maximum Secondary Power: 50.4W
- Output Voltage Range: 24-48V; Maximum Output Voltage: 60V
- Input Voltage: 220-240V~50/60Hz; Overvoltage Resistance: 320V, 1h
- Inrush current: 20A, 280µs
- Automatic Circuit Breaker: 22pcs on B16A, 37pcs on C16A

- ① Adjustable Output Current between 350-1050mA via DIP Switch
- ② L1, L2 and L3 phase switchable
- ③ Lamp Holder within GR6d Retaining Element for 3-phase Power Rails with Locking Mechanism



! NEW

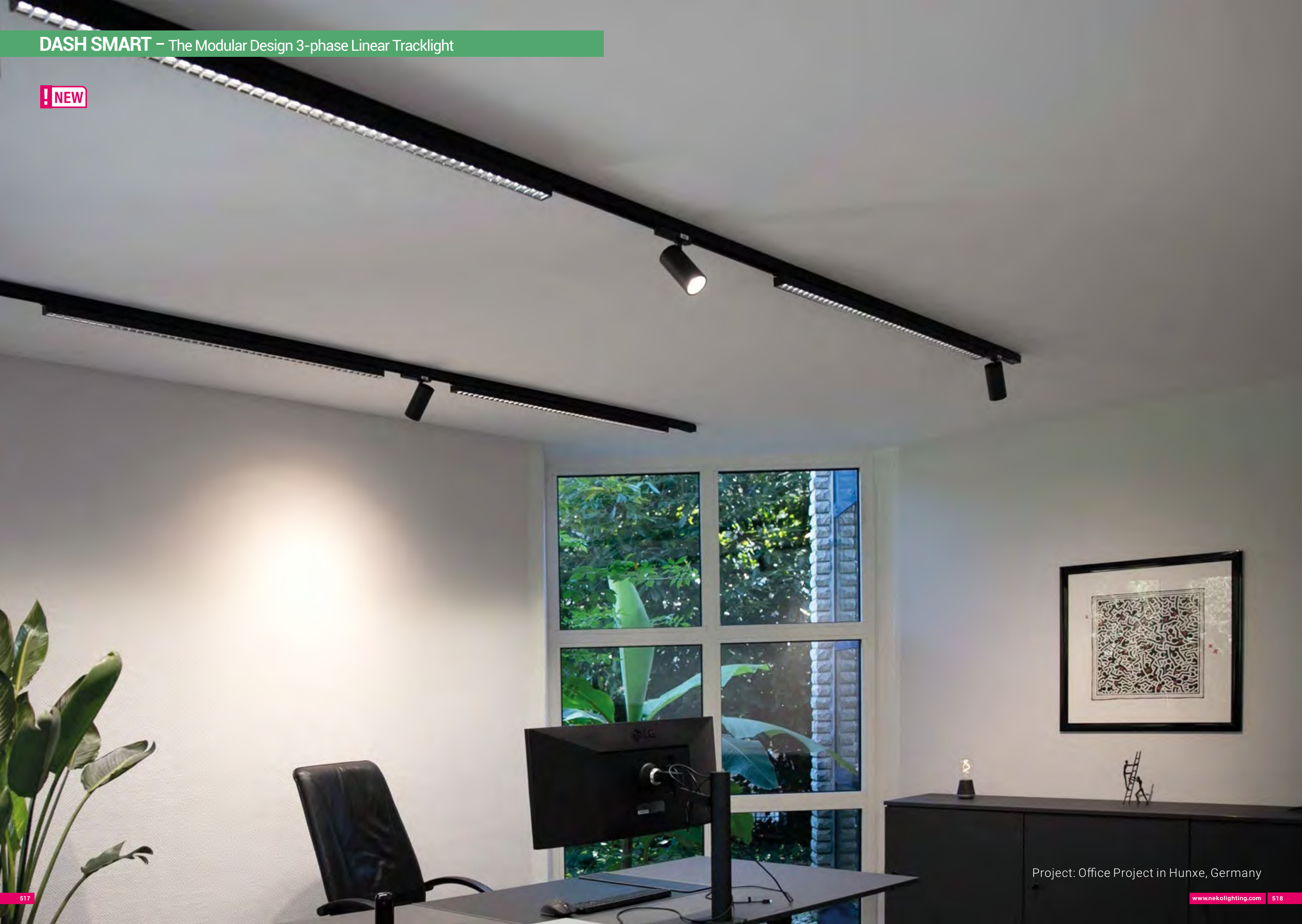

DASH SMART – The Modular Design 3-phase Linear Tracklight



Quick Info

- The Modular Design 3-phase Linear Tracklight
- Housing color in White or Black
- Reflector color in Chrome-black or Specular
- 80° beam angle and UGR<19
- Uniform illumination and visual comfort
- CCT: 3000K, 4000K Available as Standard
- Lumen output adjustable via dip switch on LED driver
- Lumen efficiency up to 140lm/W
- LED Driver: ON-OFF or DALI Dim

Light Distribution

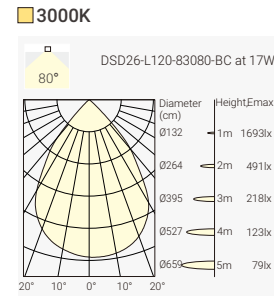

Color Options



Order Info (DSD26 in black housing & chrome-black reflector as an example)

Length	Code	LED Current	System Power	CRI	CCT	Beam	System Output
864mm	DSD26-L090-83080N-BC	@350 mA	17 W	80	3000K	80°	2350lm
					4000K	80°	2500lm
		@500 mA	24 W	80	3000K	80°	3300lm
1164mm	DSD26-L120-83080N-BC	@350 mA	17 W	80	3000K	80°	2350lm
					4000K	80°	2500lm
		@500 mA	24 W	80	3000K	80°	3300lm
1464mm	DSD26-L150-83080N-BC	@350 mA	17 W	80	3000K	80°	2350lm
					4000K	80°	2500lm
		@500 mA	24 W	80	3000K	80°	3300lm
		@700 mA	34 W	80	3000K	80°	4500lm
		@1050 mA	50 W	80	3000K	80°	7250lm
					4000K	80°	4900lm
					4000K	80°	3600lm
					4000K	80°	3600lm
					4000K	80°	4900lm

Code Remark: N=N(No Driver) F=F(ON-OFF) D=D(DALI Dim)

Coding

Model	CRI/ CCT	Beam Angle	Control	Housing Finish	Reflector Color
DSD26-L090 DSD26 864mm	830 CRI80/ 3000K	80 80°	N No Driver	W White	C Chrome Black
DSD26-L120 DSD26 1164mm	840 CRI80/ 4000K		F On-Off	B Black	S Specular
DSD26-L150 DSD26 1464mm			D DALI Dim		

DASH SMART – The Modular Design 3-phase Linear Tracklight



Quick Info

- The Modular Design 3-phase Linear Tracklight
- Housing color in White or Black
- General Light in Microprismatic Cover
- 90° beam angle, homogeneous lighting
- CCT: 3000K, 4000K Available as Standard
- Lumen output adjustable via dip switch on LED driver
- Lumen efficiency up to 120lm/W
- LED Driver: ON-OFF or DALI Dim

Light Distribution

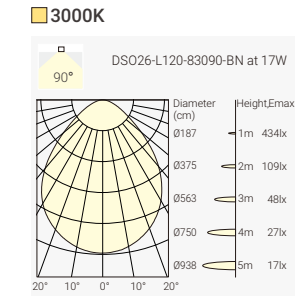
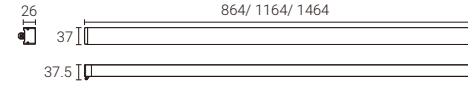

Color Options

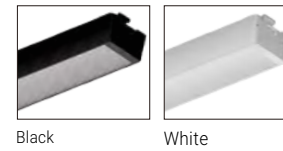

Order Info (DSO26 in black housing as an example)

Length	Code	LED Current	System Power	CRI	CCT	Beam	System Output
864mm	DSO26-L090-83090N-BN	@350 mA	17 W	80	3000K	90°	2000lm
					4000K	90°	2200lm
		@500 mA	24 W	80	3000K	90°	2750lm
1164mm	DSO26-L120-83090N-BN	@350 mA	17 W	80	3000K	90°	2000lm
					4000K	90°	2200lm
		@500 mA	24 W	80	3000K	90°	2750lm
1464mm	DSO26-L150-83090N-BN	@350 mA	17 W	80	3000K	90°	2000lm
					4000K	90°	2200lm
		@500 mA	24 W	80	3000K	90°	2750lm
		@700 mA	34 W	80	3000K	90°	3600lm
		@1050 mA	50 W	80	3000K	90°	5000lm
					4000K	90°	3900lm
					4000K	90°	3000lm
					4000K	90°	3900lm

Code Remark: N=N(No Driver) F=F(ON-OFF) D=D(DALI Dim)

Coding

Model	CRI/ CCT	Beam Angle	Control	Trim Finish	Reflector Color
DSO26-L090 DSO26 864mm	830 CRI80/ 3000K	90 90°	N No Driver	W White	N None
DSO26-L120 DSO26 1164mm	840 CRI80/ 4000K		F On-Off	B Black	
DSO26-L150 DSO26 1464mm			D DALI Dim		

INLINE

Single Phase LED Tracklight System
Incl. Phase Dim Driver
Direct Connection 230V – No External Driver



INLINE – Single Phase LED Tracklight System

Incl. Phase Dim Driver
Direct Connection 230V – No External Driver



INLINE ST-11W
11W, 36°, 700lm at CRI>90 2700K



INLINE SP-8W
8W, 36°, 500lm at CRI>90 2700K

INLINE – Single Phase LED Tracklight System



Quick Info

- LUMINUS LED: 9W, CRI>90
- CCT: 2700K Available as Standard
- Beam Angle: 36°
- Lumen Output: Up to 700lm System Luminous Flux
- IP Class: IP20
- LED Driver: Phase Dim

Light Distribution

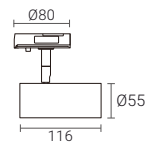
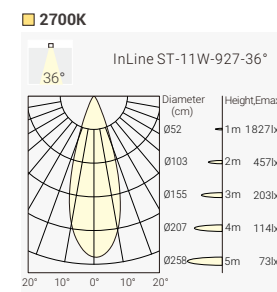

Finish



Order Info

LED Power	System Power	LED Voltage	LED Current	CRI	CCT	Beam	LED Output	System Output	Code
9W	11W	18V	500mA	90	3000K	36°	900lm	700lm	ILST-9273611P-WB
9W	11W	18V	500mA	90	3000K	36°	900lm	700lm	ILST-9273611P-BB

Code Remark: P=P(Phase Dim)

Track System

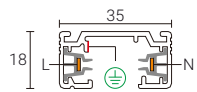

Compatible with NEKO INLINE Single Circuit Track System

INLINE – Single Phase LED Tracklight System



Quick Info

- LUMINUS LED: 6W, CRI>90
- CCT: 2700K Available as Standard
- Beam Angle: 36°
- Lumen Output: Up to 500lm System Luminous Flux
- IP Class: IP20
- LED Driver: Phase Dim

Light Distribution

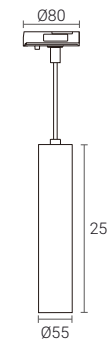
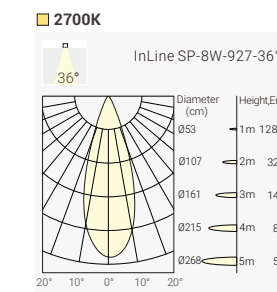

Finish



Order Info

LED Power	System Power	LED Voltage	LED Current	CRI	CCT	Beam	LED Output	System Output	Code
9W	8W	18V	350mA	90	2000K	36°	700lm	500lm	ILSP-9273608P-WB
9W	8W	18V	350mA	90	2000K	36°	700lm	500lm	ILSP-9273608P-BB

Code Remark: P=P(Phase Dim)

Track System

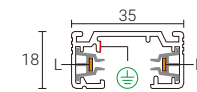

Compatible with NEKO INLINE Single Circuit Track System

INLINE – Single Phase LED Tracklight System



Quick Info

- Aluminum extrusion track shell
- 2 pieces copper busbars, insulated by plastic
- Single circuit track system for 16A (3500W) input
- Track length available in 1000mm and 2000mm
- Various connectors and accessories available for building comprehensive lighting system
- Color finish in White(RAL9003) or Black(RAL9005)
- Surface mounted

Load of Track

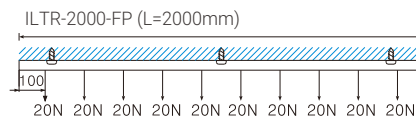
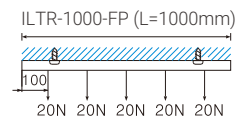
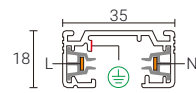

Connection Diagram

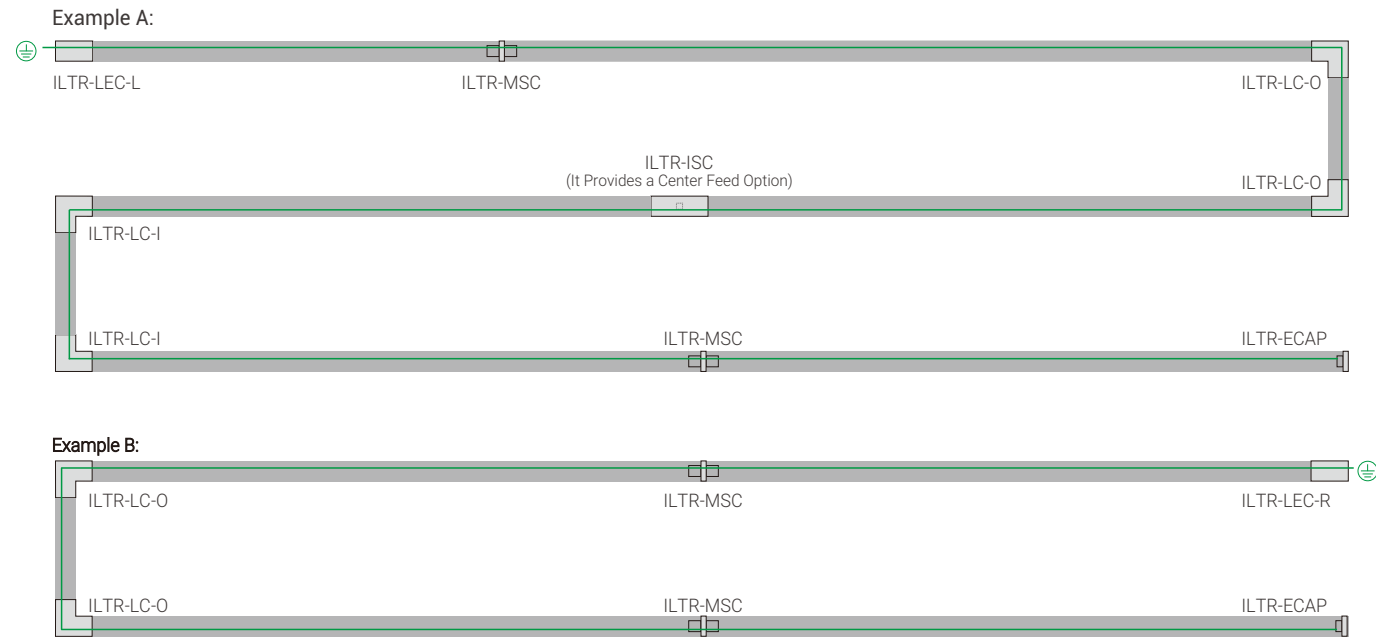

INLINE Single Phase Track

Description

- _____
INLINE Single Phase Track, 1000mm Length, White
- _____
INLINE Single Phase Track, 1000mm Length, Black
- _____
INLINE Single Phase Track, 2000mm Length, White
- _____
INLINE Single Phase Track, 2000mm Length, Black

Code/Model

- _____
ILTR-1000-FP-W
- _____
ILTR-1000-FP-B
- _____
ILTR-2000-FP-W
- _____
ILTR-2000-FP-B

Live End Connector

Description

- _____
Live End Connector, Left, White
- _____
Live End Connector, Left, Black
- _____
Live End Connector, Right, White
- _____
Live End Connector, Right, Black

Code/Model

- _____
ILTR-LEC-L-W
- _____
ILTR-LEC-L-B
- _____
ILTR-LEC-R-W
- _____
ILTR-LEC-R-B

I Straight Connector

Description

- _____
I Straight Connector, It Provides a Center Feed Option, White
- _____
I Straight Connector, It Provides a Center Feed Option, Black

Code/Model

- _____
ILTR-ISC-W
- _____
ILTR-ISC-B

L Connector

Description

- _____
L Connector, Outer, White
- _____
L Connector, Outer, Black
- _____
L Connector, Inner, White
- _____
L Connector, Inner, Black

Code/Model

- _____
ILTR-LC-O-W
- _____
ILTR-LC-O-B
- _____
ILTR-LC-I-W
- _____
ILTR-LC-I-B

Mini Straight Connector

Description

- _____
Mini Straight Connector, White
- _____
Mini Straight Connector, Black

Code/Model

- _____
ILTR-MSC-W
- _____
ILTR-MSC-B

Endcap

Description

- _____
Endcap, White
- _____
Endcap, Black

Code/Model

- _____
ILTR-ECAP-W
- _____
ILTR-ECAP-B

LED Strip Light

- SL2835A, Standard LED Strip Light
- SL2835B, High Efficiency LED Strip Light
- SL5050C, RGBW LED Strip Light
- SL2835D, FCOB LED Strip Light

Modeling:

SL 2835 A - 24 - 120 - 12W - 65

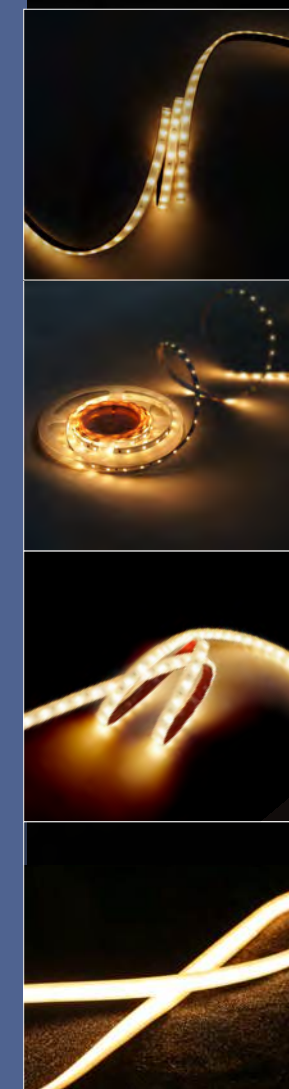
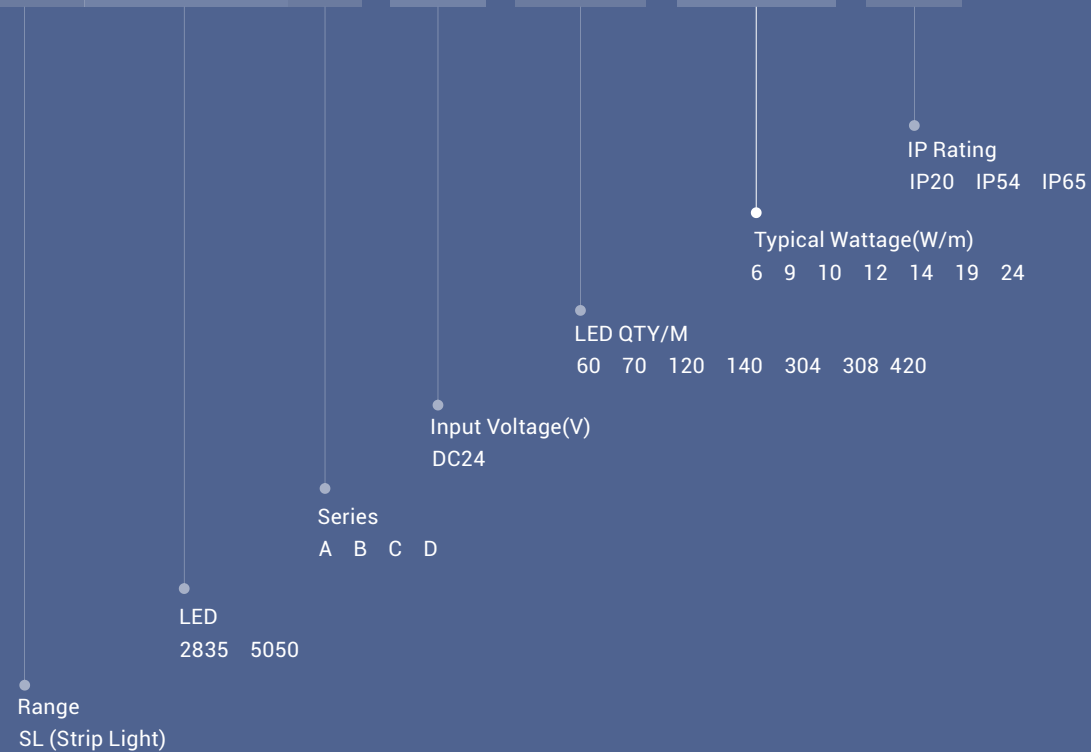

SL2835A, Standard LED Strip Light

SL2835B, High Efficiency LED Strip Light

SL5050C, RGBW LED Strip Light

SL2835D, FCOB LED Strip Light

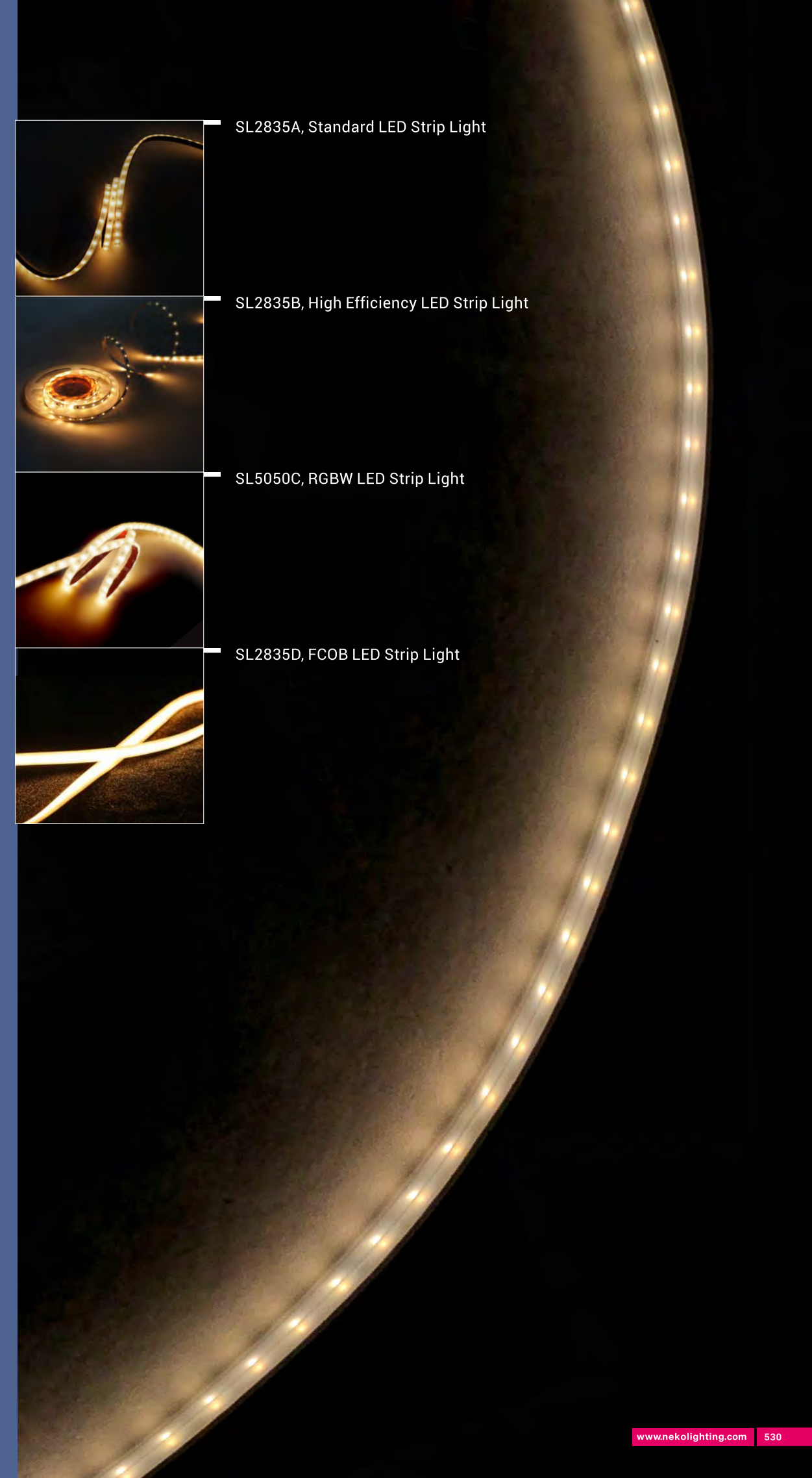

LED Strip Light



Primary Model	Model No.	Input Voltage (V)	LED QTY/M	Typical Wattage (W/M)	IP Rating	CCT	Ra	Width (mm)	Length (M)	Min.cutting unit	Min.cutting length (mm)	lm/M @4000K	lm/W	Warranty (yrs)
SL2835A, Standard LED Strip Light														
	SL2835A-24-060-6W-20	DC24	60	6	IP20/IP65	2200K 2700K 3000K 3500K 4000K 5000K	>90	8	5	6 LEDS	100	600	100	3 yrs
	SL2835A-24-060-9W-20	DC24	60	9	IP20/IP65	2200K 2700K 3000K 3500K 4000K 5000K	>90	8	5	6 LEDS	100	900	100	3 yrs
SL2835A	SL2835A-24-120-6W-20	DC24	120	6	IP20/IP65	2200K 2700K 3000K 3500K 4000K 5000K	>90	8	5	6 LEDS	50	600	100	3 yrs
	SL2835A-24-120-9W-20	DC24	120	9	IP20/IP65	2200K 2700K 3000K 3500K 4000K 5000K	>90	8	5	6 LEDS	50	900	100	3 yrs
	SL2835A-24-120-12W-20	DC24	120	12	IP20/IP65	2200K 2700K 3000K 3500K 4000K 5000K	>90	8	5	6 LEDS	50	1200	100	3 yrs

Primary Model	Model No.	Input Voltage (V)	LED QTY/M	Typical Wattage (W/M)	IP Rating	CCT	Ra	Width (mm)	Length (M)	Min.cutting unit	Min.cutting length (mm)	lm/M @4000K	lm/W	Warranty (yrs)
SL2835B, High Efficiency LED Strip Light														
	SL2835B-24-070-6W-20	DC24	70	6	IP20/IP65	2200K 2700K 3000K 3500K 4000K 5000K	>90	10	5	7 LEDS	100	660	110	3 yrs
	SL2835B-24-070-9W-20	DC24	70	9	IP20/IP65	2200K 2700K 3000K 3500K 4000K 5000K	>90	10	5	7 LEDS	100	990	110	3 yrs
SL2835B	SL2835B-24-140-6W-20	DC24	140	6	IP20/IP65	2200K 2700K 3000K 3500K 4000K 5000K	>90	10	5	7 LEDS	50	660	110	3 yrs
	SL2835B-24-140-9W-20	DC24	140	9	IP20/IP65	2200K 2700K 3000K 3500K 4000K 5000K	>90	10	5	7 LEDS	50	990	110	3 yrs
	SL2835B-24-140-12W-20	DC24	140	12	IP20/IP65	2200K 2700K 3000K 3500K 4000K 5000K	>90	10	5	7 LEDS	50	1320	110	3 yrs

Primary Model	Model No.	Input Voltage (V)	LED QTY/M	Typical Wattage (W/M)	IP Rating	CCT	Ra	Width (mm)	Length (M)	Min.cutting unit	Min.cutting length (mm)	lm/M @4000K	lm/W	Warranty (yrs)
SL5050C, RGBW LED Strip Light														
SL5050C	SL5050C-24-060-12W-20	DC24	60	12	IP20/IP65	R G B W	>80	10	5	6 LEDS	100	270lm for White	90	3 yrs

Primary Model	Model No.	Input Voltage (V)	LED QTY/M	Typical Wattage (W/M)	IP Rating	CCT	Ra	Width (mm)	Length (M)	Min.cutting unit	Min.cutting length (mm)	lm/M @4000K	lm/W	Warranty (yrs)
SL2835D, FC0B LED Strip Light														
	SL2835D-24-308-10W-54	DC24	308	10	IP54	2700K 3000K 3500K 4000K 5000K	>90	10	5	7 LEDS	22.7	1330	95	3 yrs
	SL2835D-24-308-14W-54	DC24	308	14	IP54	2700K 3000K 3500K 4000K 5000K	>90	10	5	7 LEDS	22.7	2280	95	3 yrs
	SL2835D-24-304-14W-54	DC24	304	14	IP54	2700K 3000K 3500K 4000K 5000K	>90	10	5	8 LEDS	26.3	2280	118	3 yrs
SL2835D	SL2835D-24-304-19W-54	DC24	304	19	IP54	2700K 3000K 3500K 4000K 5000K	>90	10	5	8 LEDS	26.3	2280	118	3 yrs
	SL2835D-24-304-24W-54	DC24	304	24	IP54	2700K 3000K 3500K 4000K 5000K	>90	10	5	8 LEDS	26.3	2830	118	3 yrs

! NEW



SL2835A

- Standard version flexible LED strip light;
- Available in 2200K/ 2700K/ 3000K/ 3500K/ 4000K/ 5000K
- Color rendering index (CRI): Ra>90
- Easy installation featuring 3M VHB adhesive backing
- Top lighting and top bending
- L70B50@50,000 hours

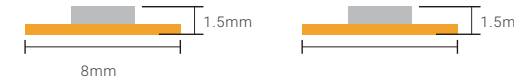

Technical Specification (IP20 Version)					
Model No.	SL2835A-24-060-6W-20	SL2835A-24-060-9W-20	SL2835A-24-120-6W-20	SL2835A-24-120-9W-20	SL2835A-24-120-12W-20
Input Voltage(V)	DC24	DC24	DC24	DC24	DC24
LED QTY	60/M	60/M	120/M	120/M	120/M
Typical Wattage	6W/M	9W/M	6W/M	9W/M	12W/M
IP Rating	IP20	IP20	IP20	IP20	IP20
CRI	Ra>90	Ra>90	Ra>90	Ra>90	Ra>90
CCT	2200K/2700K/3000K/3500K/4000K/5000K				
Width	8mm	8mm	8mm	8mm	8mm
Length	5M	5M	5M	5M	5M
Min. cutting Unit	6 LEDS	6 LEDS	6 LEDS	6 LEDS	6 LEDS
Min. cutting length	100mm	100mm	50mm	50mm	50mm
Lm/M @4000K	600	900	600	900	1200
Lm/W	100	100	100	100	100
ERP	A+	A+	A+	A+	A+
Warranty	3 yrs	3 yrs	3 yrs	3 yrs	3 yrs
Technical Specification (IP65 Version)					
Model No.	SL2835A-24-060-6W-65	SL2835A-24-060-9W-65	SL2835A-24-120-6W-65	SL2835A-24-120-9W-65	SL2835A-24-120-12W-65
Input Voltage(V)	DC24	DC24	DC24	DC24	DC24
LED QTY/M	60/M	60/M	120/M	120/M	120/M
Typical Wattage	6W/M	9W/M	6W/M	9W/M	12W/M
IP Rating	IP65	IP65	IP65	IP65	IP65
CRI	Ra>90	Ra>90	Ra>90	Ra>90	Ra>90
CCT	2200K/2700K/3000K/3500K/4000K/5000K				
Width	10mm	10mm	10mm	10mm	10mm
Length	5M	5M	5M	5M	5M
Min. cutting Unit	6 LEDS	6 LEDS	6 LEDS	6 LEDS	6 LEDS
Min. cutting length	100mm	100mm	50mm	50mm	50mm
Lm/M @4000K	540	810	540	810	1080
Lm/W	90	90	90	90	90
ERP	A+	A+	A+	A+	A+
Warranty	3 yrs	3 yrs	3 yrs	3 yrs	3 yrs

Recommended Accessories

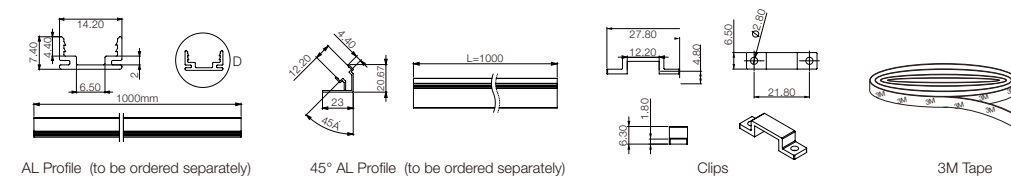

Ordering Code

SL2835A - 24 - 060 - 6W - 20 - 2000K - *

Model	Input Voltage(V)	LED QTY/M	Typical Wattage/ M	IP Rating	CCT	Accessories
SL2835A	24 DC24V	060	6W	20	2200K	3M Tape
		60pcs	9W	IP20	2700K	Clips
		120	12W	65	3000K	AL Profile
		120pcs		IP65	3500K	45° AL Profile
					4000K	
					5000K	

! NEW

SL2835B

- High efficiency LED strip light
- Available in 2200K/ 2700K/ 3000K/ 3500K/ 4000K/ 5000K
- Color rendering index (CRI): Ra>90
- Semi-transparent silicone extrusion for IP65 with salt-mist proof
- Top lighting and top bending
- L70B50@50,000 hours

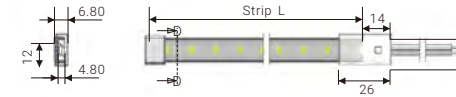

Technical Specification (IP20 Version)					
Model No.	SL2835B-24-070-6W-20	SL2835B-24-070-9W-20	SL2835B-24-140-6W-20	SL2835B-24-140-9W-20	SL2835B-24-140-12W-20
Input Voltage(V)	DC24	DC24	DC36	DC24	DC24
LED QTY	70/M	70/M	140/M	140/M	140/M
Typical Wattage	6W/M	9W/M	6W/M	9W/M	12W/M
IP Rating	IP20	IP20	IP20	IP20	IP20
CRI	Ra>90	Ra>90	Ra>90	Ra>90	Ra>90
CCT	2200K/2700K/3000K/3500K/4000K/5000K				
Width	10mm	10mm	10mm	10mm	10mm
Length	5M	5M	5M	5M	5M
Min. cutting Unit	7 LEDS	7 LEDS	7 LEDS	7 LEDS	7 LEDS
Min. cutting length	100mm	100mm	50mm	50mm	50mm
Lm/M @4000K	660	990	660	990	1320
Lm/W	110	110	110	110	110
ERP	A+	A+	A+	A+	A+
Warranty	3 yrs	3 yrs	3 yrs	3 yrs	3 yrs
Technical Specification (IP65 Version)					
Model No.	SL2835B-24-070-6W-65	SL2835B-24-070-9W-65	SL2835B-24-140-6W-65	SL2835B-24-140-9W-65	SL2835B-24-140-12W-65
Input Voltage(V)	Dc24	DC24	DC24	DC24	DC24
LED QTY/M	70/M	70/M	140/M	140/M	140/M
Typical Wattage	6W/M	9W/M	6W/M	9W/M	12W/M
IP Rating	IP65	IP65	IP65	IP65	IP65
CRI	Ra>90	Ra>90	Ra>90	Ra>90	Ra>90
CCT	2200K/2700K/3000K/3500K/4000K/5000K				
Width	12mm	12mm	12mm	12mm	12mm
Length	5M	5M	5M	5M	5M
Min. cutting Unit	7 LEDS	7 LEDS	7 LEDS	7 LEDS	7 LEDS
Min. cutting length	100mm	100mm	50mm	50mm	50mm
Lm/M @4000K	600	900	600	600	1200
Lm/W	100	100	100	100	100
ERP	A+	A+	A+	A+	A+
Warranty	3 yrs	3 yrs	3 yrs	3 yrs	3 yrs

Recommended Accessories

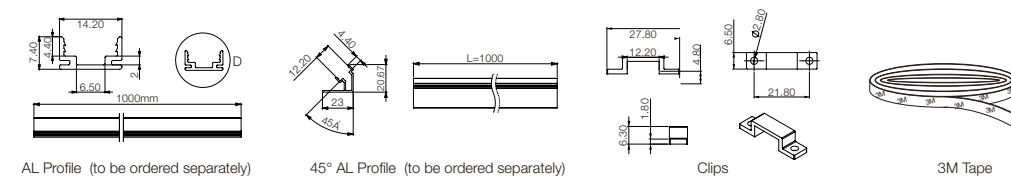

Ordering Code

SL2835B - 24 - 060 - 6W - 20 - 2000K - *

Model	Input Voltage(V)	LED QTY/M	Typical Wattage/ M	IP Rating	CCT	Accessories
SL2835B	24 DC24V	070	6W	20	2200K	3M Tape
		70pcs	9W	IP20	2700K	Clips
		140			3000K	AL Profile
		140pcs	12W	IP65	3500K	45° AL Profile
					4000K	
				5000K		

! NEW

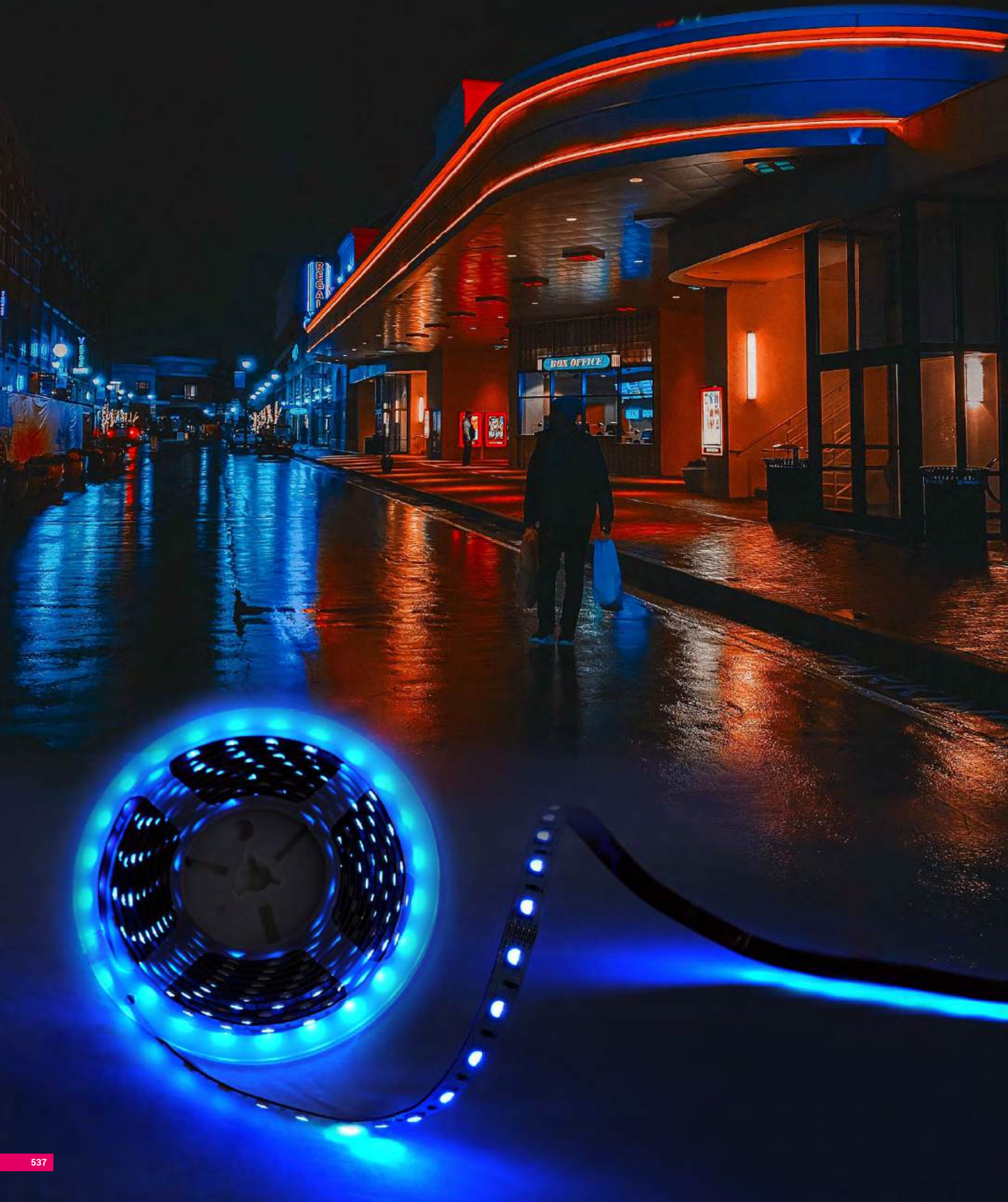

SL5050C

- RGBW colorful flexible LED strip light;
- Widely adaptable to all types of dimming and toning controller
- Color rendering index (CRI): Ra>90
- High quality FPC, high thermal 3M adhesive
- Top lighting and top bending•
- L70B50@50,000 hours;

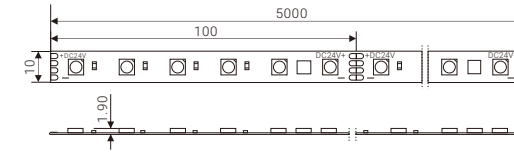

Technical Specification		
Version	IP20 Version	IP65 Version
Model No.	SL5050C-24-060-12W-20	SL5050C-24-060-12W-65
Input Voltage(V)	DC24	DC24
LED QTY	60/M	60/M
Typical Wattage	12W/M	12W/M
IP Rating	IP20	IP65
CRI	Ra>80	Ra>80
CCT	RGBW	
Width	10mm	12mm
Length	5M	5M
Min. cutting Unit	6 LEDS	6 LEDS
Min. cutting length	100mm	100mm
Lm/M @4000K	270lm for White	270lm for White
Lm/W	100	90
ERP	A+	A+
Warranty	3 yrs	3 yrs

Recommended Accessories

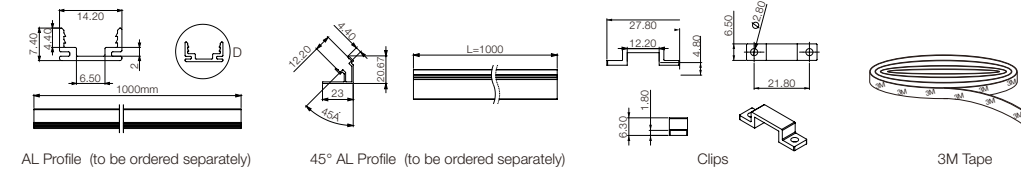

Ordering Code

Model	Input Voltage(V)	LED QTY/M	Typical Wattage/ M	IP Rating	CCT	Accessories
SL2835B	24 DC24V	060 60pcs	6W	20 IP20 65 IP65	R G B W	3M Tape Clips AL Profile 45° AL Profile

! NEW



SL2835D

- Ultra-thin design with super flexible bending performance
- Seamless COB design that eliminates virtually all LED dotting
- Available in 2200K/ 2700K/ 3000K/ 3500K/ 4000K/ 5000K
- Color rendering index (CRI): Ra>90
- Easy installation featuring 3M VHB adhesive backing
- Available in silicone glue IP54 rating for indoor outdoor locations
- L70B50@50,000 hours

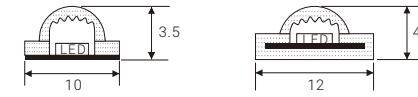
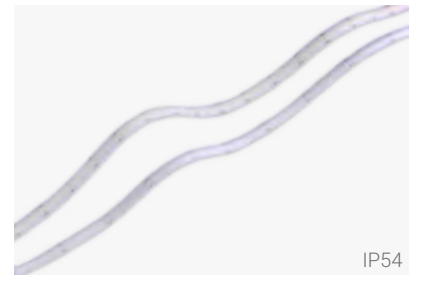

Technical Specification (IP54 Version)				
Model No.	SL2835D-24-308-10W-54	SL2835D-24-308-14W-54	SL2835D-24-304-14W-54	SL2835D-24-304-19W-54
Input Voltage(V)	DC24	DC24	DC36	DC24
LED QTY	308/M	308/M	304/M	304/M
Typical Wattage	10W/M	14W/M	14W/M	19W/M
IP Rating	IP54	IP54	IP54	IP54
CRI	Ra>90	Ra>90	Ra>90	Ra>90
CCT	2700K/3000K/3500K/4000K/5000K			
Width	10mm	10mm	10mm	10mm
Length	5M	5M	5M	5M
Min. cutting Unit	7 LEDS	7 LEDS	8 LEDS	8 LEDS
Min. cutting length	22.7mm	22.7mm	26.3mm	26.3mm
Lm/M @4000K	1330	1330	2280	2280
Lm/W	95	95	118	118
ERP	A+	A+	A+	A+
Warranty	3 yrs	3 yrs	3 yrs	3 yrs

Technical Specification (IP54 Version)			
Model No.	SL2835D-24-304-24W-54	SL2835D-24-420-14W-54	SL2835D-24-420-19W-54
Input Voltage(V)	DC24	DC24	DC24
LED QTY	304/M	420/M	420/M
Typical Wattage	24W/M	14W/M	19W/M
IP Rating	IP65	IP65	IP65
CRI	Ra>90	Ra>90	Ra>90
CCT	2700K/3000K/3500K/4000K/5000K		
Width	10mm	10mm	10mm
Length	5M	5M	5M
Min. cutting length	8 LEDS	14 LEDS	14 LEDS
Min. cutting length	26.3mm	33.3mm	33.3mm
Lm/M @4000K	2280	1650	1650
Lm/W	118	86	86
ERP	A+	A+	A+
Warranty	3 yrs	3 yrs	3 yrs

Recommended Accessories

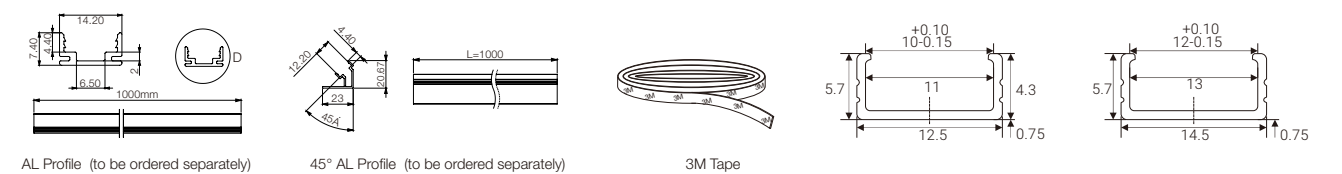

Ordering Code

SL2835D - 24 - 304 - 10W - 54 - 2700K - *

Model	Input Voltage(V)	LED QTY/M	Typical Wattage/ M	IP Rating	CCT	Accessories
SL2835D	24 DC24V	304 304pcs 308 308pcs 420 420pcs	10W 19W 24W	54 IP54	2700K 3000K 3500K 4000K 5000K	3M Tape AL Profile 45° AL Profile

LED Neon Flex

NF1717T, 16.5*16.5mm Top Bending Neon Flex

NF0817S, 8*16.5mm Side Bending Neon Flex

NF1221S, 11.5*21mm Side Bending Neon Flex

NF1228S, 11.5*28mm Side Bending Neon Flex

Modeling:

NF 1717 T -24 -120 - 9W -68

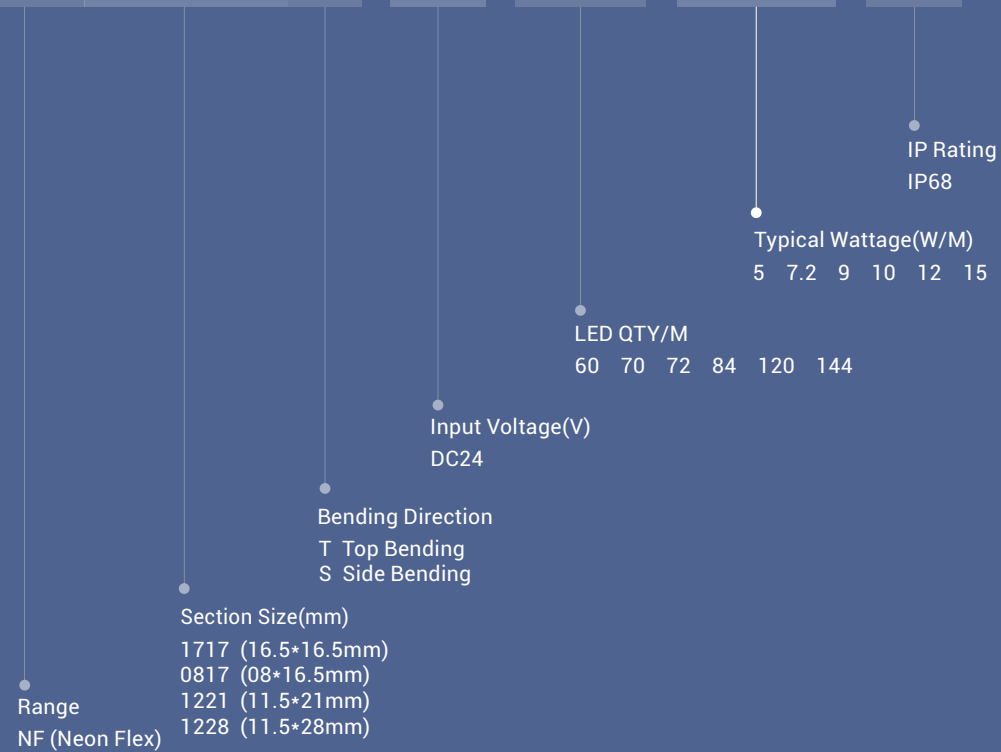

NF1717T Top Bending (IP68)



NF0817S Side Bending (IP68)



NF1221S Side Bending (IP68)



NF1228S Side Bending (IP68)

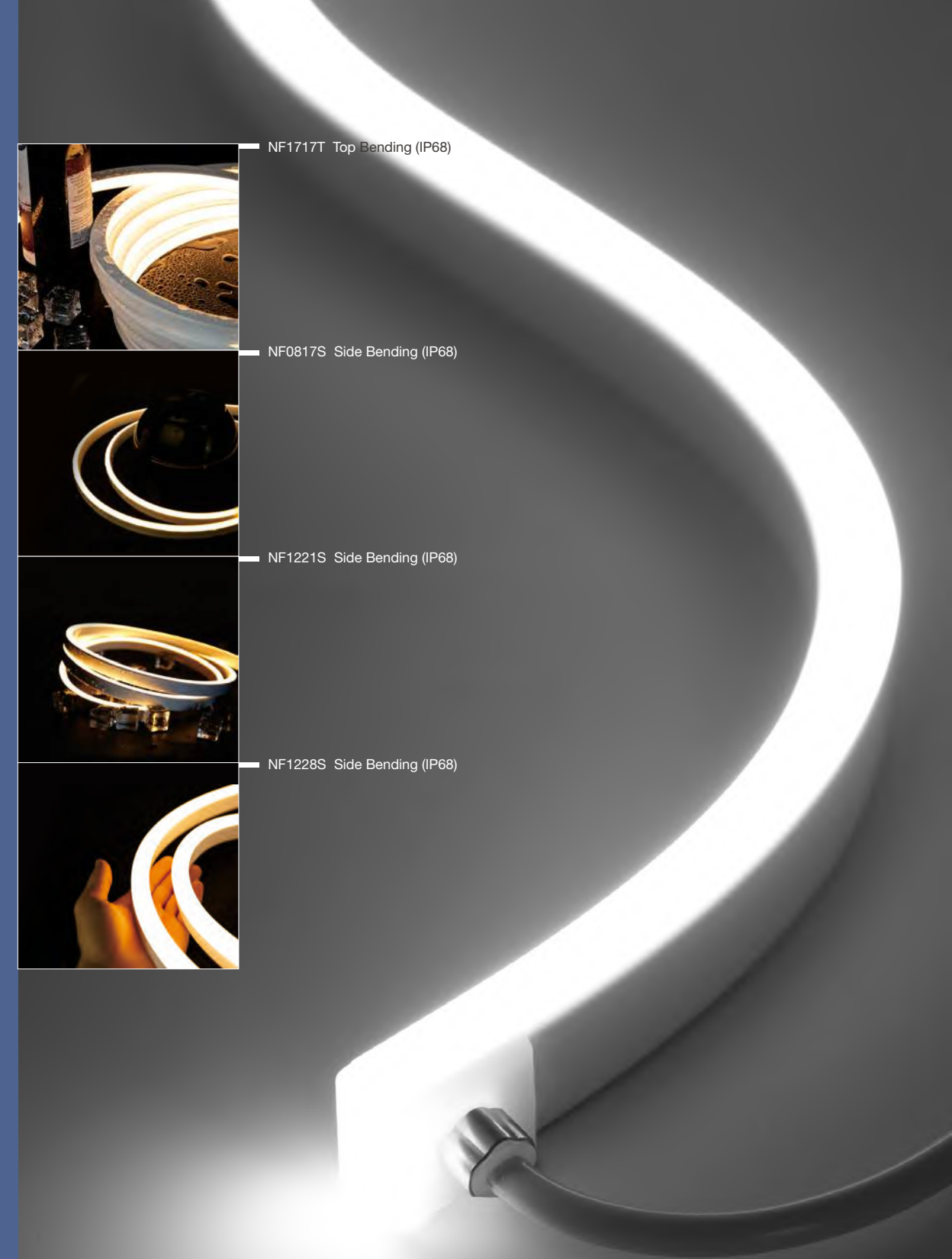



Primary Model	Model No.	Input Voltage (V)	LED QTY/M	Typical Wattage (W/M)	CCT	Section Size(mm)	Ra	Max.Length single feed(M)	Max.Length double feed(M)	Min.cutting unit	Min.cutting length (mm)	lm/M @4000K	lm/W	Warranty (yrs)
Top Bending (IP68)														
NF1717T	NF1717T-24-120-9W	DC24	120	9	2200K 2700K 3000K 3500K 4000K 5000K R G B P A O LY	16.5*16.5	>90	10	20	12 LEDS	100	>340	37	3 yrs
	NF1717T-24-144-10W	DC24	144	10	2200K 2700K 3000K 3500K 4000K 5000K R G B P A O	16.5*16.5	>90	10	20	12 LEDS	83.3	>370	37	3 yrs

Primary Model	Model No.	Input Voltage (V)	LED QTY/M	Typical Wattage (W/M)	CCT	Section Size(mm)	Ra	Max.Length single feed(M)	Max.Length double feed(M)	Min.cutting unit	Min.cutting length (mm)	lm/M @4000K	lm/W	Warranty (yrs)
Side Bending (IP68)														
NF0817S	NF0817S-24-070-5W	DC24	70	5	2200K 2700K 3000K 3500K 4000K 5000K R G B P A O LY	08*16.5	>90	10	20	7 LEDS	100	>120	24	3 yrs
	NF0817S-24-120-10W	DC24	120	10	2200K 2700K 3000K 3500K 4000K 5000K R G B P A O LY	08*16.5	>90	10	20	12 LEDS	100	>120	12	3 yrs

Primary Model	Model No.	Input Voltage (V)	LED QTY/M	Typical Wattage (W/M)	CCT	Section Size(mm)	Ra	Max.Length single feed(M)	Max.Length double feed(M)	Min.cutting unit	Min.cutting length (mm)	lm/M @4000K	lm/W	Warranty (yrs)
Side Bending (IP68)														
NF1221S	NF1221S-24-072-15W	DC24	72	15	2200K 2700K 3000K 3500K 4000K 5000K G B P LY	11.5*21	>90	8	16	6 LEDS	83.3	>380	25	3 yrs
	NF1221S-24-060-12W	DC24	60	12	2200K 2700K 3000K 3500K 4000K 5000K G B P LY	11.5*21	>90	10	20	6 LEDS	100	>330	27	3 yrs
	NF1221S-24-060-7.2W	DC24	60	7.2	R A O	11.5*21	>90	15	30	10 LEDS	166.7	/	N/A	3 yrs
	NF1221S-24-072-5W	DC24	72	5	2200K 2700K 3000K 3500K 4000K 5000K R G B P A O	11.5*21	>90	15	30	12 LEDS	166.7	>130	26	3 yrs

Primary Model	Model No.	Input Voltage (V)	LED QTY/M	Typical Wattage (W/M)	CCT	Section Size(mm)	Ra	Max.Length single feed(M)	Max.Length double feed(M)	Min.cutting unit	Min.cutting length (mm)	lm/M @4000K	lm/W	Warranty (yrs)
Side Bending (IP68)														
NF1228S	NF1228S-24-072-15W	DC24	72	15	2200K 2700K 3000K 3500K 4000K 5000K G B P LY	11.5*28	>90	8	16	6 LEDS	83.3	>340	22	3 yrs
	NF1228S-24-060-12W	DC24	60	12	2200K 2700K 3000K 3500K 4000K 5000K G B P LY	11.5*28	>90	10	20	6 LEDS	100	>300	27	3 yrs
	NF1228S-24-060-7.2W	DC24	60	7.2	R A O	11.5*28	>90	15	30	10 LEDS	166.7	/	N/A	3 yrs
	NF1228S-24-072-5W	DC24	72	5	2200K 2700K 3000K 3500K 4000K 5000K R G B P A O	11.5*28	>90	15	30	12 LEDS	166.7	>120	24	3 yrs

NEW



NF1717T

- Flat surface with 120 degree beam angle
- Top bending with uniform and even light output
- High lumen output, up to 320lm/M
- Full silicone extrusion with IP68 level and high reliability with UV and yellowish resistant, even if used for a long time outdoor
- Max. run up to 20M application, at double feed, no brightness drop
- L70B50@50,000 hours

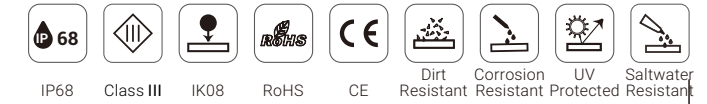

Technical Specification		
Model	NF1717T-24-120-9W	NF1717T-24-144-10W
Operating voltage	DC24	DC24
Power consumption	9W/M	10W/M
Working Mode	CV	CV
LED type	SMD3528	SMD3528
CRI	Ra>90	Ra>90
Section Size	16.5*16.5mm	16.5*16.5mm
LED Quantity	120pcs/M	144pcs/M
Available CCT	2200K/2700K/3000K/3500K/4000K/5000K	
Available Color	R/G/B/P/A/O	R/G/B/P/A/O
Min. cutting Unit	12 LEDs	12 LEDs
Min. cutting length	100mm	83.3mm
Max. length single feed	10M	10M
Max. length double feed	20M	20M
Photo-electric Parameters		
Model	NF1717T-24-120-9W	NF1717T-24-144-10W
CCT	LM/M	LM/M
R	>110lm	>120lm
G	>360lm	>390lm
B	>54lm	>60lm
A	>80lm	>90lm
O	>70lm	>80lm
P	>320lm	>360lm
LY	>340lm	/
2200K	>330lm	>360lm
2700K	>330lm	>360lm
3000K	>330lm	>360lm
3500K	>340lm	>370lm
4000K	>340lm	>370lm
5000K	>360lm	>400lm

Ordering Code

NF1717T - 24 - 120 - 9W - 2.2K - S - 01 - SM

Primary Model	Input Voltage(V)	LED QTY/M	Typical Wattage(W/m)	Color / Light Color	Connector entry type	Connector direction	Cable connector type		
NF1717T	24 DC24V	120	9W	2200K	2.2K	Side entry	S Right	01 Male connector cable	SM
		120pcs	10W	2700K	2.7K	Direct entry	D Left	02 Female connector cable	SF
144	3000K	3K		Bottom entry	B Double	03 Male & female connector cable	SMF		
144pcs	3500K	3.5K							
	4000K	4K							
	5000K	5K							
	Red	R							
	Green	G							
	Blue	B							
	Amber	A							
	Orange	O							
	Pink	P							
	Lemon Yellow	LY							

Tunable, RGB, RGBW, DMX version are also available(To be ordered separately)

NEW

Construction

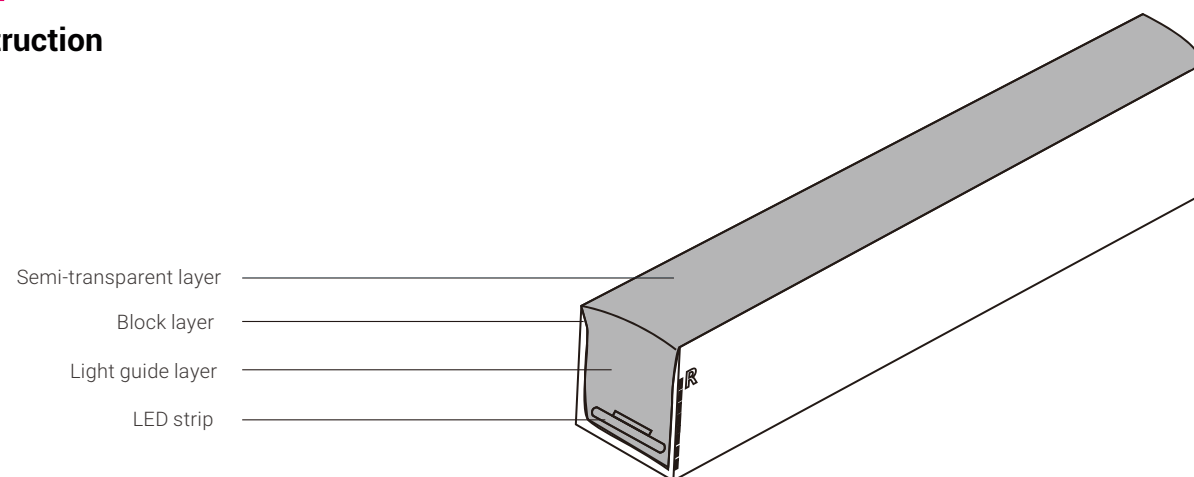

Physical Specification

Light profile

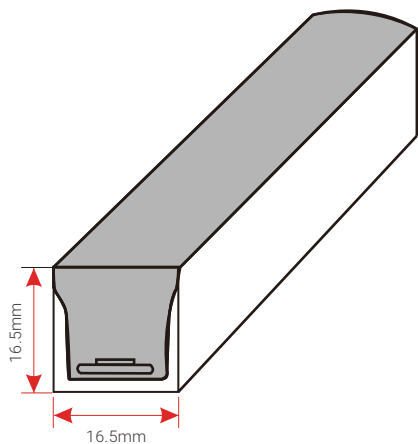

Bending direction

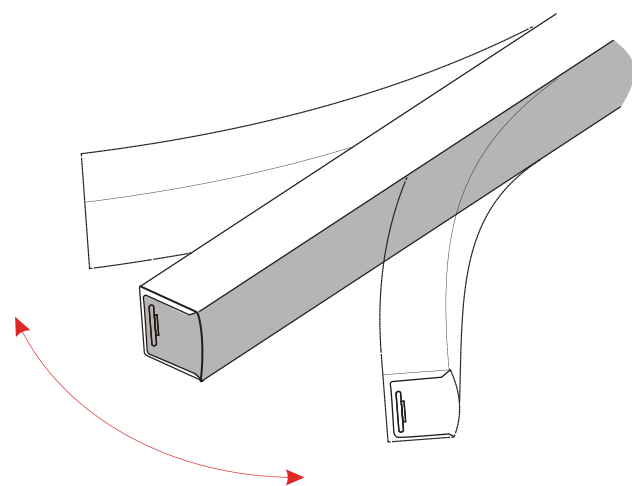

Min. bending diameter

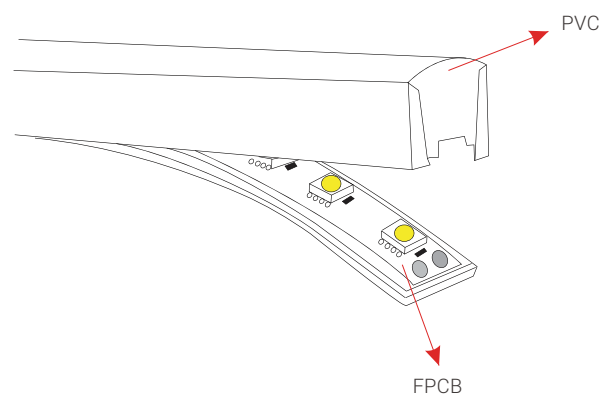
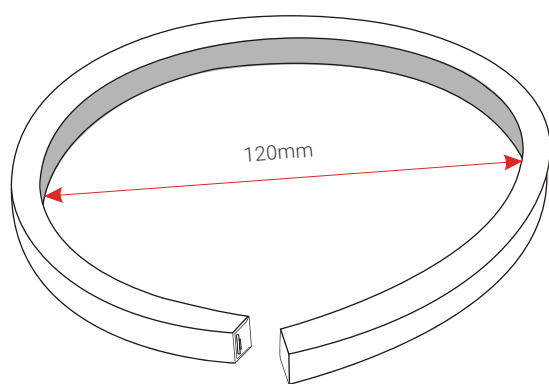

Mould injection connector

(IP68 Factory Assembly only)

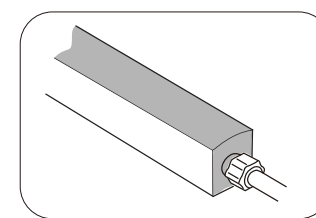

- ① MJ-1717-A-D01
- ② MJ-1717-A-D01SM
- ③ MJ-1717-A-D02
- ④ MJ-1717-A-D02SF
- ⑤ MJ-1717-A-D03
- ⑥ MJ-1717-A-D03SMF

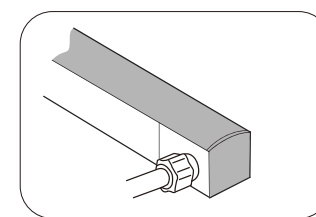
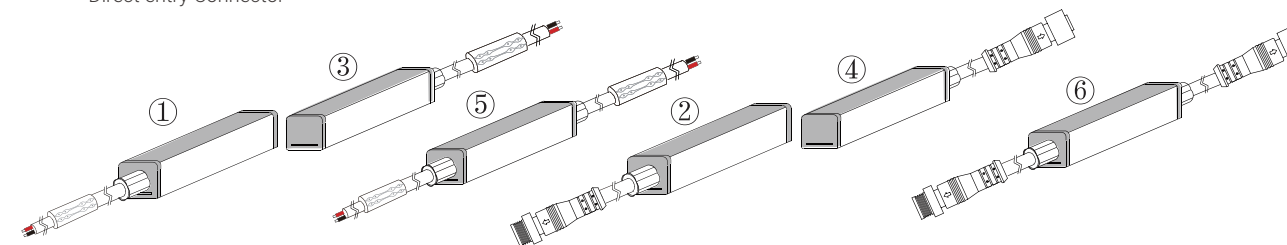
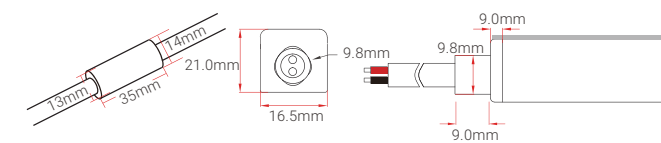

- ① MJ-1717-A-S01
- ② MJ-1717-A-S01SM
- ③ MJ-1717-A-S02
- ④ MJ-1717-A-S02SF
- ⑤ MJ-1717-A-S03
- ⑥ MJ-1717-A-S03SMF

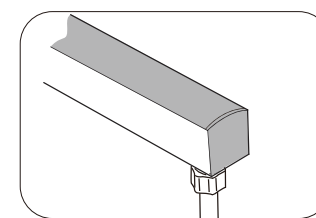
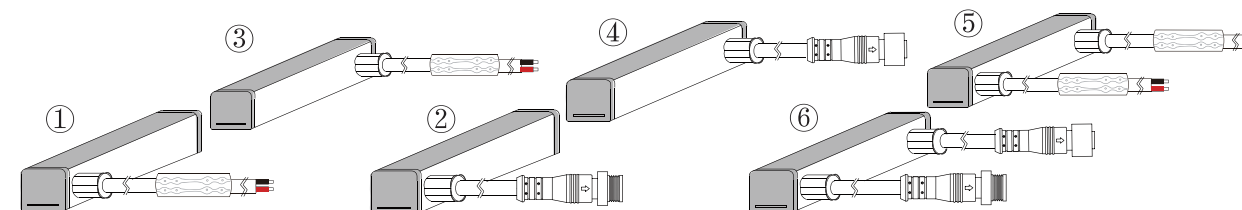
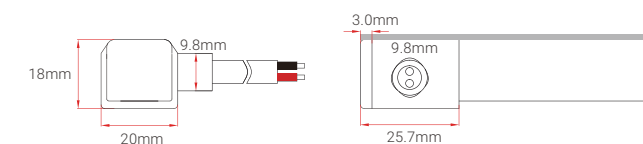

- ① MJ-1717-A-B01
- ② MJ-1717-A-B01SM
- ③ MJ-1717-A-B02
- ④ MJ-1717-A-B02SF
- ⑤ MJ-1717-A-B03
- ⑥ MJ-1717-A-B03SMF

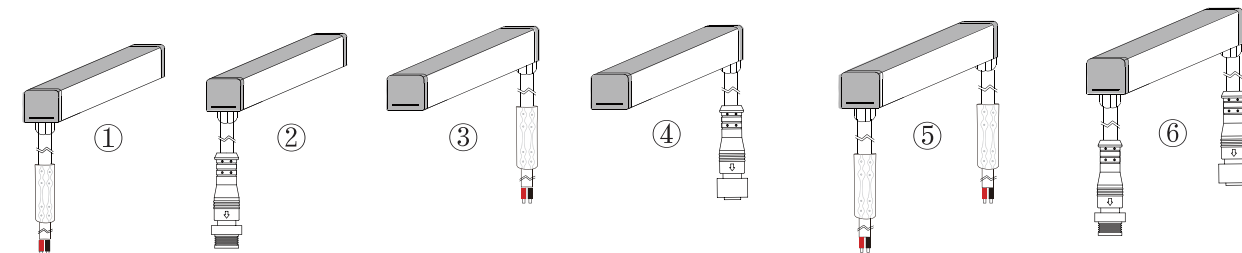
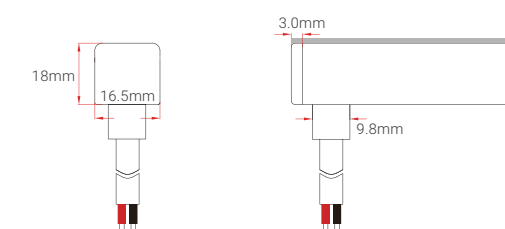

NEW

Mould injection connector

(IP68 Factory Assembly only)

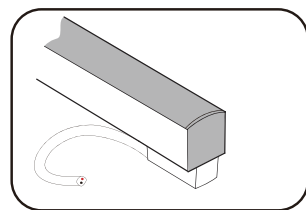

- ① MJ-1717-A-L01
- ② MJ-1717-A-L01SM
- ③ MJ-1717-A-L03
- ④ MJ-1717-A-L03SMF

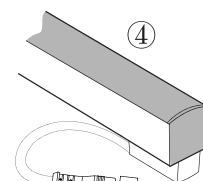
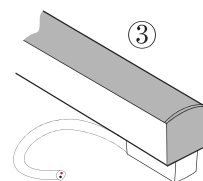
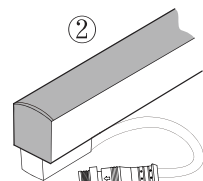
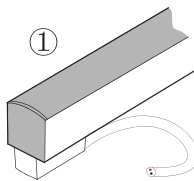

Mould injection Jumper

(IP68 Factory Assembly only)

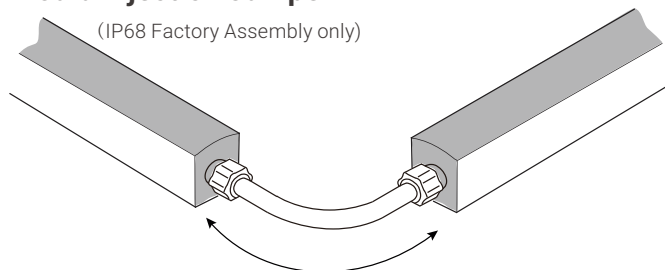

0.3m cable length

DIY snap splice connector (IP67 Only)

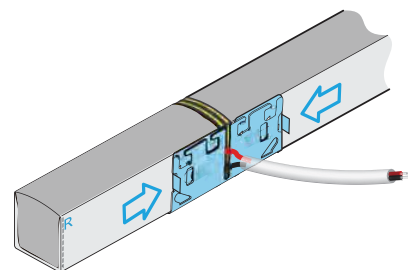

Model: DIY-SN-SP-1717-A

DIY Screw & Snap connector Kit (IP67 Only)

DIY screw splice connector kit

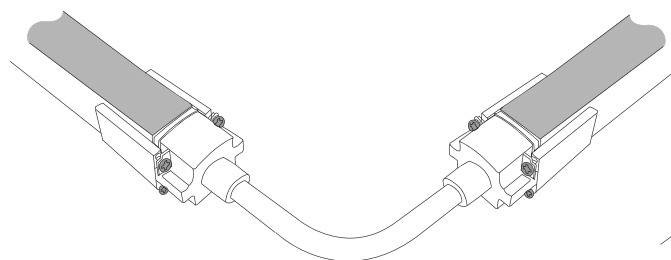

Model: DIY-SC-FR-1717-D-01-A (Right)
DIY-SC-FR-1717-D-02-A (Left)

DIY screw connector & End cap kit

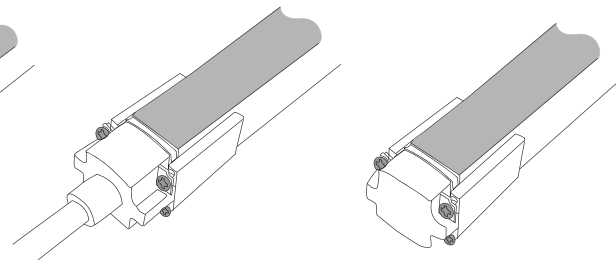

Model: DIY-SC-END-1717

DIY snap splice connector kit

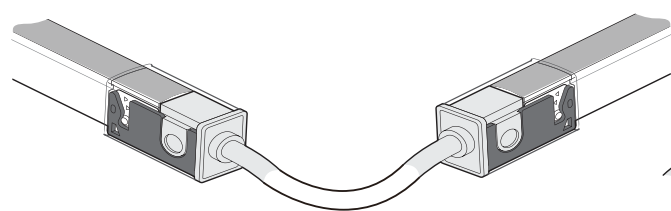

Model: DIY-SN-FR-1717-D-01-A (Right)
DIY-SN-FR-1717-D-02-A (Left)

DIY snap connector & end cap kit

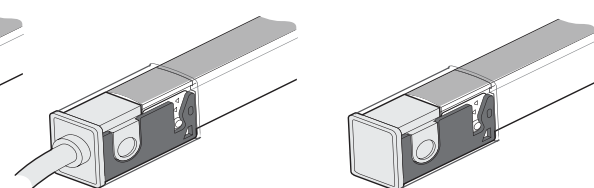

DIY-SN-END-1717-01 (Right)
DIY-SN-END-1717-02 (Left)

Other Accessories

Female & Male Connector

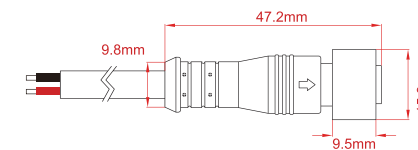

Female connector wire
SYZ-M12-M-2C-075-W

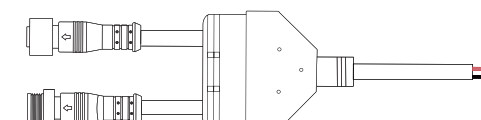

Middle power connector
MID-CNR-A-1T2

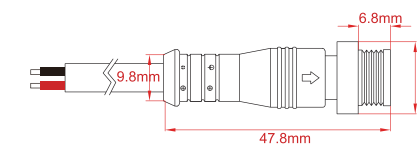
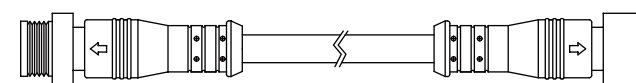

Male connector wire
SYZ-M12-F-2C-075-W

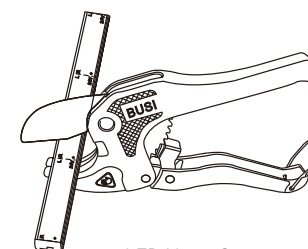

LED Neon Cutter
ACC-TOOL-C1

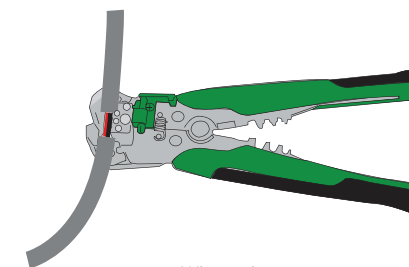

Wire stripper
ACC-TOOL-WS01

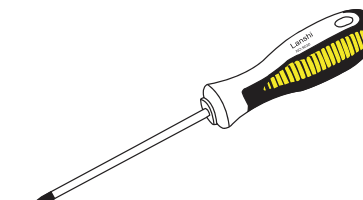

Screwdriver
ACC-TOOL-C2



Mean Well Transformer
Non-waterproof Series

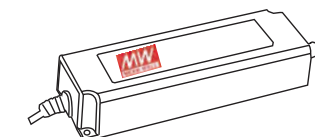

Mean Well Transformer
Waterproof Series



Female & male wire connector
KJ-M12-2P-F/ KJ-M12-2P-M



Silicone Rubber
K-5905

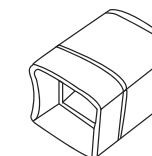

PVC End Cap
DIY-PVC-END-1717



Assistant Tool A
CC-TOOL-C3

NEW

Mounting Profile

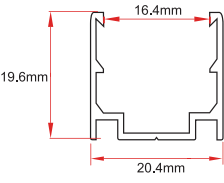
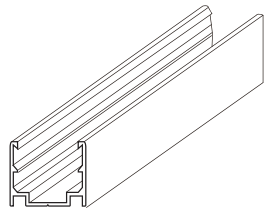
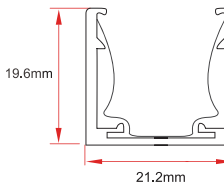
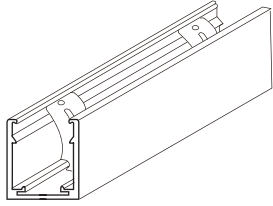
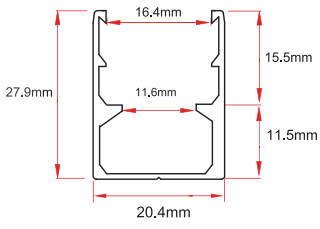
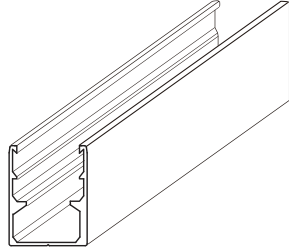
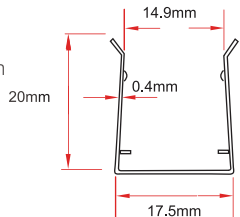
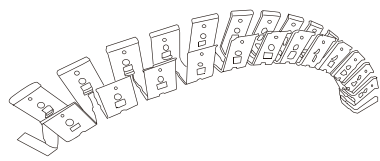
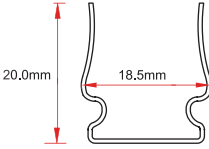
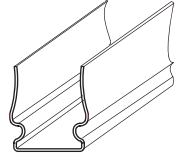
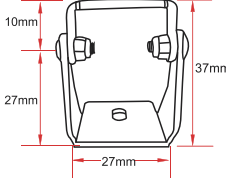
Model	Description	Dimension	Drawing
ALC1717S02	Compatibility: NF1717T Length option: 1m, 2m, 35mm Material: Aluminum alloy Optional color: AS/AB/PW Type: Standard		
ALC1717S03	Use for: NF1717T Length option: 1m, 2m, 35mm Material: Aluminum alloy Optional color: AS/AB/PW Type: Anti-drop for upside down installation		
ALC1717H01	Use for: NF1717T Length option: 1m, 2m, 35mm Material: Aluminum alloy Optional color: AS/AB/PW Type: Cable hiding		
SSC1717FLX	Use for: NF1717T Length option: 10cm, 30cm, 50cm, 100cm Material: Stainless steel Optional color: Polished Type: Flexible		
SSC1717S01	Use for: NF1717T Length option: 5cm Material: Stainless steel Optional color: Natural color Type: 316 stainless steel		
ACC-HX-S2830C2	Use for mounting channel for angle adjustment		

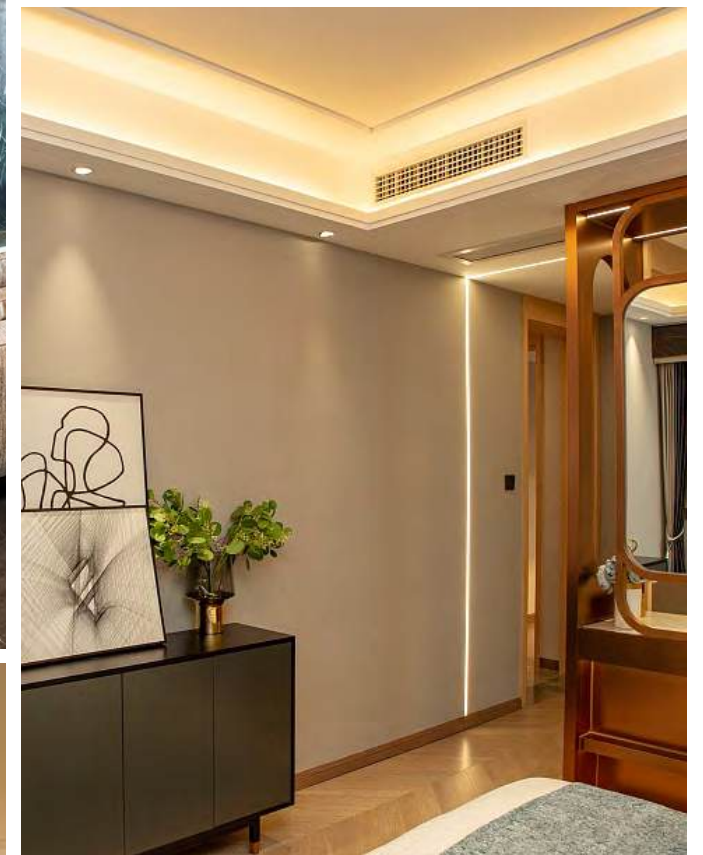
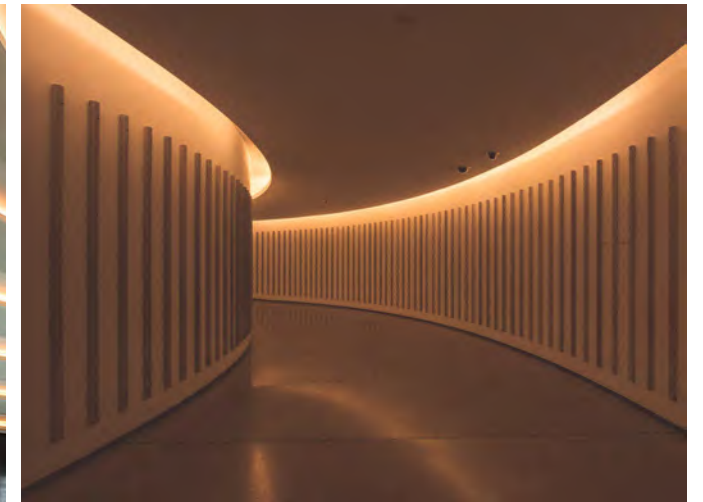

Application

Suitable for indoor and outdoor decorative lighting, architectural outline lighting, cove lighting, sign and advertising lighting.

NEW

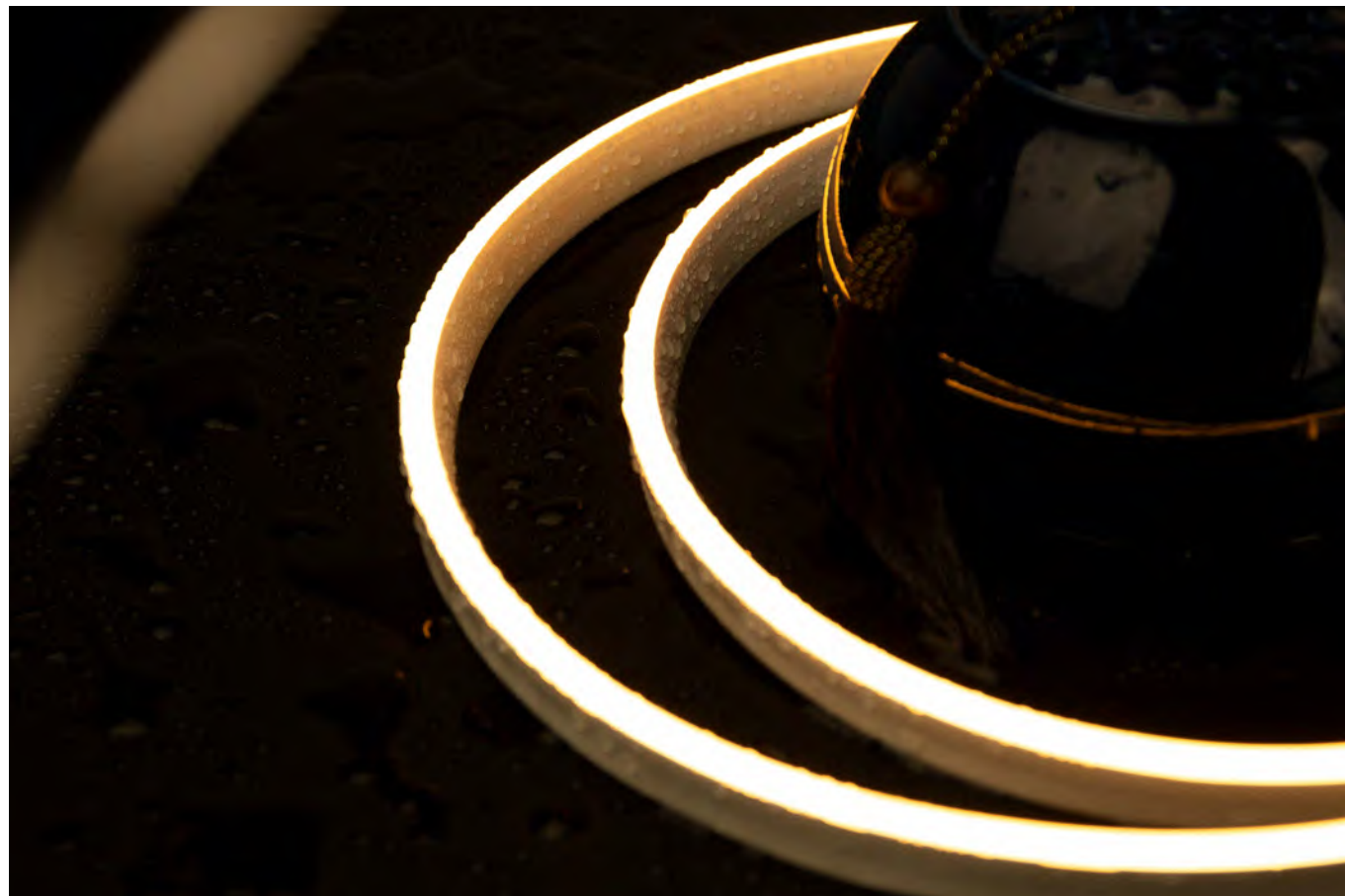

NF0817S

- Flat surface with 120 degree beam angle
- Top bending with uniform and even light output
- High lumen output, up to 130lm/M
- Full silicone extrusion with IP68 level and high reliability with UV and yellowish resistant, even if used for a long time outdoor
- Max. run up to 20M application, at double feed, no brightness drop
- L70B50@50,000 hours

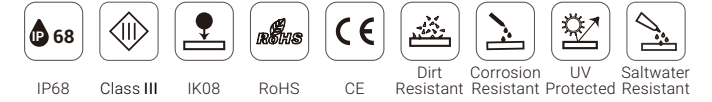
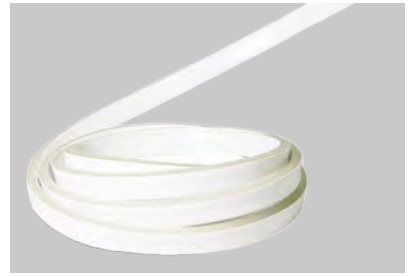

Technical Specification		
Model	NF0817S-24-070-5W	NF0817S-24-120-10W
Operating voltage	DC24	DC24
Power consumption	5W/M	10W/M
Working Mode	CV	CV
LED type	SMD2835	SMD2835
CRI	Ra>90	Ra>90
Section Size	08*16.5mm	08*16.5mm
LED Quantity	70pcs/M	120pcs/M
Available CCT	2200K/2700K/3000K/3500K/4000K/5000K	
Available Color	R/G/B/LY/P/A/O	R/G/B/LY/P/A/O
Min. cutting Unit	7 LEDs	12 LEDs
Min. cutting length	100mm	100mm
Max. length single feed	10M	10M
Max. length double feed	20M	20M
Photo-electric Parameters		
Model	NF0817S-24-070-5W	NF0817S-24-120-10W
CCT	lm/M	lm/M
R	>40lm	>40lm
G	>70lm	>70lm
B	>13lm	>13lm
A	>40lm	>40lm
O	>32lm	>32lm
P	>55lm	>55lm
LY	>90lm	>90lm
2200K	>110lm	>110lm
2700K	>110lm	>110lm
3000K	>110lm	>110lm
3500K	>120lm	>120lm
4000K	>120lm	>120lm
5000K	>130lm	>130lm

Ordering Code

NF0817S - 24 - 070 - 5W - 2.2K - S - 01 - SM

Primary Model	Input Voltage(V)	LED QTY/M	Typical Wattage(W/m)	Color / Light Color	Connector entry type	Connector direction	Cable connector type			
NF0817S	24 DC24V	070 70pcs	5W	2200K	2.2K	Side entry	S Right	01 Male connetor cable	SM	
				2700K	2.7K	Direct entry	D Left	02 Female connector cable	SF	
		120 120pcs	10W	3000K	3K	Bottom entry	B Double	03	Male & female connector cable	SMF
				3500K	3.5K					
				4000K	4K	Bare wire	Blank			
				5000K	5K					
				Red	R					
				Green	G					
				Blue	B					
				Amber	A					
				Orange	O					
				Pink	P					
		Lemon Yellow	LY							

NEW

Construction

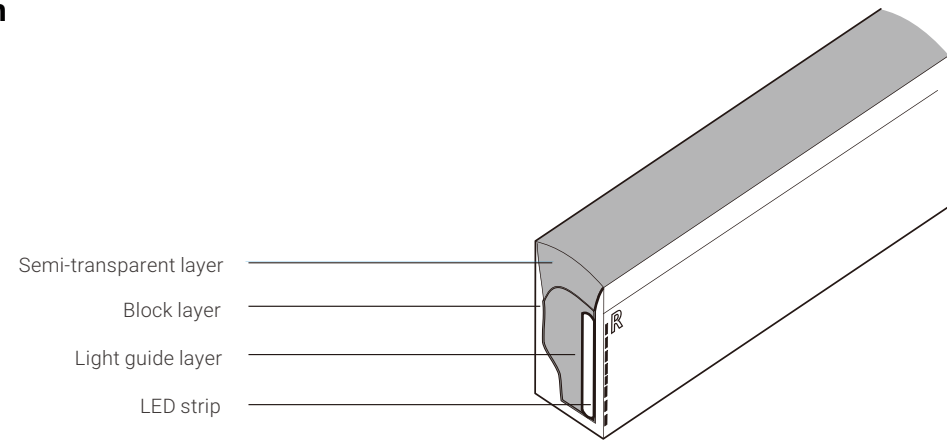

Physical Specification

Light profile

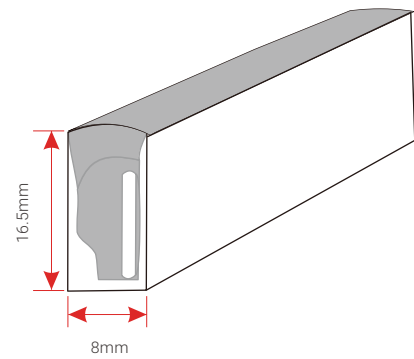

Bending direction

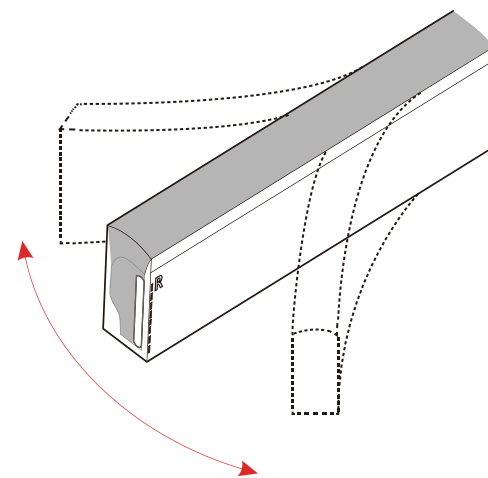

Min. bending diameter

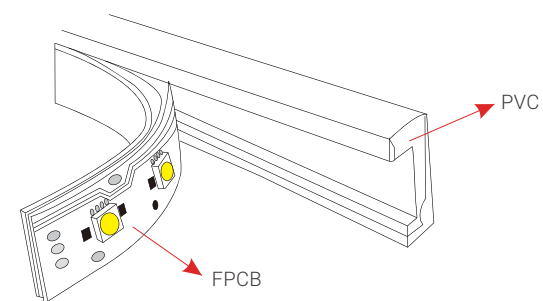
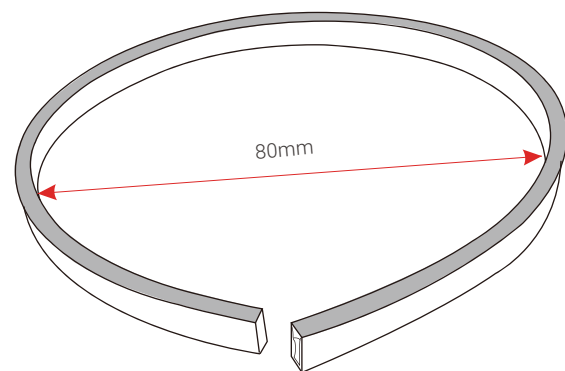

Mould injection connector

(IP68 Factory Assembly only)

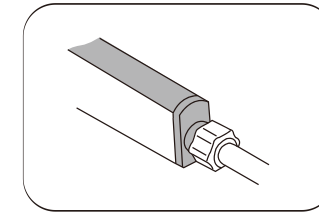

- ① MJ-0817-A-D01
- ② MJ-0817-A-D01SM
- ③ MJ-0817-A-D02
- ④ MJ-0817-D02SF
- ⑤ MJ-0817-A-D03
- ⑥ MJ-0817-A-D03SMF

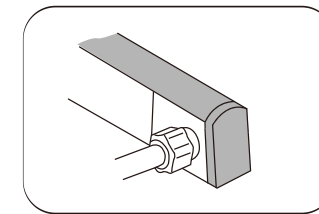
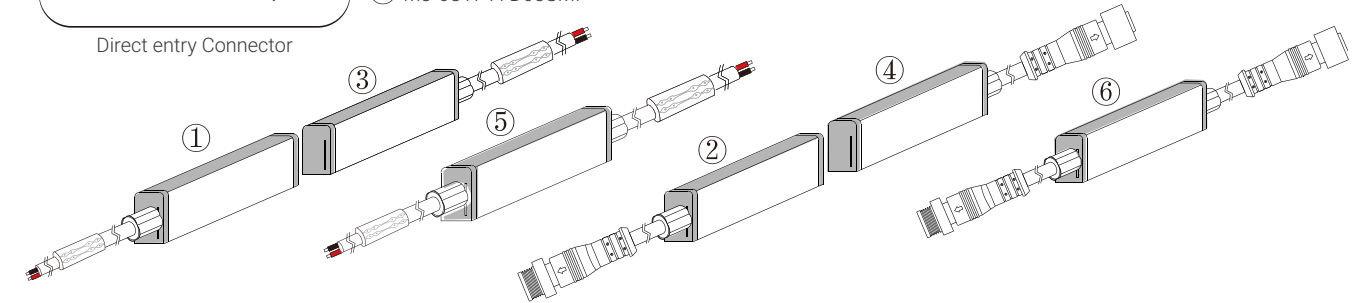
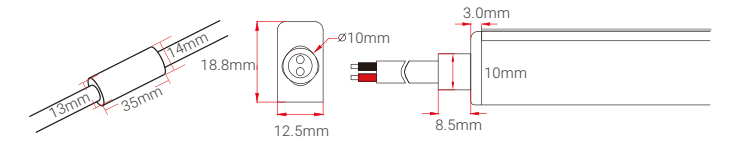

- ① MJ-0817-A-S01
- ② MJ-0817-A-S01SM
- ③ MJ-0817-A-S02
- ④ MJ-0817-A-S02SF
- ⑤ MJ-0817-A-S03
- ⑥ MJ-0817-A-S03SMF

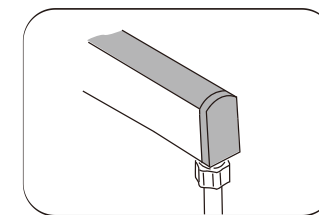
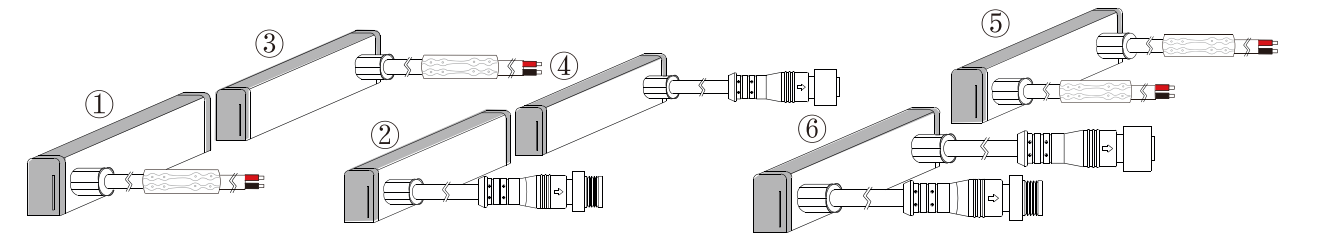
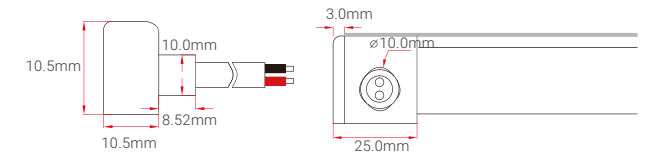

- ① MJ-0817-A-B01
- ② MJ-0817-A-B01SM
- ③ MJ-0817-A-B02
- ④ MJ-0817-A-B02SF
- ⑤ MJ-0817-A-B03
- ⑥ MJ-0817-A-B03SFM

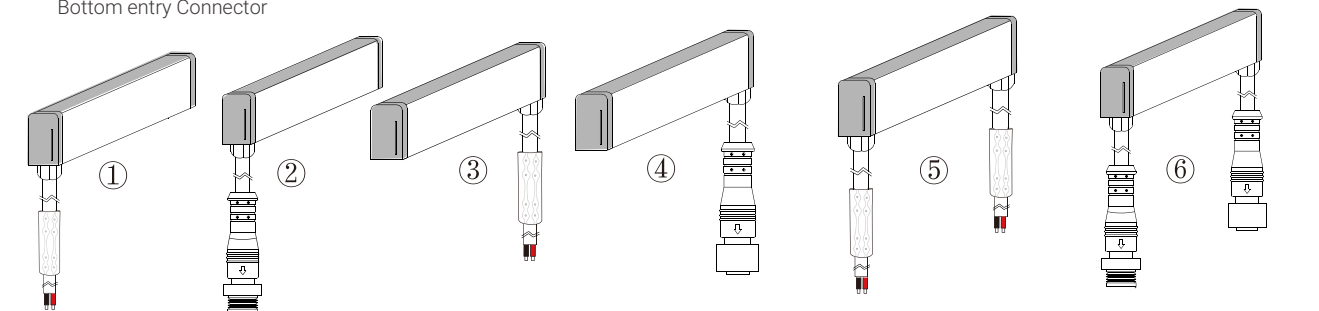
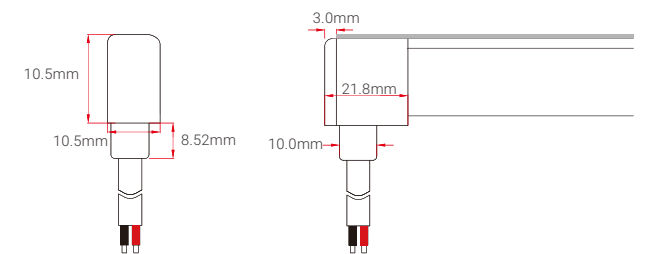

NEW

Other Accessories

Female & Male Connector

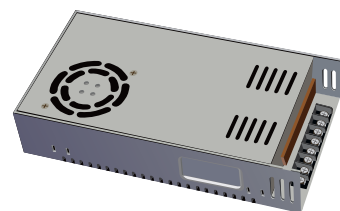
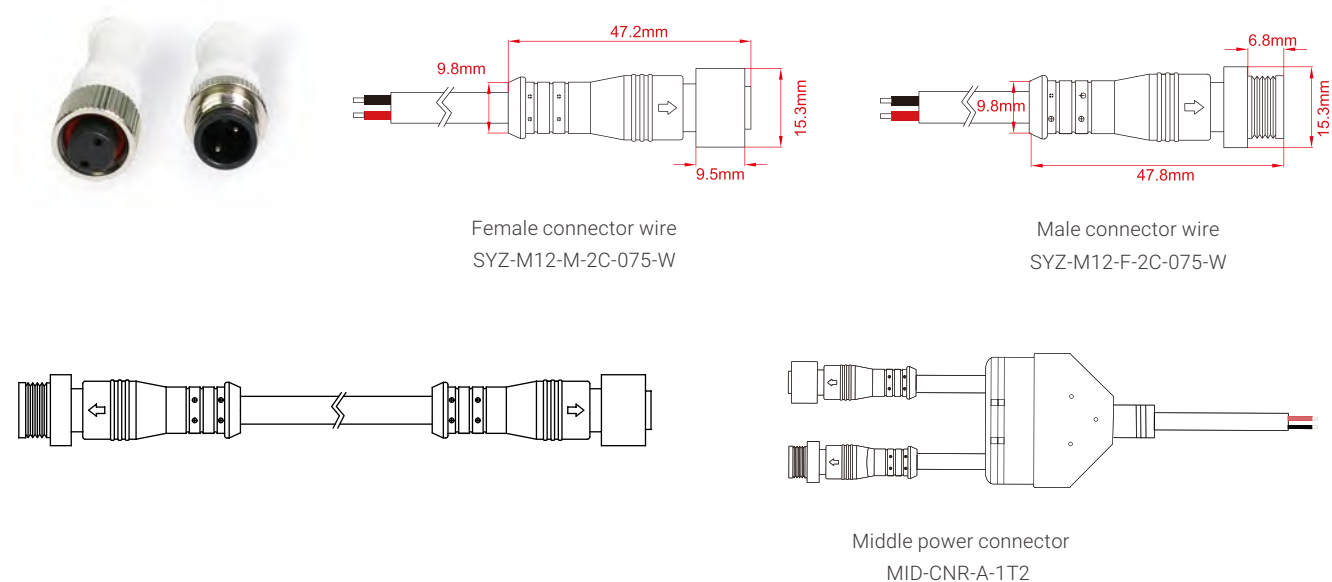

Mean Well Transformer
Non-waterproof Series

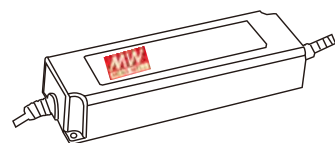

Mean Well Transformer
Waterproof Series



Female & male wire connector
KJ-M12-2P-F/ KJ-M12-2P-M

Mounting Channel

Model	Description	Dimension	Drawing
ALC0817S01	Use for: NF0817S Length option: 1m, 2m, 35mm Material: Aluminum alloy Optional color: AS/AB/PW Type: Standard		

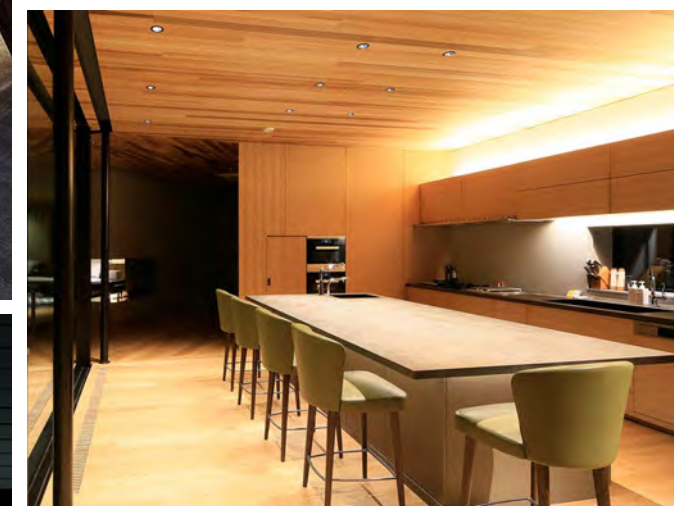

Application

Suitable for indoor and outdoor decorative lighting, architectural outline lighting, cove lighting, sign and advertising lighting.

! NEW

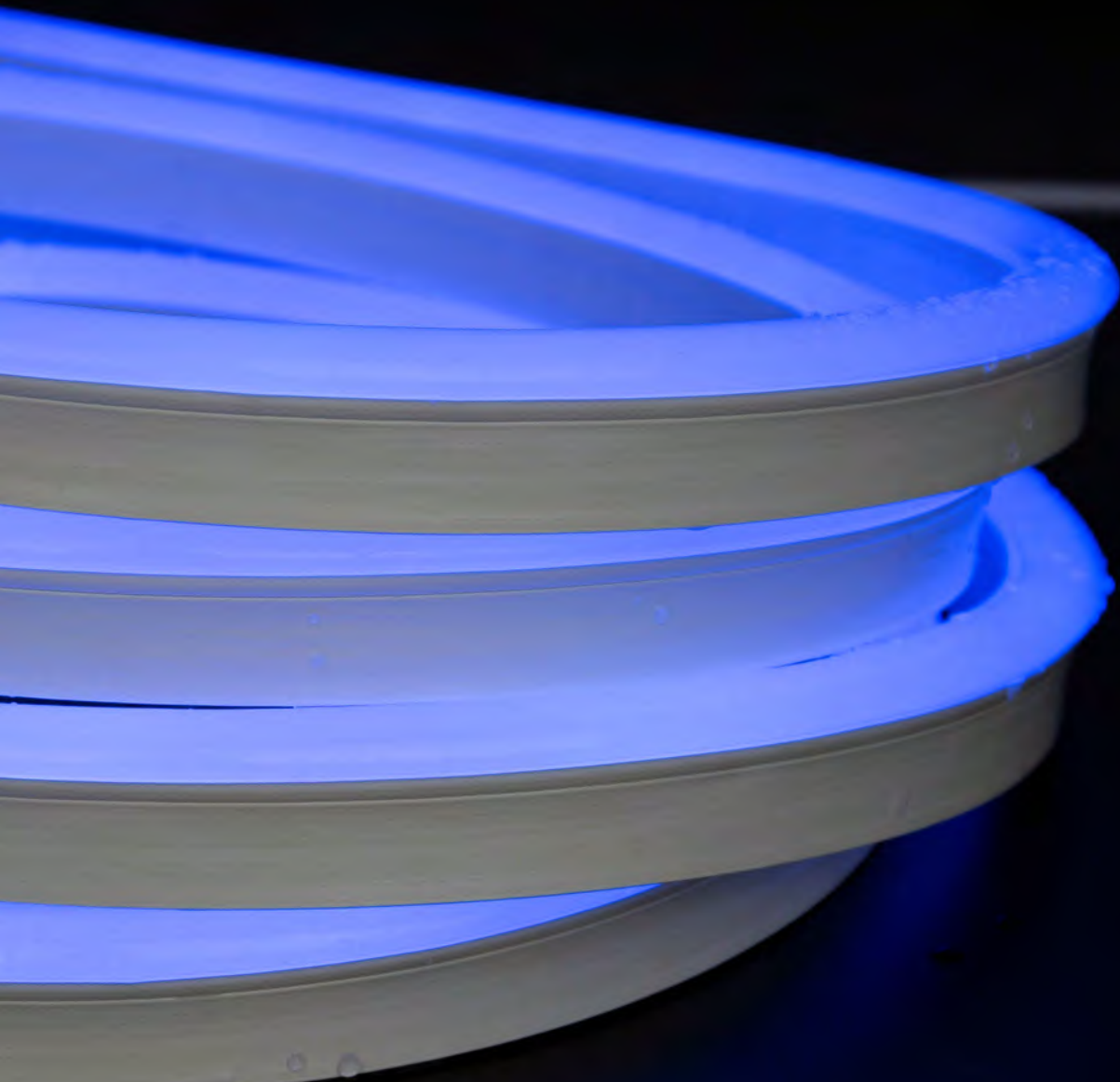

NF1221S

- Flat surface with 120 degree beam angle
- Top bending with uniform and even light output
- High lumen output, up to 390lm/M
- Full silicone extrusion with IP68 level and high reliability with UV and yellowish resistant, even if used for a long time outdoor
- Max. run up to 20M application, at double feed, no brightness drop
- L70B50@50,000 hours

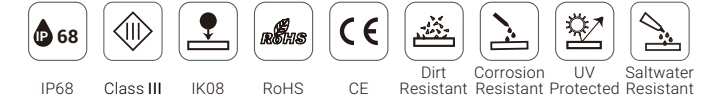

Technical Specification				
Model	NF1221S-24-072-15W	NF1221S-24-060-12W	NF1221S-24-060-7.2W	NF1221S-24-072-5W
Operating voltage	DC24	DC24	DC24	DC24
Power consumption	15W/M	12W/M	7.2W/M	5W/M
Working Mode	CV	CV	CV	CV
LED type	SMD5050	SMD5050	SMD5050	SMD3528
CRI	Ra>90	Ra>90	Ra>90	Ra>90
Section Size	11.5*21mm	11.5*21mm	11.5*21mm	11.5*21mm
LED Quantity	72pcs/M	60pcs/mM	60pcs/M	72pcs/M
Available CCT	2200K/2700K/3000K/3500K/4000K/5000K		/	2200K/2700K/3000K/3500K/4000K/5000K
Available Color	G/B/LY/P	G/B/LY/P	R/A/O	R/G/B/P/A/O
Min. cutting Unit	6 LEDS	6 LEDS	10 LEDS	12 LEDS
Min. cutting length	83.3mm	100mm	166.7mm	166.7mm
Max. length single feed	8M	10M	15M	15M
Max. length double feed	16M	20M	30M	30M
Photo-electric Parameters				
Model	NF1221S-24-072-15W	NF1221S-24-060-12W	NF1221S-24-060-7.2W	NF1221S-24-072-5W
CCT	LM/M	LM/M	LM/M	LM/M
R	/	/	>110lm	>144lm
G	>230lm	>200lm	/	>80lm
B	>40lm	>35lm	/	>14lm
A	/	/	>110lm	>44lm
O	/	/	>90lm	>35lm
P	>180lm	>150lm	/	>60lm
LY	>300lm	>250lm	/	/
2200K	>330lm	>280lm	/	>120lm
2700K	>330lm	>280lm	/	>120lm
3000K	>330lm	>280lm	/	>120lm
3500K	>380lm	>330lm	/	>130lm
4000K	>380lm	>330lm	/	>130lm
5000K	>390lm	>350lm	/	>140lm

Ordering Code

Primary Model	Input Voltage(V)	LED QTY/M	Typical Wattage(W/m)	Color / Light Color	Connector entry type	Connector direction	Cable connector type		
NF1221S	24 DC24V	060 60pcs	5W	2200K	2.2K	Side entry	Right	01 Male connector cable	SM
			7.2W	2700K	2.7K	Direct entry	Left	02 Female connector cable	SF
				3000K	3K	Bottom entry	Double	03 Male & female connector cable	SMF
		3500K	3.5K						
		12W	4000K	4K					
			5000K	5K					
			Red	R					
			Green	G					
			Blue	B					
			Amber	A					
		15W	Orange	O					
			Pink	P					
Lemon Yellow	LY								

Tunable, RGB, RGBW, DMX version are also available(To be ordered separately)

NEW

Construction

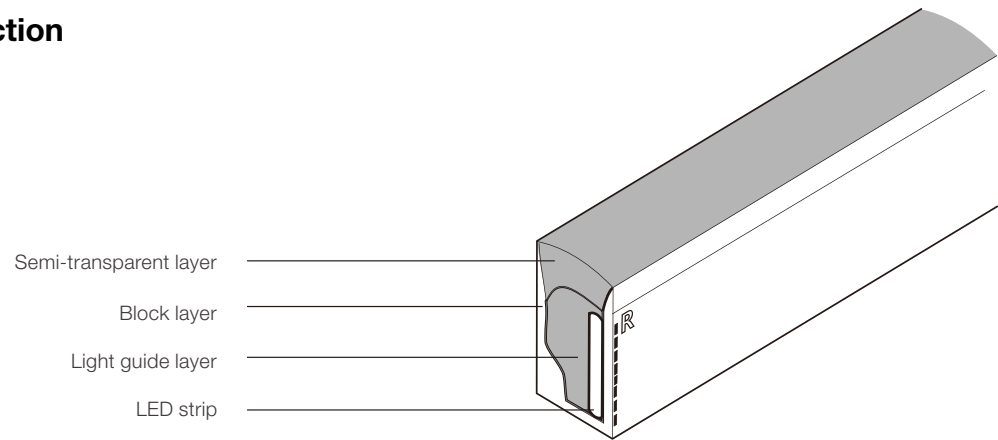

Physical Specification

Light profile

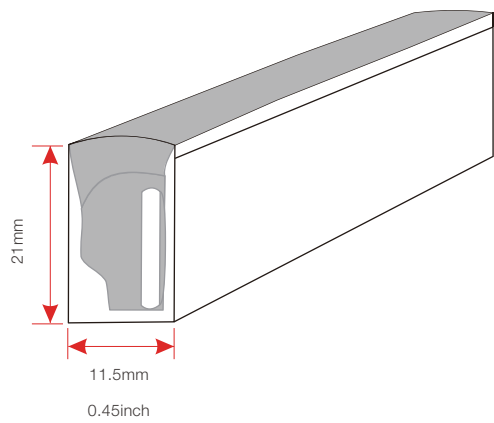

Bending direction

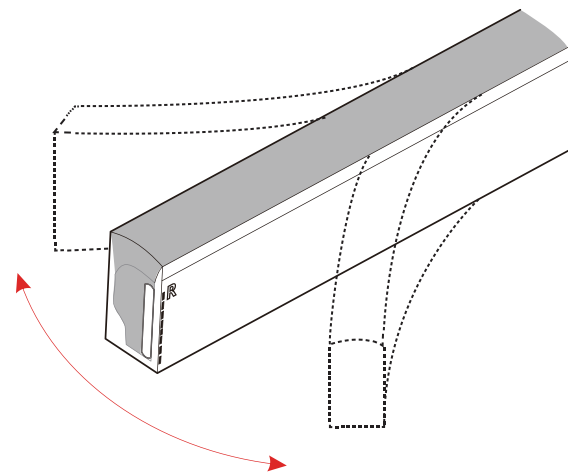

Min. bending diameter

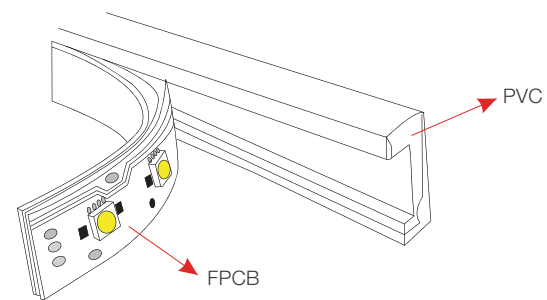
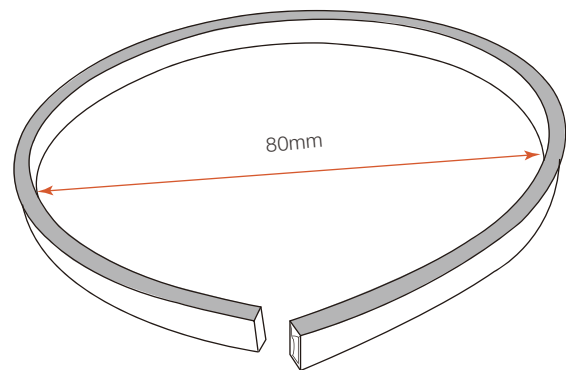

Mould injection connector

(IP68 Factory Assembly only)

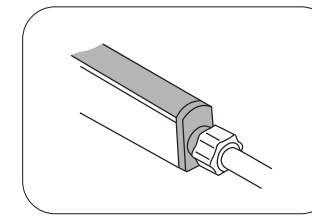

- ① MJ-1221-A-D01
- ② MJ-1221-A-D01SM
- ③ MJ-1221-A-D02
- ④ MJ-1221-A-D02SF
- ⑤ MJ-1221-A-D03
- ⑥ MJ-1221-A-D03SMF

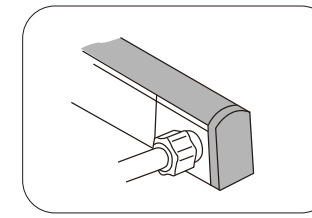
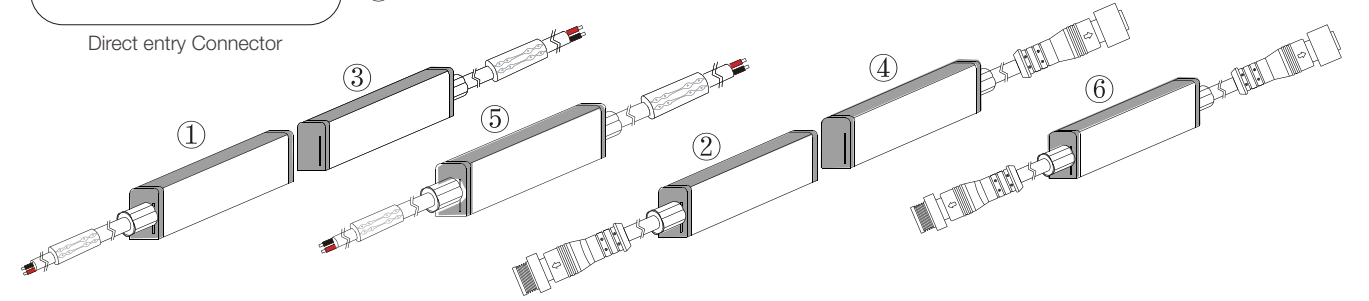
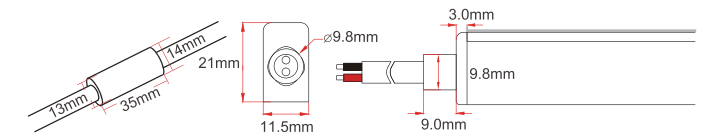

- ① MJ-1221-A-S01
- ② MJ-1221-A-S01SM
- ③ MJ-1221-A-S02
- ④ MJ-1221-A-S02SF
- ⑤ MJ-1221-A-S03
- ⑥ MJ-1221-A-S03SMF

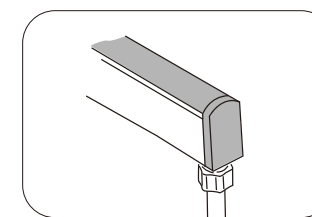
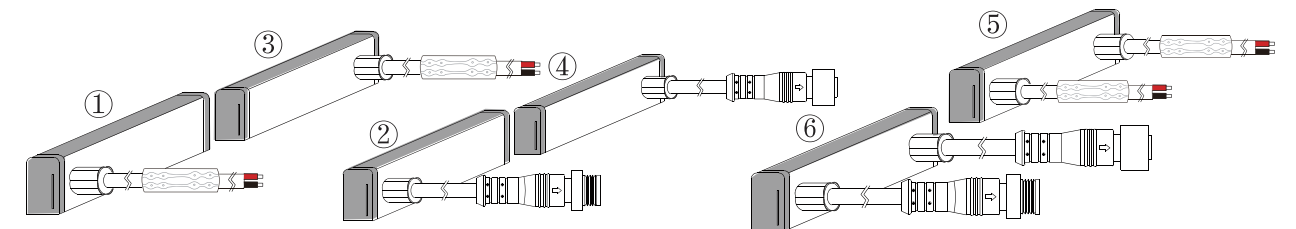
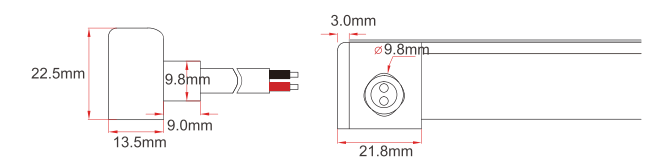

- ① MJ-1221-A-B01
- ② MJ-1221-A-B01SM
- ③ MJ-1221-A-B02
- ④ MJ-1221-A-B02SF
- ⑤ MJ-1221-A-B03
- ⑥ MJ-1221-A-B03SMF

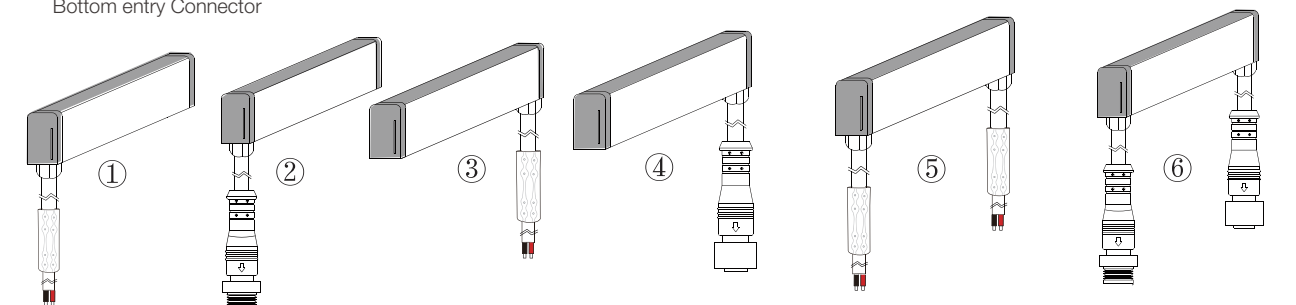
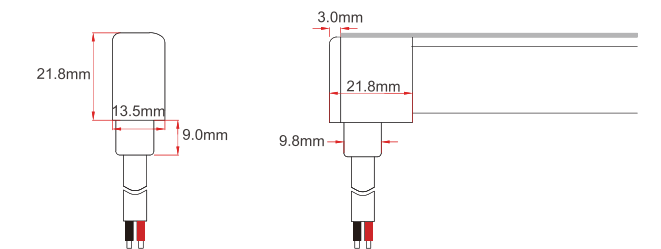

NEW

DIY Screw & Snap Connector Kit

Mould injection Jumper

(IP68 Factory Assembly only)

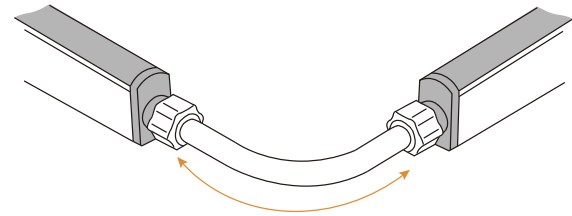

0.3m cable length

Mould injection Jumper

(P68 Factory Assembly only)

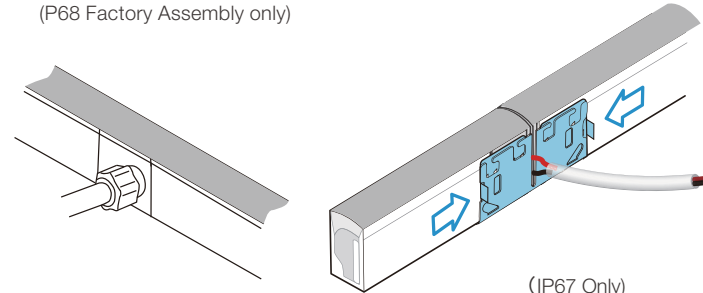

(IP67 Only)
DIY snap splice connector

DIY screw splice connector kit

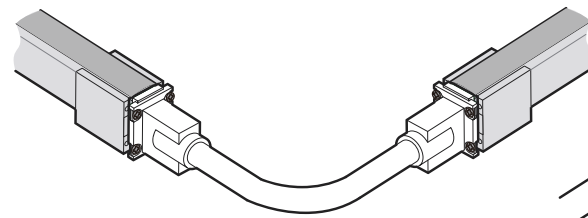

DIY screw connector & End cap kit

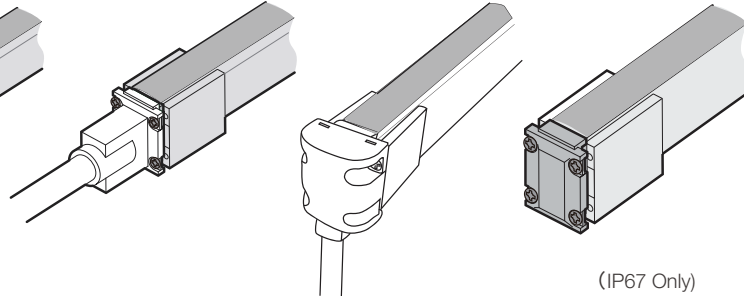

(IP67 Only)

DIY screw splice connector kit

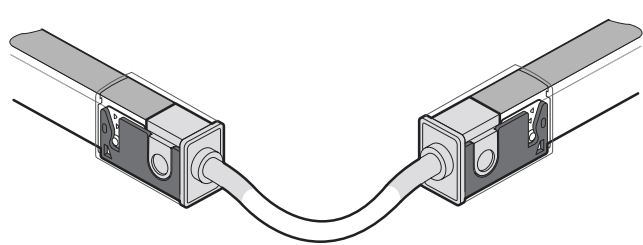

DIY screw connector & End cap kit

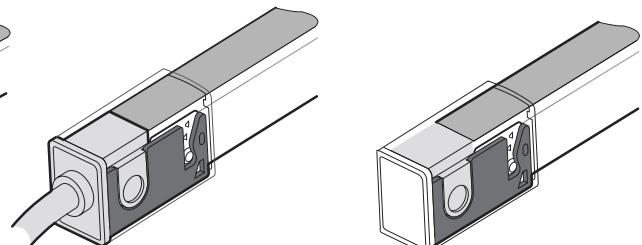

(IP67 Only)

DIY snap front connector

DIY snap end cap

Type

Model

- Middle injection Connector
- DIY snap splice connector
- DIY screw connector kit Jumper
- DIY screw front connector
- DIY screw end cap kit
- DIY snap front connector
- DIY screw end cap kit

- MJ-1221-A-M01-06
- DIY-SC-Middle-1221/1228
- DIY-SC-EXT-1221/1228-D-A
- DIY-SC-FR-1221/1228-D-01-A (Right)
- DIY-SC-FR-1221/1228-D-02-A (Left)
- DIY-SC-FR-1221/1228-B-01-A (Right)
- DIY-SC-FR-1221/1228-B-02-A (Left)
- DIY-SC-END-1221/1228

- DIY-SN-FR-1221/1228-D-01-A (Right)
- DIY-SN-FR-1221/1228-D-02-A (Left)
- DIY-SN-END-1221/1228-01 (Right)
- DIY-SN-END-1221/1228-02 (Left)

Other Accessories

Female & Male Connector

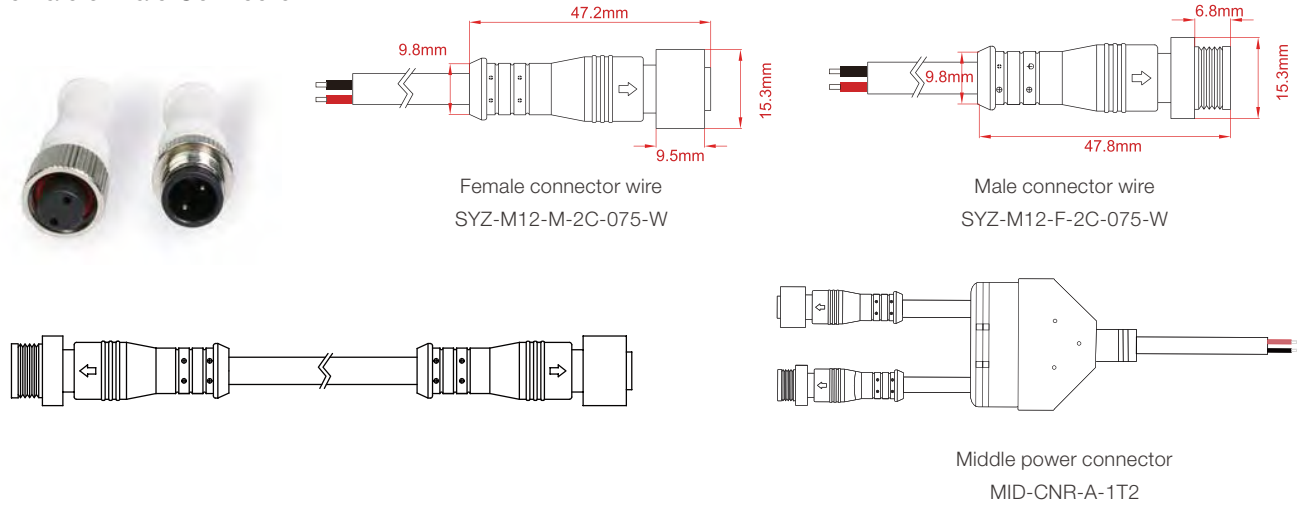

<p>LED Neon Cutter ACC-TOOL-C1</p>	<p>Wire stripper ACC-TOOL-WS01</p>	<p>Screwdriver ACC-TOOL-C2</p>
<p>Mean Well Transformer Non-waterproof Series</p>	<p>Mean Well Transformer Waterproof Series</p>	<p>Female & male wire connector KJ-M12-2P-F/ KJ-M12-2P-M</p>
<p>Silicone Rubber K-5905</p>	<p>PVC End Cap DIY-PVC-END-1221</p>	<p>Assistant Tool A CC-TOOL-C3</p>

NEW

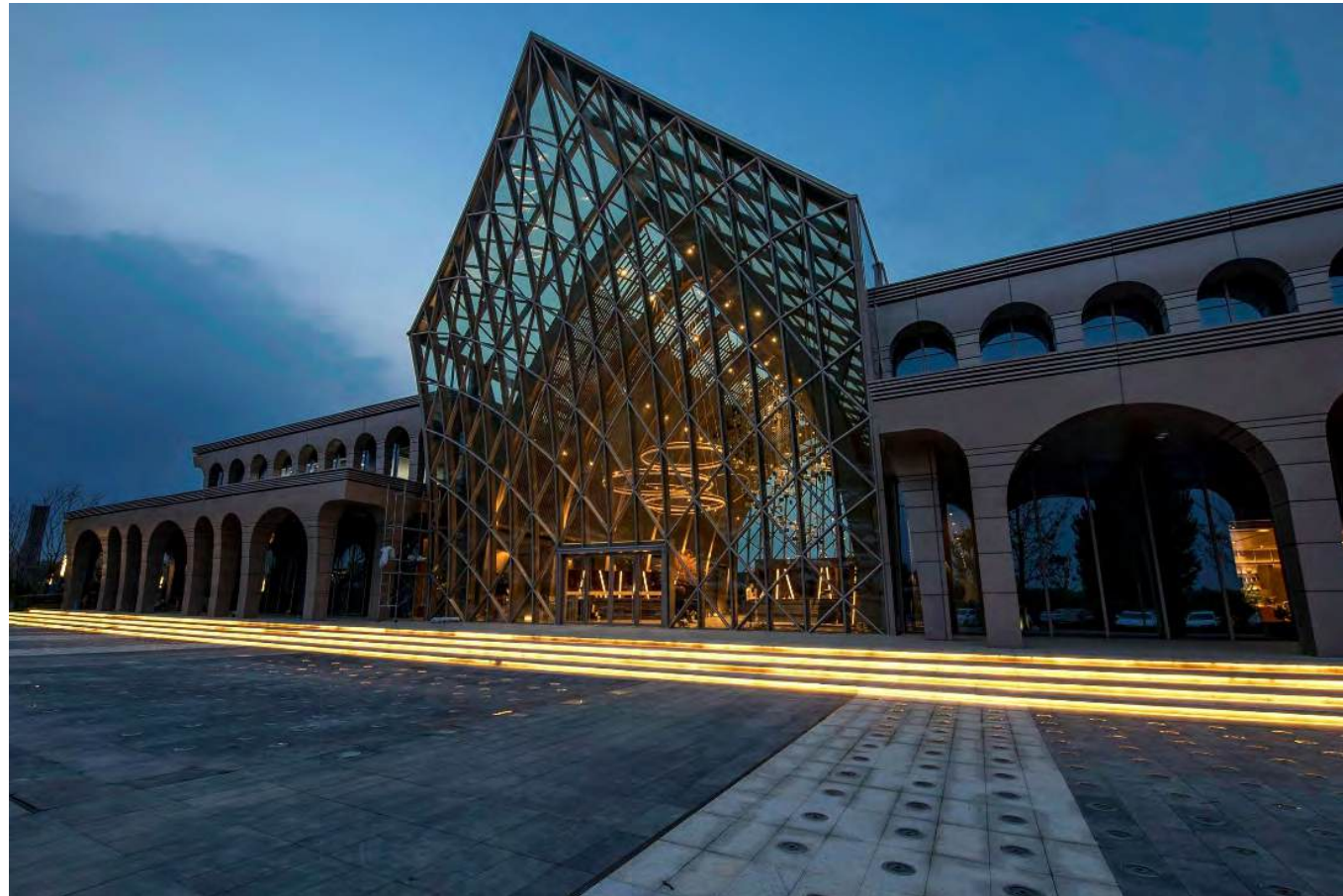

NF1228S

- Flat surface with 270 degree beam angle
- Top bending with uniform and even light output
- High lumen output, up to 350lm/M
- Full silicone extrusion with IP68 level and high reliability with UV and yellowish resistant, even if used for a long time outdoor
- Max. run up to 30M application, at double feed, no brightness drop
- L70B50@50,000 hours

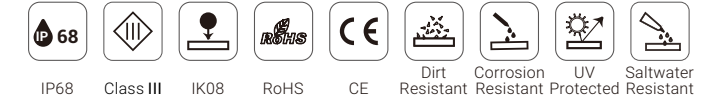

Technical Specification				
Model	NF1228S-24-072-15W	NF1228S-24-060-12W	NF1228S-24-060-7.2W	NF1228S-24-072-5W
Operating voltage	DC24	DC24	DC24	DC24
Power consumption	15W/M	12W/M	7.2W/M	5W/M
Working Mode	CV	CV	CV	CV
LED type	SMD5050	SMD5050	SMD5050	SMD3528
CRI	Ra>90	Ra>90	Ra>90	Ra>90
Section Size	11.5*28mm	11.5*28mm	11.5*28mm	11.5*28mm
LED Quantity	72pcs/M	60pcs/M	60pcs/M	72pcs/M
Available CCT	2200K/2700K/3000K/3500K/4000K/5000K		/	/
Available Color	G/B/LY/P	G/B/LY/P	R/A/O	R/G/B/P/A/O
Min. cutting Unit	6 LEDs	6 LEDs	10 LEDs	12 LEDs
Min. cutting length	83.3mm	100mm	166.7mm	166.7mm
Max. length single feed	8M	10M	15M	15M
Max. length double feed	16M	20M	30M	30M
Photo-electric Parameters				
Model	NF1228S-24-072-15W	NF1228S-24-060-12W	NF1228S-24-060-7.2W	NF1228S-24-072-5W
CCT	lm/M	lm/M	lm/M	lm/M
R	/	/	>100lm	>40lm
G	>200lm	>180lm	/	>70lm
B	>35lm	>30lm	/	>13lm
A	/	/	>100lm	>40lm
O	/	/	>80lm	>32lm
P	>160lm	>130lm	/	>55lm
LY	>270lm	>220lm	/	/
2200K	>290lm	>250lm	/	>110lm
2700K	>290lm	>250lm	/	>110lm
3000K	>290lm	>300lm	/	>110lm
3500K	>340lm	>300lm	/	>120lm
4000K	>340lm	>300lm	/	>120lm
5000K	>350lm	>320lm	/	>130lm

Ordering Code

Primary Model	Input Voltage(V)	LED QTY/M	Typical Wattage(W/m)	Color / Light Color	Connector entry type	Connector direction	Cable connector type		
NF1228S	24 DC24V	060 60pcs 072 72pcs	5W 7.2W 12W 15W	2200K 2700K 3000K 3500K 4000K 5000K Red Green Blue Amber Orange Pink Lemon Yellow	2.2K 2.7K 3K 3.5K 4K 5K R G B A O P LY	S D B	Right Left Double	01 Male connector cable 02 Female connector cable 03 Male & female connector cable Blank Bare wire	SM SF SMF Blank

Tunable, RGB, RGBW, DMX version are also available (To be ordered separately)

NEW

Construction

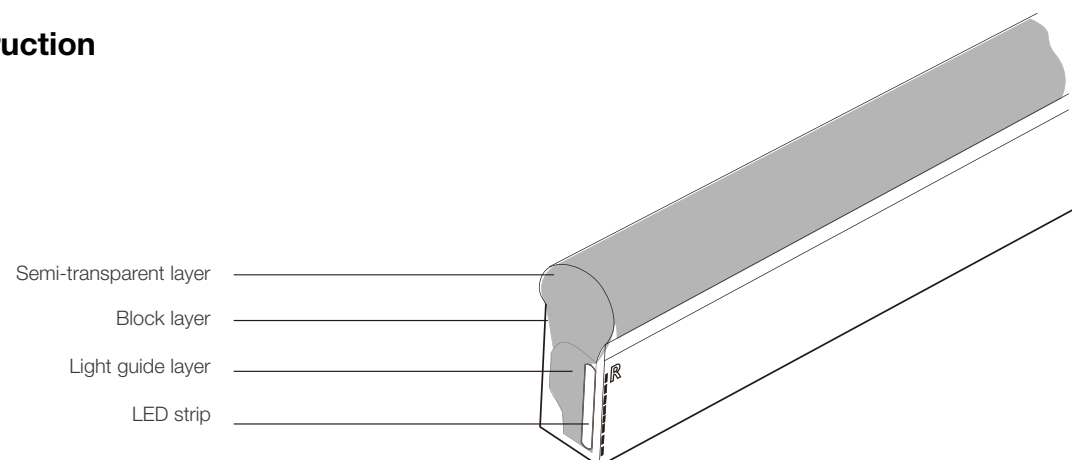

Physical Specification

Light profile

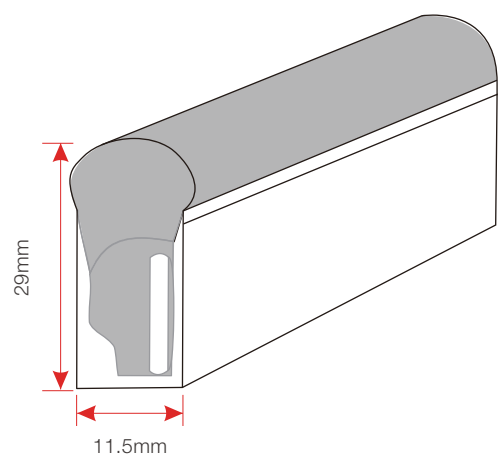

Bending direction

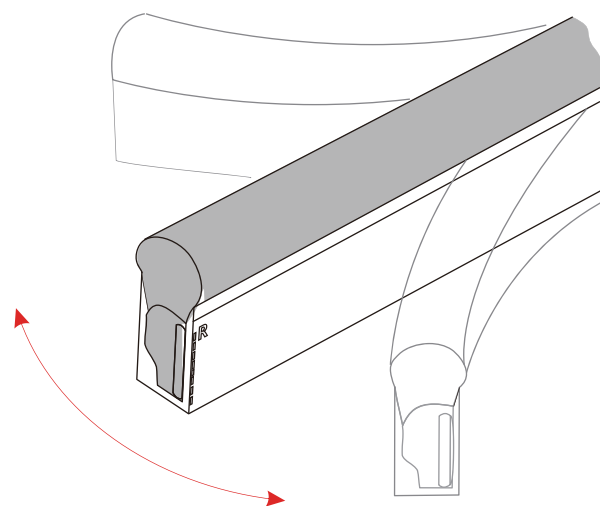

Min. bending diameter

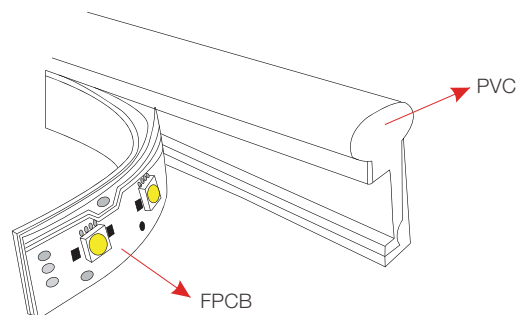
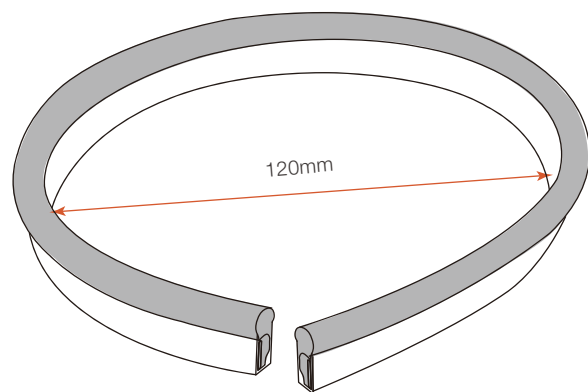

Mould injection connector

(IP68 Factory Assembly only)

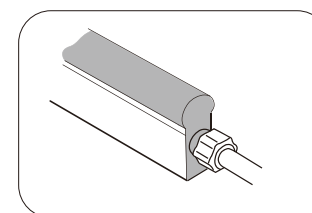

- ① MJ-1228-A-D01
- ② MJ-1228-A-D01SM
- ③ MJ-1228-A-D02
- ④ MJ-1228-A-D02SF
- ⑤ MJ-1228-A-D03
- ⑥ MJ-1228-A-D03SMF

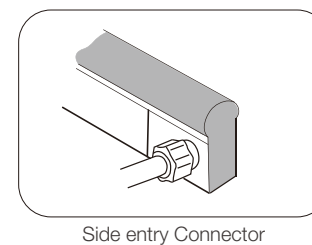
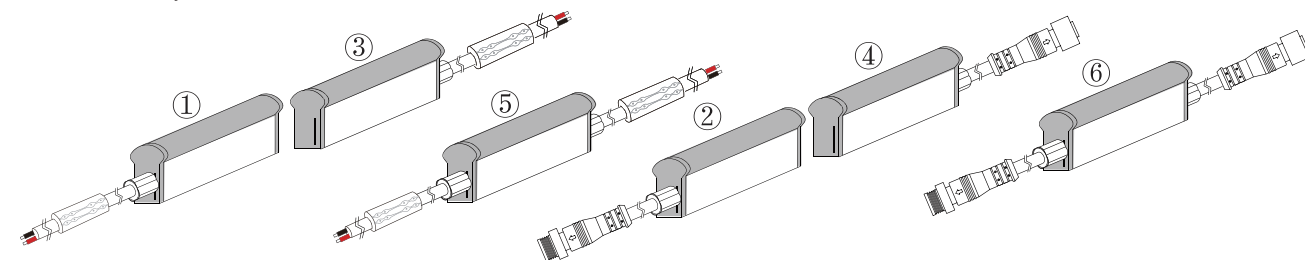
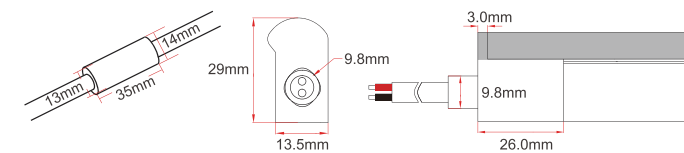

- ① MJ-1228-A-S01
- ② MJ-1228-A-S01SM
- ③ MJ-1228-A-S02
- ④ MJ-1228-A-S02SF
- ⑤ MJ-1228-A-S03
- ⑥ MJ-1228-A-S03SMF

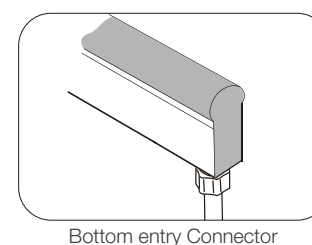
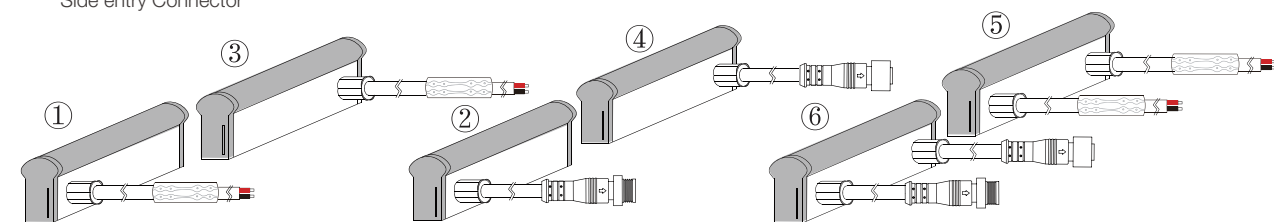
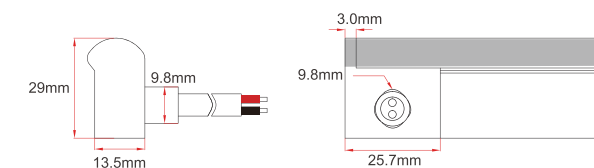

- ① MJ-1228-A-B01-06
- ② MJ-1228-A-B01SM
- ③ MJ-1228-A-B02
- ④ MJ-1228-A-B02SF
- ⑤ MJ-1228-A-B03
- ⑥ MJ-1228-A-B03SMF

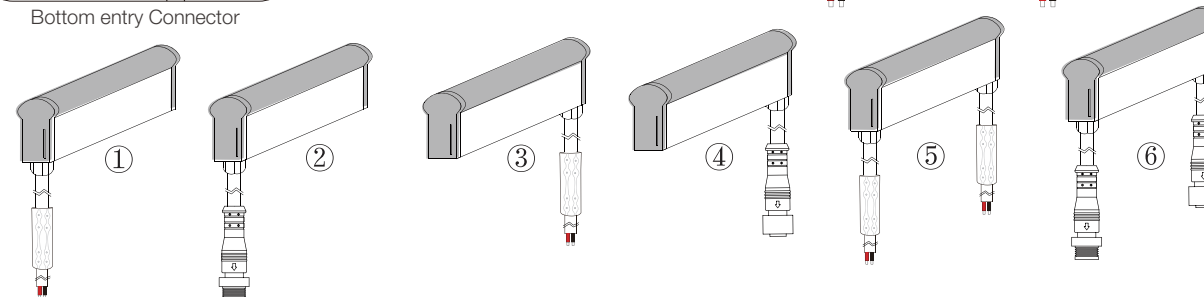
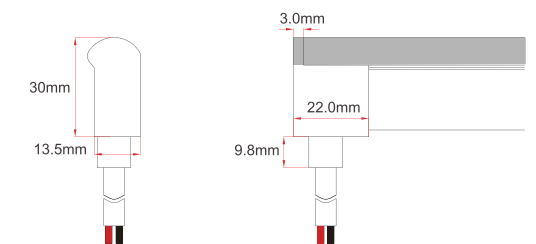

NEW

Mould injection Jumper

(Ip68 Factory Assembly only)

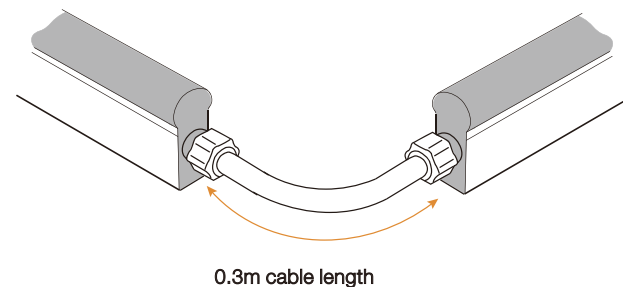

0.3m cable length

DIY snap splice connector
(IP67 Only)

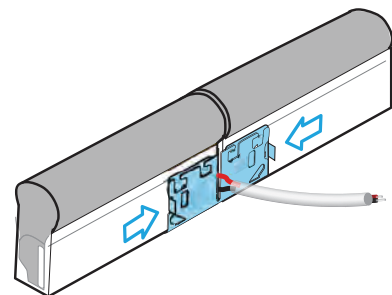

DIY Screw & Snap Connector Kit (IP67 Only)

DIY screw splice connector kit

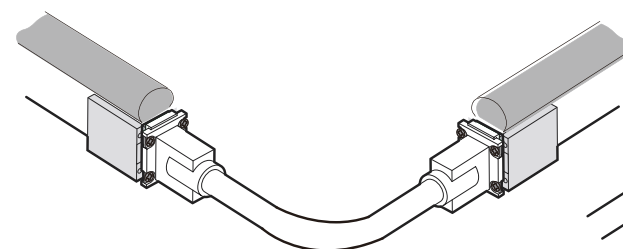

DIY screw connector kit

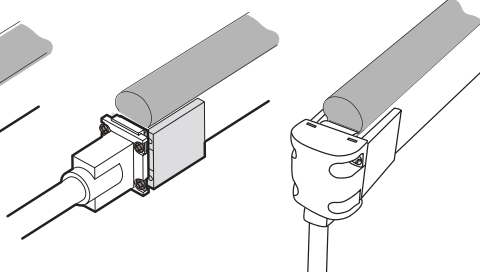

DIY screw front connector

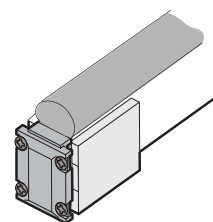

DIY screw end cap

DIY screw splice connector kit

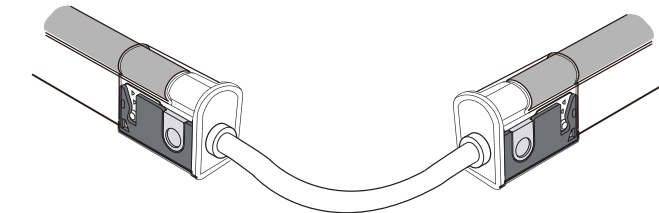

DIY snap connector kit

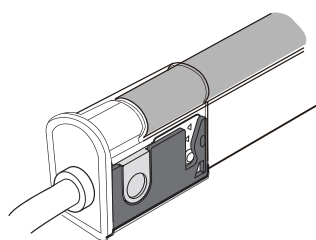

DIY screw front connector

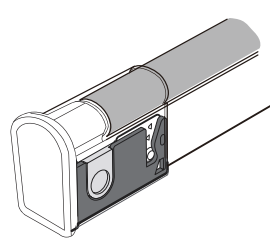

DIY screw end cap

Type

- Middle injection Connector
- DIY snap splice connector
- DIY screw connector kit Jumper
- DIY screw front connector
- DIY screw end cap kit
- DIY snap front connector
- DIY screw end cap kit

Model

- MJ-1228-A-M01-06
- DIY-SC-Middle-1221/1228
- DIY-SC-EXT-1221/1228-D-A
- DIY-SC-FR-1221/1228-D-01-A (Right)
- DIY-SC-FR-1221/1228-D-02-A (Left)
- DIY-SC-FR-1221/1228-B-01-A (Right)
- DIY-SC-FR-1221/1228-B-02-A (Left)
- DIY-SC-END-1221/1228
- DIY-SN-FR-1221/1228-D-01-A (Right)
- DIY-SN-FR-1221/1228-D-02-A (Left)
- DIY-SN-END-1221/1228-01 (Right)
- DIY-SN-END-1221/1228-02 (Left)

Other Accessories

Female & Male Connector

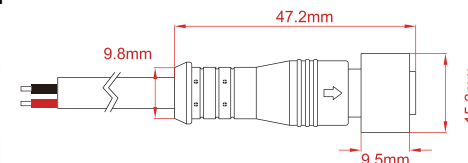

Female connector wire
SYZ-M12-M-2C-075-W

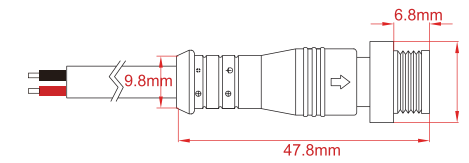

Male connector wire
SYZ-M12-F-2C-075-W

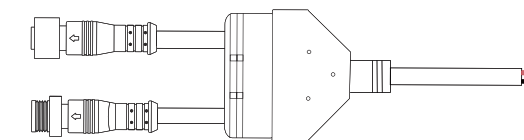
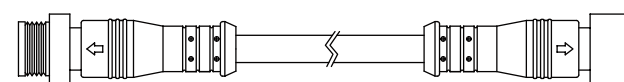

Middle power connector
MID-CNR-A-1T2

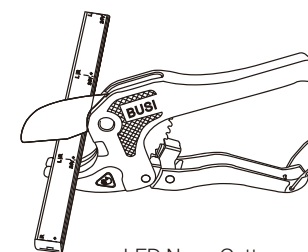

LED Neon Cutter
ACC-TOOL-C1

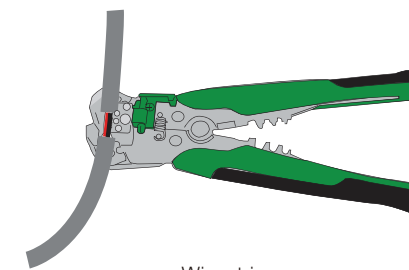

Wire stripper
ACC-TOOL-WS01

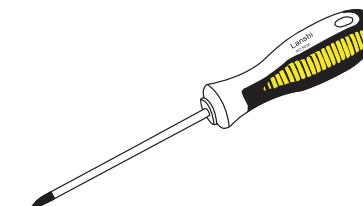

Screwdriver
ACC-TOOL-C2



Mean Well Transformer
Non-waterproof Series

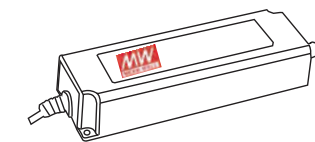

Mean Well Transformer
Waterproof Series



Female & male wire connector
KJ-M12-2P-F/ KJ-M12-2P-M



Silicone Rubber
K-5905

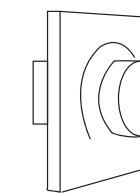

Dimmer



Assistant Tool A
CC-TOOL-C3

NEW

Mounting Profile

Model	Description	Dimension	Drawing
ALC1221/1228S01	Compatibility: NF1221S & NF1228S Length option: 1m,2m,35mm Material: Aluminum alloy Optional color: AS/AB/PW Type: Standard		
ALC1221/1228S02	Use for: NF1221S & NF1228S Length option: 1m,2m,35mm Material: Aluminum alloy Optional color: AS/AB/PW Type: Anti-drop for upside down installation		
ALC1221/1228H01	Use for: NF1221S & NF1228S Length option: 1m,2m,35mm Material: Aluminum alloy Optional color: AS/AB/PW Type: Cable hiding		
ALC1221/1228V01	Use for: NF1221S & NF1228S Length option: 1 m,2m,35mm Material: Aluminum alloy Optional color: AS/AB/PW Type: Vertical installation		
SSC1221/1228FLX	Use for: NF1221S & NF1228S Length option: 10cm,30cm,50cm, 100cm Material: Stainless steel Optional color: Polished Type: Flexible		
SSC1221/1228S01	Use for: NF1221S & NF1228S Length option: 5cm Material: Stainless steel Optional color: Natural color Type: 316 stainless steel		

Dimming system Connection

0-10V dimming system

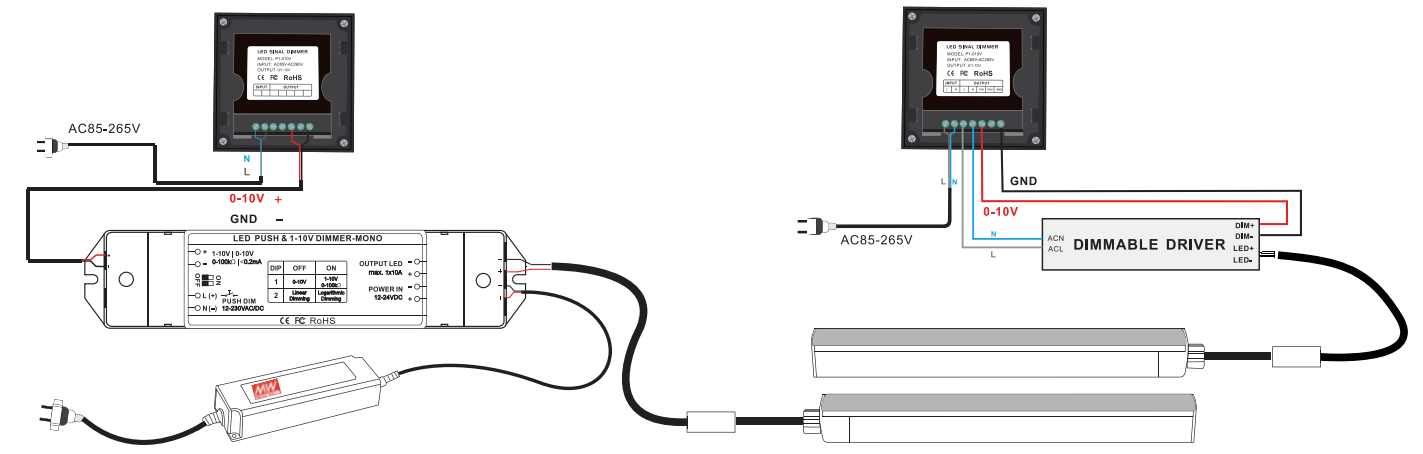

DMX512 dimming system

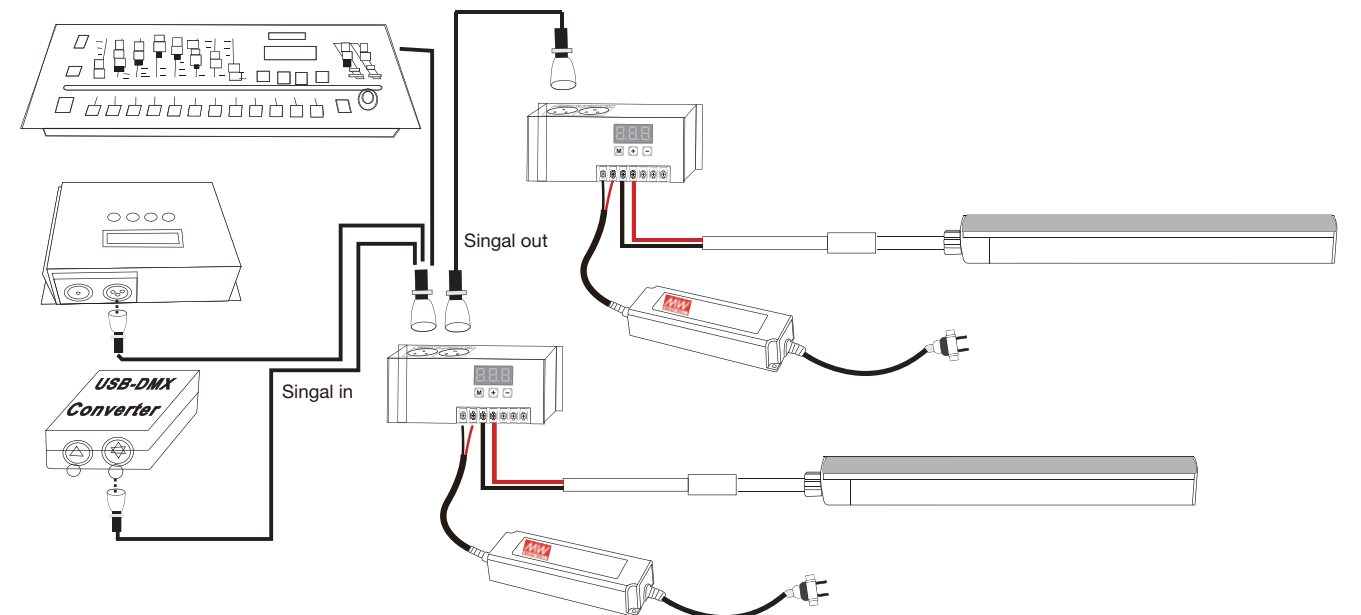

DALI dimming system

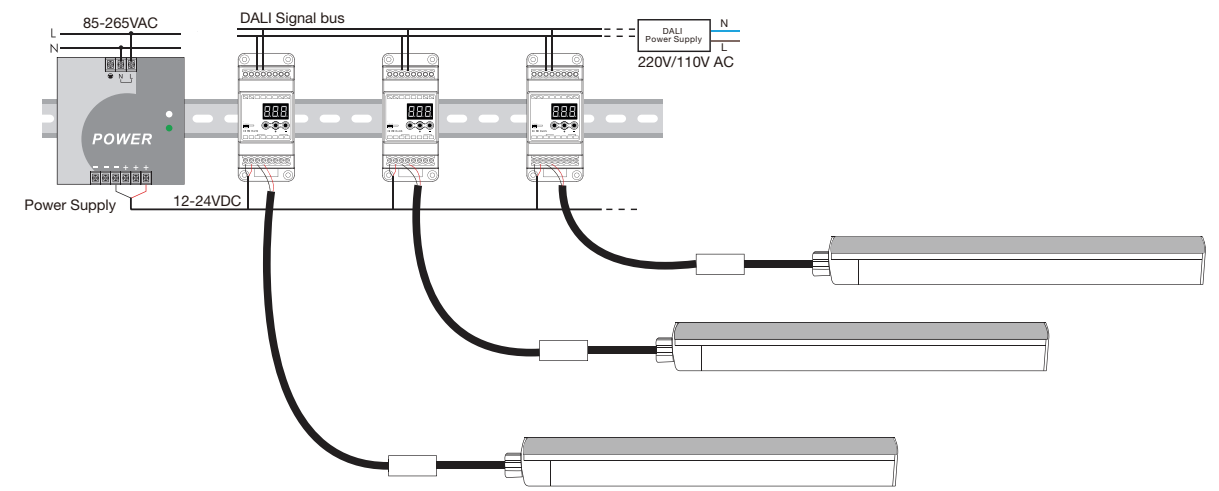

Control NEKO luminaires via CASAMBI

CASAMBI is a versatile Bluetooth-based lighting control solution for commercial, residential, hospitality, office, and retail spaces. Supporting NEKO luminaires, it offers seamless, smart control over lighting networks through an intuitive app, making it ideal for various applications.

Connect NEKO luminaires onto CASAMBI

Here below are the options.

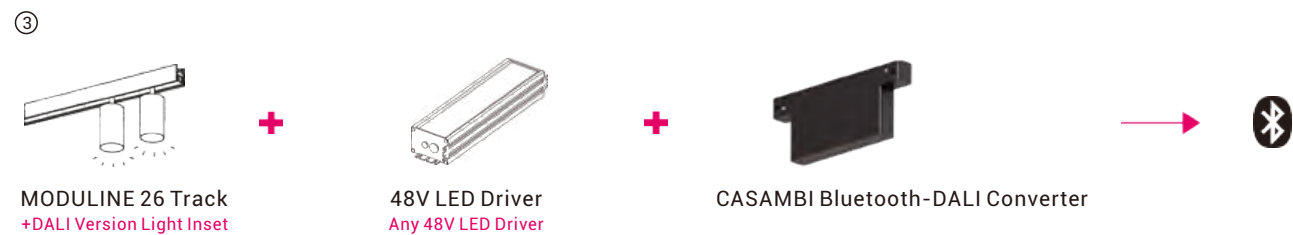
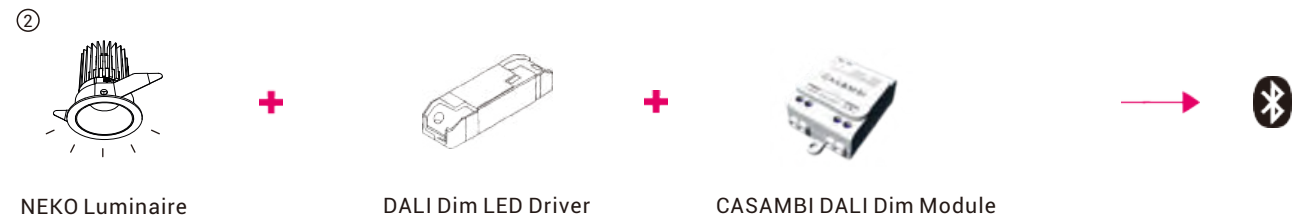
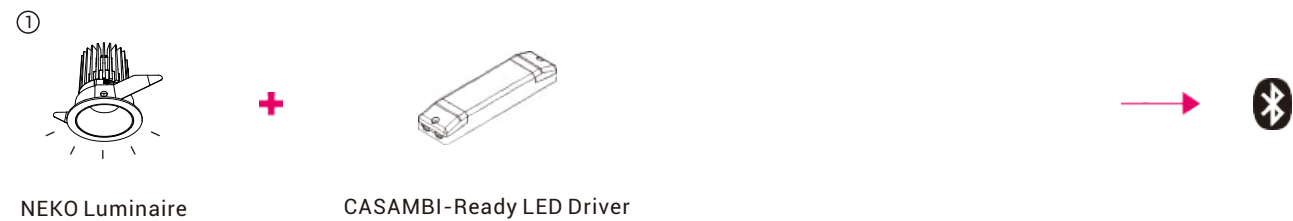

CASAMBI Wireless Controls

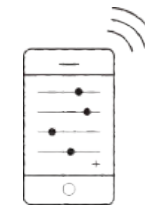

CASAMBI App



CASAMBI Switch

① DALI Dim, CASAMBI-Ready LED Driver

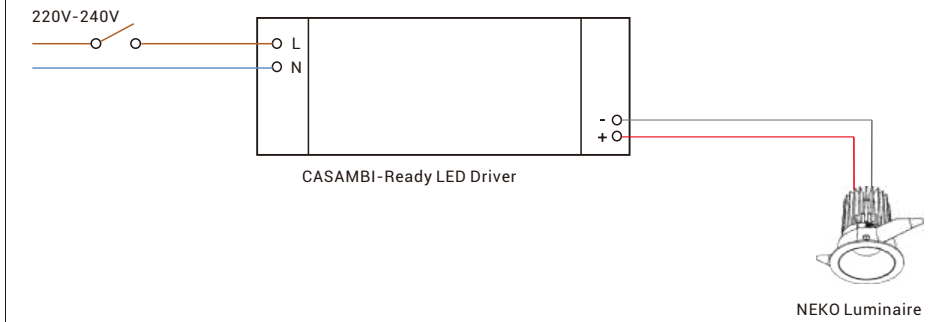

② DALI Dim, CASAMBI DALI Dim Module

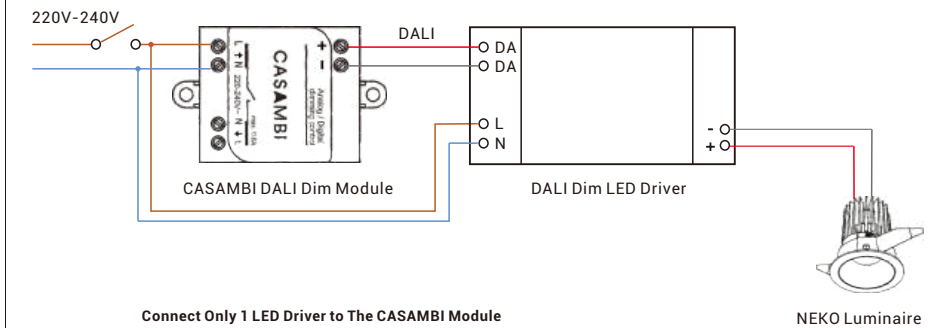

③ CASAMBI DALI Dim Control for NEKO Moduline 26 System

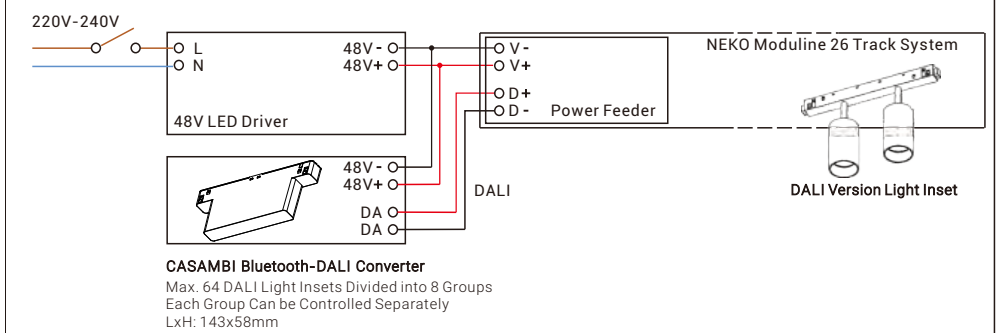

Lighting Controls Wiring Diagrams

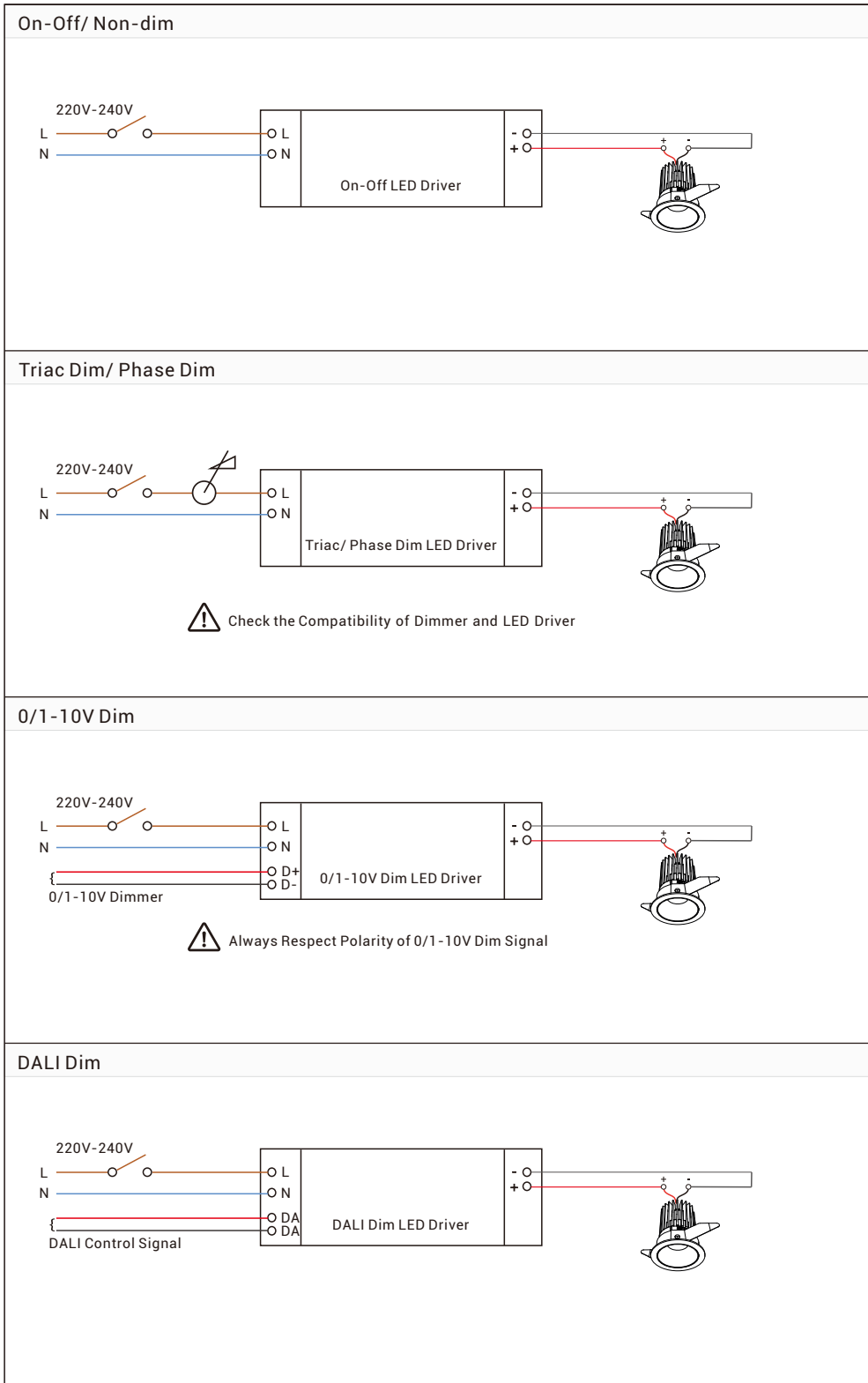

Wiring Diagrams of Moduline 26 Track System

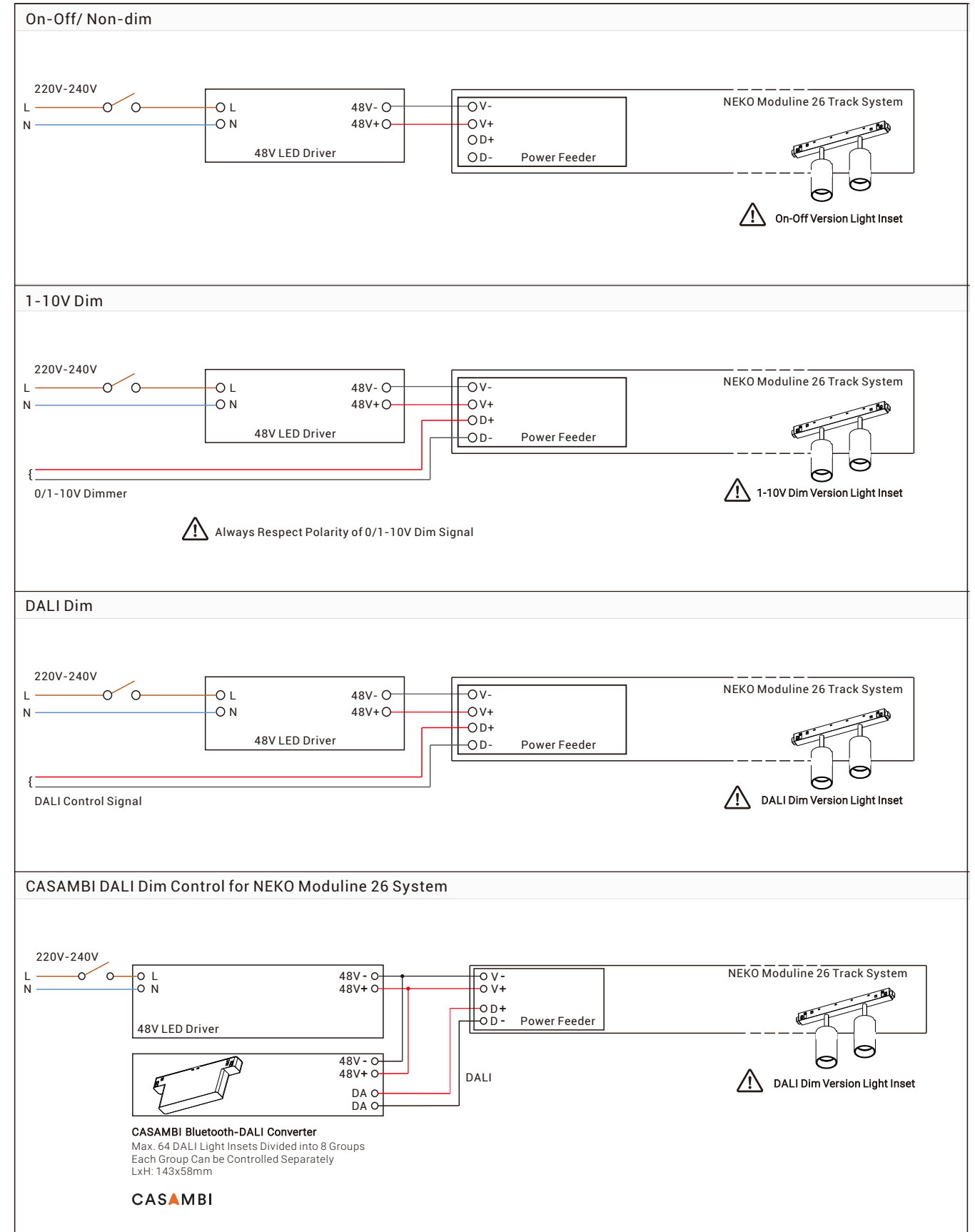

OUTDOOR

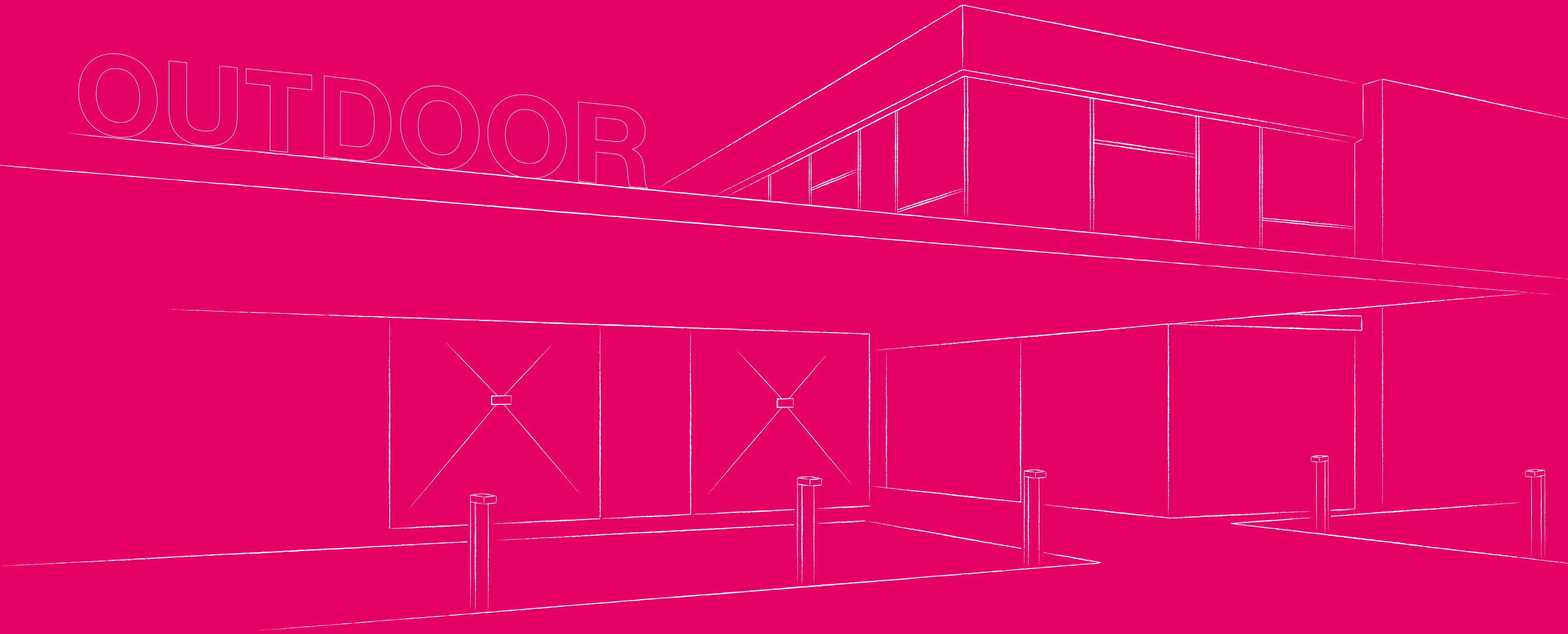

INDEX

SEAPOINT Series



SEAPOINT
■ 581-582

LAKEPOINT Series



LAKEPOINT Fixed
■ 583-584

LAKEPOINT Adjustable
■ 585-586

CARMEL Series

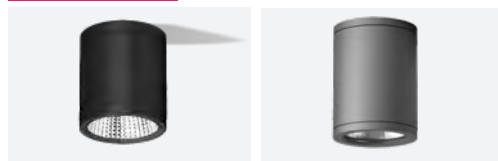

SKYSURFER SSRC
■ 587-588

CARMEL Round
■ 585-590

CLIFTON Series



CLIFTON
■ 591-592

RIVA Series

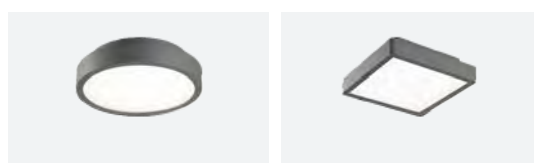

RIVA Round
■ 593-594

RIVA Square
■ 595-596

CAMPSBAY Series

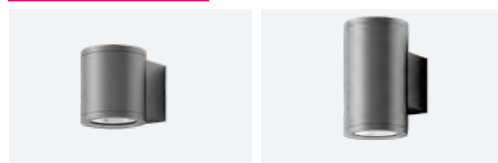

CAMPSBAY Single
■ 597-598

CAMPSBAY Double

LAGOON Series



LAGOON
■ 599-600

CRUZ D Series



CRUZ D
■ 601-602

CAPRI Series



CAPRI
■ 603-604

BAY Series



BAY
■ 605-606

NICE Series

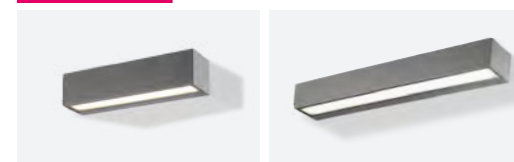

NICE 250S & NICE 250D
■ 607-608

NICE 500S & NICE 500D
■ 609-610

St.Tropez Series



St.Tropez
■ 611-612

Capetown-Recessed Series

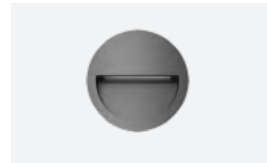

Capetown Round-Recessed
■ 613-614



Capetown Square-Recessed

Capetown-Surface Series

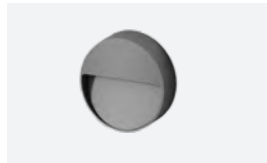

Capetown Round-Surface
■ 615-616



Capetown Square-Surface

POSEIDON Series

! NEW

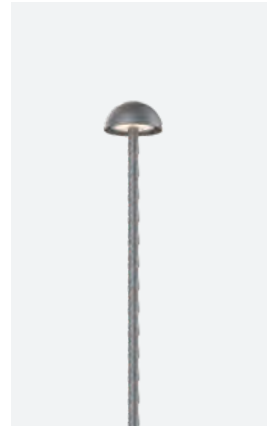

POSEIDON S100A
■ 617-620



POSEIDON S100B

CALIFORNIA Series



CALIFORNIA 12
■ 621-622

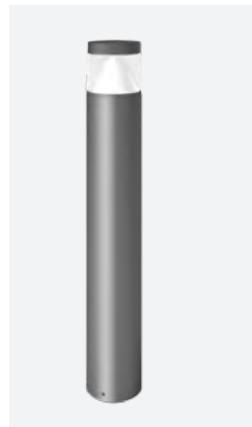

CALIFORNIA 16

DURBAN Series



DURBAN
■ 623-624

POSITANO Series

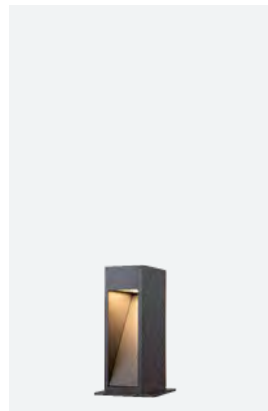

POSITANO 300
■ 625-626



POSITANO 600

PORTOFINO Series



PORTOFINO S
■ 627-628



PORTOFINO L



PORTOFINO Adjustable

AFTER7 Series



AFTER7 Mini
■ 631



AFTER7 Maxi
■ 632

NEPTUNE Series

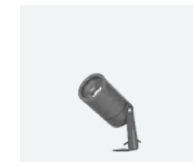

NEPTUNE XSU CV
■ 635

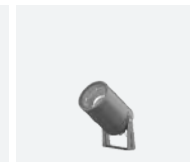

NEPTUNE SU CV
■ 636



NEPTUNE MU CV
■ 637



NEPTUNE LU CV
■ 638



NEPTUNE SR CV
NEPTUNE SR HV
■ 640



NEPTUNE MR CV
NEPTUNE MR HV
■ 641



NEPTUNE LR CV
NEPTUNE LR HV
■ 642

TERARACE Series

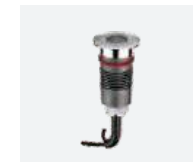

TERARACE Micro
■ 643



TERARACE Nano
■ 644



TERARACE Mini
■ 647



TERARACE Maxi
■ 648

EXTERIOR LIGHTING

Project: Hotel Sorrisniva, Norway



EXTERIOR LIGHTING

Project: otel Atlantis, Crech Republic



SEAPINT – Exterior LED Downlight

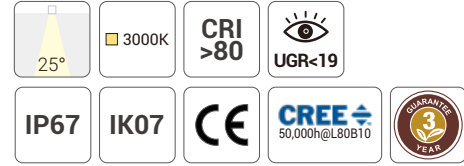

Quick Info

- Ceiling Cut-out: Ø100mm
- CREE LED: 6W, CRI>90, 3000K
- Beam Angle: 25°
- Lumen Output: Up to 450lm System Luminous Flux
- IP Class: IP67
- Body: Aluminum; Color: Black
- LED Driver: With internal Non-Dimmable LED driver

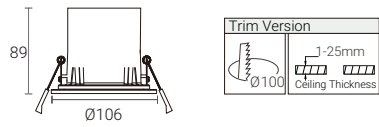

Light Distribution

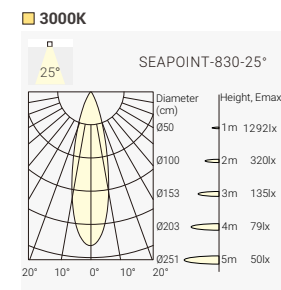

Order Info

LED Power	System Power	Input	CRI	CCT	Beam	System Output	Model	Code
5W	6W	220-240V	90	3000K	25°	450lm	SEAPINT-830-25°	SEAP-8302506F-BN

Remark: With internal Non-Dimmable LED driver



LAKEPOINT Fixed – Exterior LED Downlight



Quick Info

- Ceiling Cut-out: Ø90mm, 3000K
- CREE LED: 6W, CRI>80
- Beam Angle: 30°
- Lumen Output: Up to 500lm System Luminous Flux
- IP Class: IP65
- Body: Aluminum; Color: White/ Black
- LED Driver: With Non-Dimmable LED driver

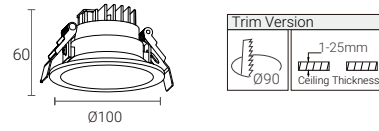

Light Distribution

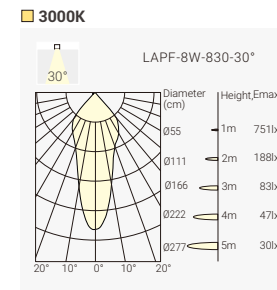

Finish



Order Info

LED Power	System Power	Input	CRI	CCT	Beam	System Output	Model	Code
6W	8W	220-240VAC	80	3000K	30°	500lm	LAKEPOINT F-830-30°	LAPF-8303008F-WW LAPF-8303008F-BB

Remark: With internal Non-Dimmable LED driver



LAKEPOINT Adjustable – Exterior LED Downlight

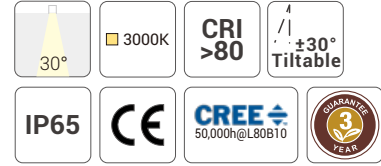

Quick Info

- Ceiling Cut-out: Ø100mm
- CREE LED: 6W, CRI>80, 3000K
- Beam Angle: 30°
- Lumen Output: Up to 500lm System Luminous Flux
- IP Class: IP65
- Body: Aluminum; Color: White/ Black
- LED Driver: With Non-Dimmable LED driver

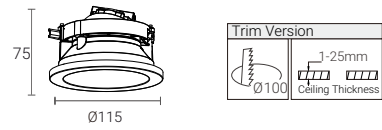

Light Distribution

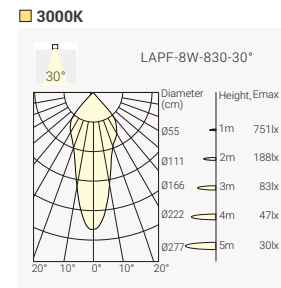

Finish



Order Info

LED Power	System Power	Input	CRI	CCT	Beam	System Output	Model	Code
6W	8W	220-240VAC	80	3000K	30°	500lm	LAKEPOINT A-830-30°	LAPA-8303008F-WW LAPA-8303008F-BB

Remark: With internal Non-Dimmable LED driver

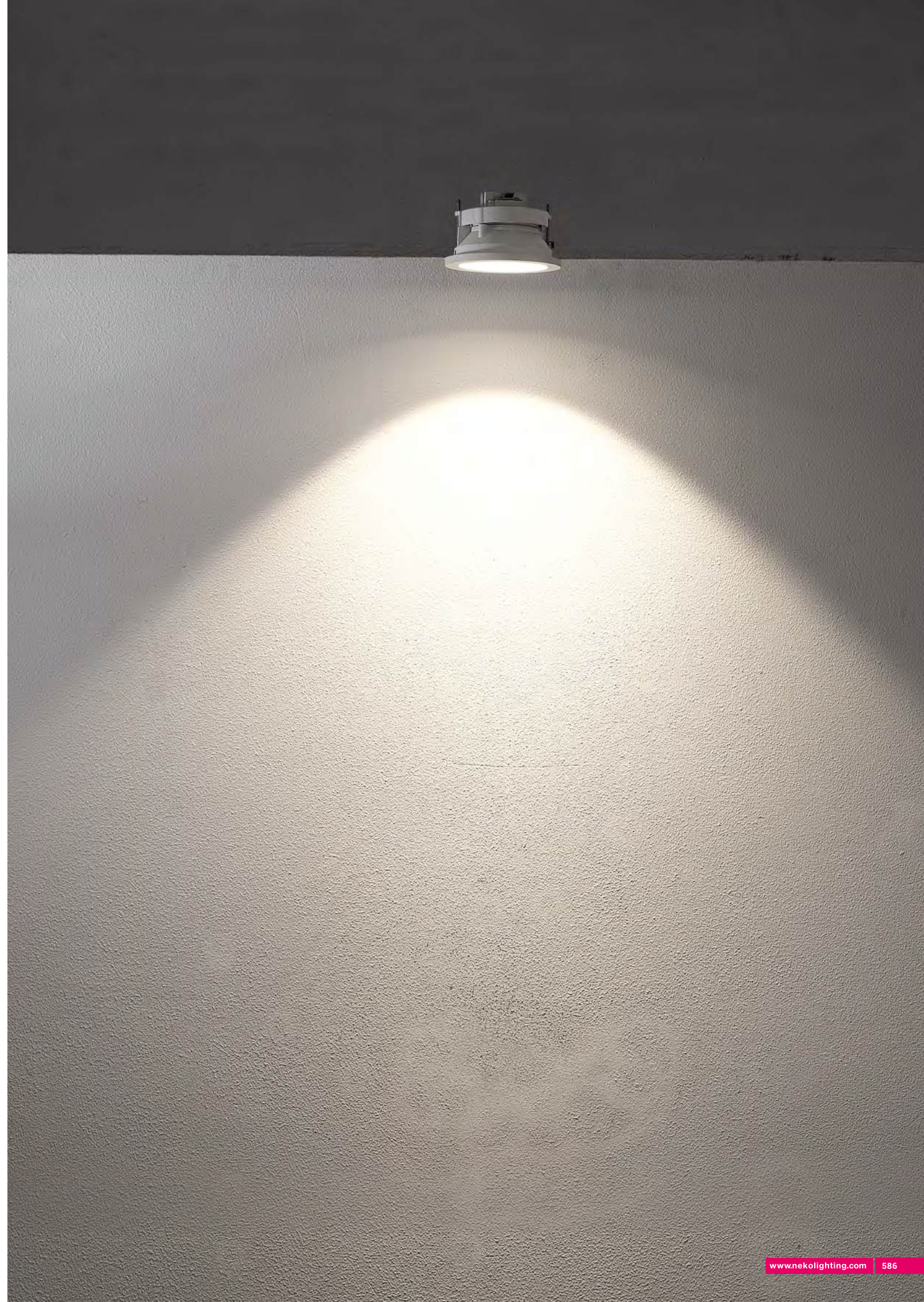

SKYSURFER SSRC – IP65 LED Ceiling Light

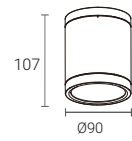

Quick Info

- CITIZEN LED: 8W, CRI>90, 3000K
- Beam Angle: 36°
- Lumen Output: Up to 850lm System Luminous Flux
- IP Class: IP65
- Body: Aluminum; Color: Black
- LED Driver: With internal Non-Dimmable LED driver

Light Distribution

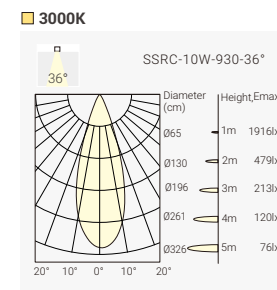

Order Info

LED Power	System Power	Input	CRI	CCT	Beam	System Output	Model	Code
8W	10W	220-240VAC	90	3000K	36°	850lm	SSRC-10W	SSRC-9303610F-BN

Remark: With internal Non-Dimmable LED driver



CARMEL – LED Ceiling Light

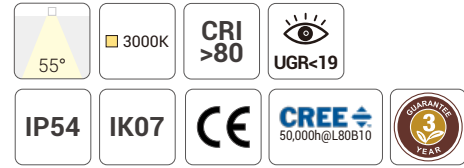
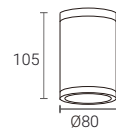

Quick Info

- CREE LED: 5W, CRI>80, 3000K
- Beam Angle: 55°
- Lumen Output: Up to 500lm System Luminous Flux
- IP Class: IP54
- Body: Aluminum; Color: Dark-Grey
- LED Driver: With internal Non-Dimmable LED driver

Light Distribution

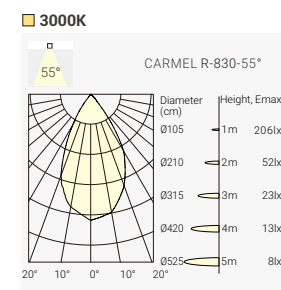

Order Info

LED Power	System Power	Input	CRI	CCT	Beam	System Output	Model	Code
5W	6W	220-240VAC	80	3000K	55°	500lm	CARMEL R-830-55°	CARR-8305506F-DN

Remark: With internal Non-Dimmable LED driver



CLIFTON – LED Ceiling Light

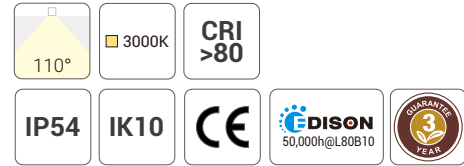

Quick Info

- EDISON LED: 22W, CRI>80, 3000K
- Beam Angle: 110°
- Lumen Output: Up to 2350lm System Luminous Flux
- IP Class: IP54
- Body: Aluminum; Color: Dark-Grey
- LED Driver: With internal Non-Dimmable LED driver

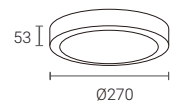

Light Distribution

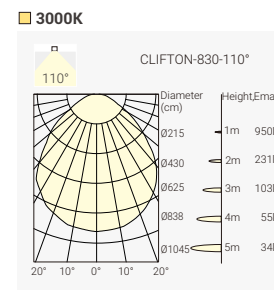

Order Info

LED Power	System Power	Input	CRI	CCT	Beam	System Output	Model	Code
22W	25W	220-240VAC	80	3000K	110°	2350lm	RIVA Round-830-110°	CLIF-830A125F-DN

Remark: With internal Non-Dimmable LED driver



RIVA ROUND – LED Ceiling Light

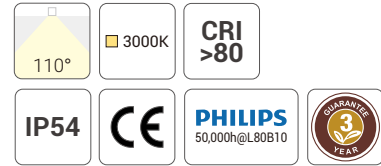
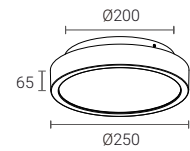

Quick Info

- PHILIPS LED: 12W, CRI>80, 3000K
- Beam Angle: 110°
- Lumen Output: Up to 1150lm System Luminous Flux
- IP Class: IP54
- Body: Aluminum; Color: Dark-Grey
- LED Driver: With internal Non-Dimmable LED driver

Light Distribution

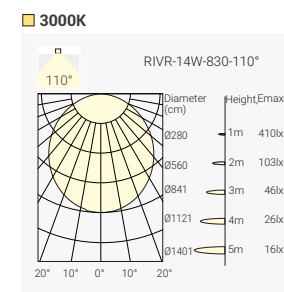

Order Info

LED Power	System Power	Input	CRI	CCT	Beam	System Output	Model	Code
12W	14W	220-240VAC	80	3000K	110°	1150lm	RIVR-14W-830-110°	RIVR-830A114F-DN

Remark: With internal Non-Dimmable LED driver



RIVA SQUIRE – LED Ceiling Light

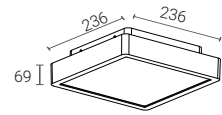

Quick Info

- PHILIPS LED: 12W, CRI>80, 3000K
- Beam Angle: 110°
- Lumen Output: Up to 1150lm System Luminous Flux
- IP Class: IP54
- Body: Aluminum; Color: Dark-Grey
- LED Driver: With internal Non-Dimmable LED driver

Light Distribution

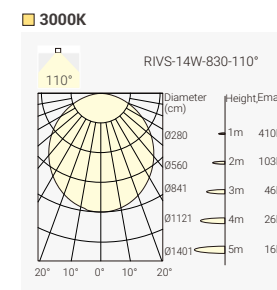

Order Info

LED Power	System Power	Input	CRI	CCT	Beam	System Output	Model	Code
12W	14W	220-240VAC	80	3000K	110°	1150lm	RIVA Square-830-110°	RIVS-830A114F-DN

Remark: With internal Non-Dimmable LED driver

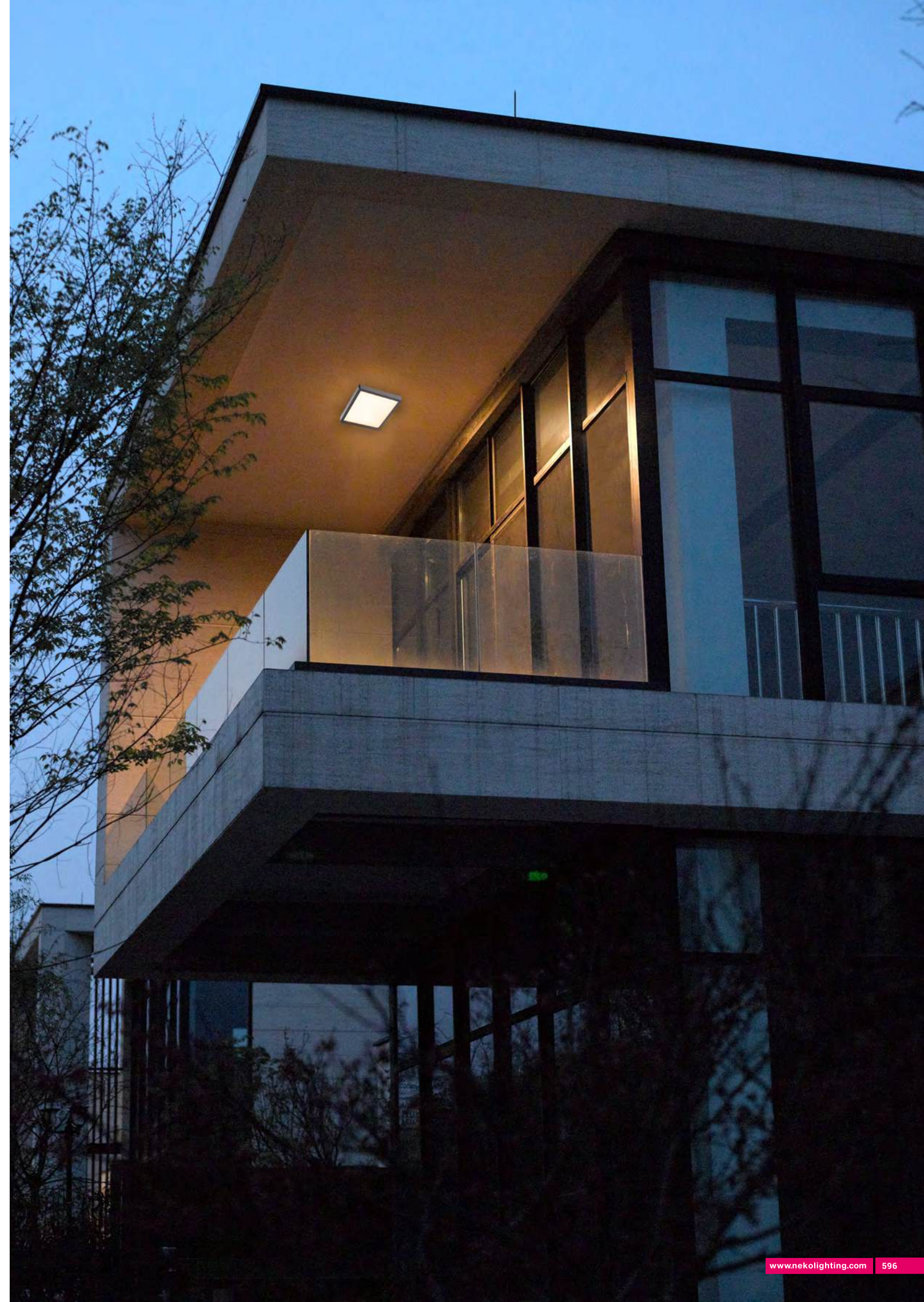



CAMPSBAY Single

CAMPSBAY Double

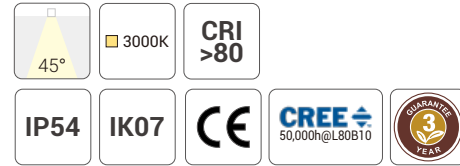
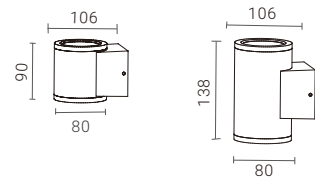

Quick Info

- CREE LED: 5W, 10W, CRI>80, 3000K
- CCT: 3000K Available as Standard
- Beam Angle: 45°
- Lumen Output: Up to 500lm/ 1000lm System Luminous Flux
- IP Class: IP54
- Body: Aluminum; Color: Dark-Grey
- LED Driver: With internal Non-Dimmable LED driver

Light Distribution

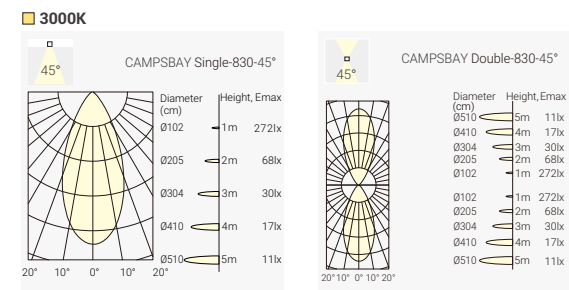

Order Info

LED Power	System Power	Input	CRI	CCT	Beam	System Output	Model	Code
5W	6W	220-240VAC	80	3000K	45°	500lm	CAMPSBAY Single-830-45°	CAMS-8304506F-DN
10W	12W	220-240VAC	80	3000K	45°145°4	1000lm	CAMPSBAY Double-830-45°	CAMD-8304512F-DN

Remark: With internal Non-Dimmable LED driver



LAGOON – LED Wall Light

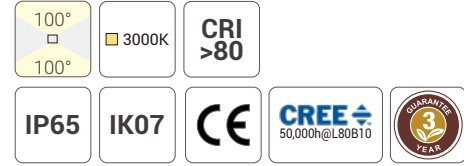

Quick Info

- CREE LED: 9W, CRI>80, 3000K
- Beam Angle: 100°
- Lumen Output: Up to 950lm System Luminous Flux
- IP Class: IP65
- Body: Aluminum; Color: Dark-Grey
- LED Driver: With internal Non-Dimmable LED driver

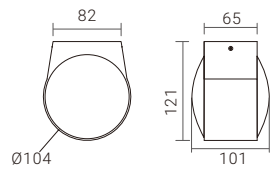

Light Distribution

3000K

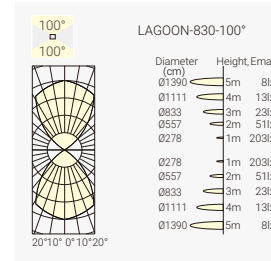

Order Info

LED Power	System Power	Input	CRI	CCT	Beam	System Output	Model	Code
9W	11W	220-240VAC	80	3000K	100° 100°*	950lm	LAGOON-830-110°	LAG-830A111F-DN

Remark: With internal Non-Dimmable LED driver



CRUZ D – LED Wall Light

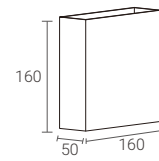

120°
120°
3000K
CRI >80
IP65
IK07
OSRAM
50,000h@L80B10
3 YEAR WARRANTY

Quick Info

- OSRAM LED: 12W, CRI>80, 3000K
- Beam Angle: 120°
- Lumen Output: Up to 1400lm System Luminous Flux
- IP Class: IP65
- Body: Aluminum; Color: Dark-Grey
- LED Driver: With internal Non-Dimmable LED driver

Light Distribution

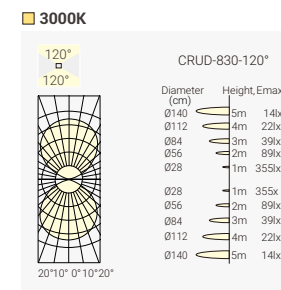

Order Info

LED Power	System Power	Input	CRI	CCT	Beam	System Output	Model	Code
12W	14W	220-240VAC	80	3000K	120° 120°1	1400lm	CRUD-830-120°	CRUD-830A214F-DN

Remark: With internal Non-Dimmable LED driver



CAPRI – LED Wall Light

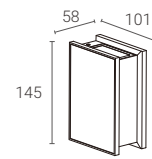
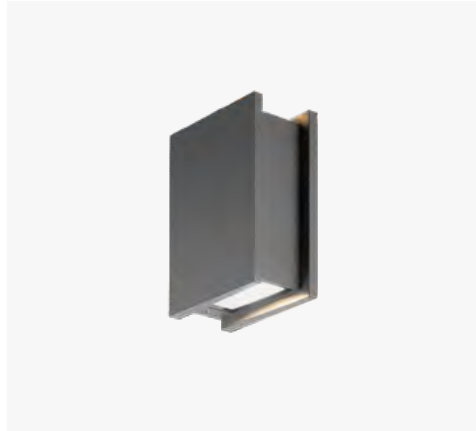

100°
100°
3000K
CRI >80
IP65
IK07
CREE
50,000h@L80B10
3 YEAR WARRANTY

Quick Info

- CREE LED: 14W, CRI>80, 3000K
- Beam Angle: 100°
- Lumen Output: Up to 1300lm System Luminous Flux
- IP Class: IP65
- Body: Aluminum; Color: Dark-Grey
- LED Driver: With internal Non-Dimmable LED driver

Light Distribution

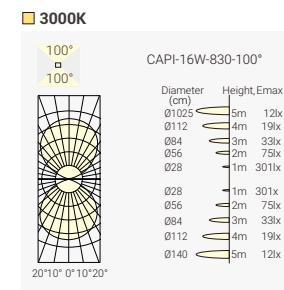

Order Info

LED Power	System Power	Input	CRI	CCT	Beam	System Output	Model	Code
14W	16W	220-240VAC	80	3000K	100° 100°	1300lm	CAPRI-830-100°	CAPI-830A016F-DN

Remark: With internal Non-Dimmable LED driver



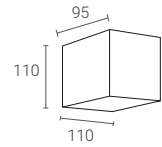

Quick Info

- CREE LED: 5W, CRI>80, 3000K
- Beam Angle: 90°
- Lumen Output: Up to 430lm System Luminous Flux
- IP Class: IP65
- Body: Aluminum; Color: Dark-Grey
- LED Driver: With internal Non-Dimmable LED driver

Light Distribution

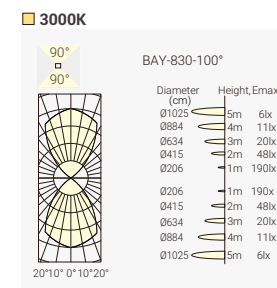

Order Info

LED Power	System Power	Input	CRI	CCT	Beam	System Output	Model	Code
5W	6W	220-240VAC	80	3000K	90° x 90° t	430lm	BAY-830-90°	BAY-8309006F-DN

Remark: With internal Non-Dimmable LED driver



NICE 250 – LED Wall Light

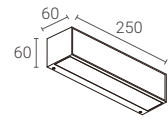

Quick Info

- PHILIPS LED: 5W,12W, CRI>80, 3000K
- Beam Angle: 110°
- Lumen Output: Up to 650lm/ 1300lm System Luminous Flux
- IP Class: IP65
- Body: Aluminum; Color: Dark-Grey
- LED Driver: With internal Non-Dimmable LED driver

Light Distribution

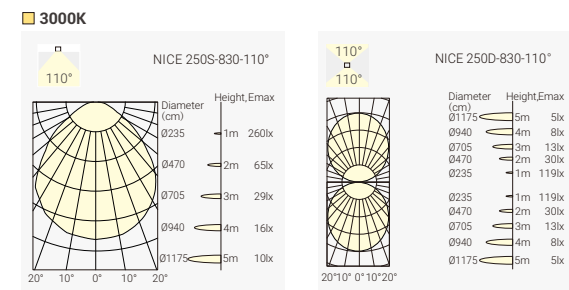

Order Info

LED Power	System Power	Input	CRI	CCT	Beam	System Output	Model	Code
5W	7W	220-240VAC	80	3000K	110°	650lm	NICE 250S-830-110°	N25S-830A107F-DN
12W	14W	220-240VAC	80	3000K	110°	1300lm	NICE 250D-830-110°	N25D-830A114F-DN

Remark: With internal Non-Dimmable LED driver



NICE 500 – LED Wall Light

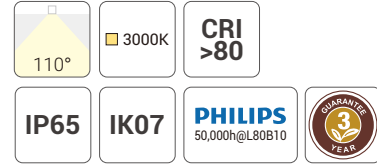
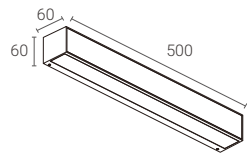

Quick Info

- PHILIPS LED: 12W, 18W, CRI>80, 3000K
- Beam Angle: 110°
- Lumen Output: Up to 1300lm/ 1800lm System Luminous Flux
- IP Class: IP65
- Body: Aluminum; Color: Dark-Grey
- LED Driver: With internal Non-Dimmable LED driver

Light Distribution

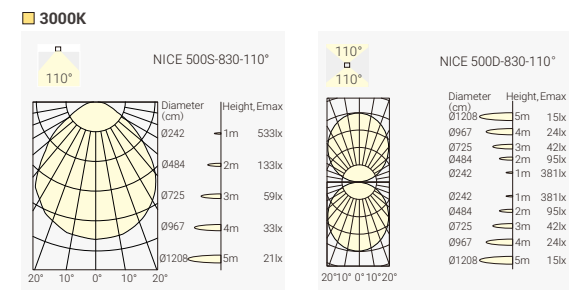

Order Info

LED Power	System Power	Input	CRI	CCT	Beam	System Output	Model	Code
12W	14W	220-240VAC	80	3000K	110°	1300lm	NICE500S-830-110°	N50S-830A114F-DN
18W	20W	220-240VAC	80	3000K	110°/110°*	1800lm	NICE500D-830-110°	N50D-830A120F-DN

Remark: With internal Non-Dimmable LED driver



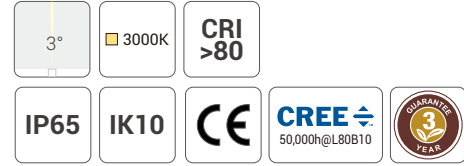

Quick Info

- EDISON LED: 4W, CRI>80, 3000K
- Beam Angle: 3°
- Lumen Output: Up to 300lm System Luminous Flux
- IP Class: IP65
- Body: Aluminum; Color: Dark-Grey
- LED Driver: With internal Non-Dimmable LED driver

Light Distribution

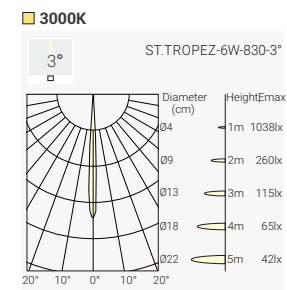

Order Info

LED Power	System Power	Input	CRI	CCT	Beam	System Output	Model	Code
4W	6W	220-240VAC	80	3000K	3°	300lm	St.Tropez-830-3°	STTZ-8300306F-DN

Remark: With internal Non-Dimmable LED driver

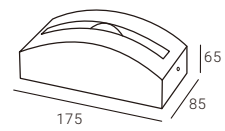

Ceiling / windows frame mounted light
Ideally lighting up the frame of doors, windows, corridors, etc
With its self-balancing system making the un-even surface a proper lighting effect

CAPETOWN – Recessed LED Step Light

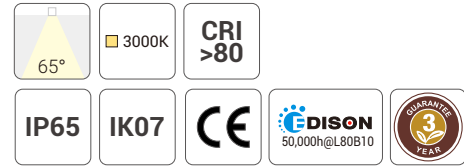
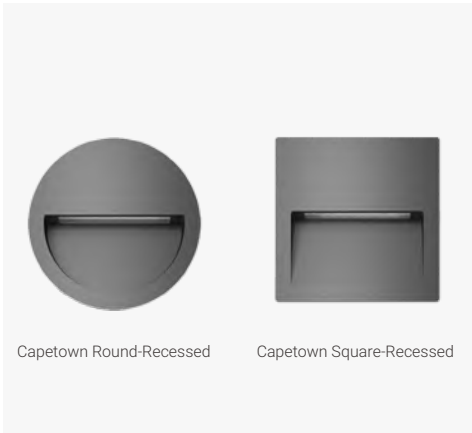

Quick Info

- EDISON LED: 3W, CRI>80, 3000K
- Beam Angle: 65°
- Lumen Output: Up to 155lm/ 165lm System Luminous Flux
- IP Class: IP65
- Body: Aluminum; Color: Dark-Grey
- LED Driver: With internal Non-Dimmable LED driver

Light Distribution

3000K

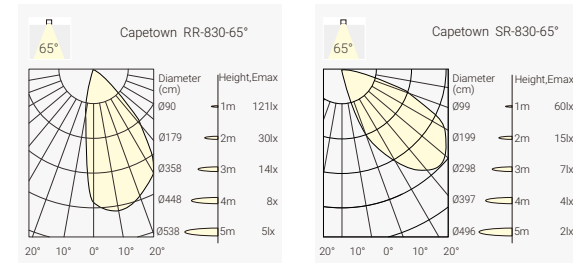

Order Info

LED Power	System Power	Input	Cutout	CRI	CCT	Beam	System Output	Model	Code
3W	4.5W	220-240VAC	Ø110*55	80	3000K	65°	155lm	Capetown RR-830-65°	CTRR-8306505F-DN
3W	4.5W	220-240VAC	110*110*55	80	3000K	65°	165lm	Capetown SR-830-65°	CTSR-8306505F-DN

Remark: With internal Non-Dimmable LED driver



CAPETOWN – Surface LED Step Light

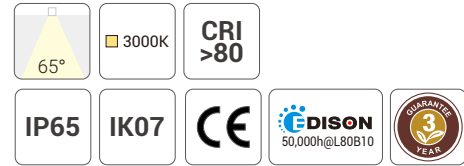
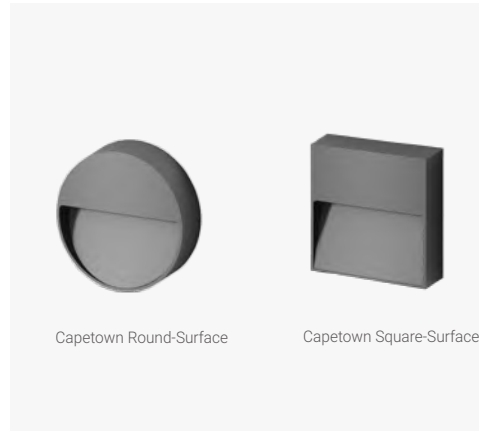

Quick Info

- EDISON LED: 3W, CRI>80, 3000K
- Beam Angle: 65°
- Lumen Output: Up to 150lm/ 170lm System Luminous Flux
- IP Class: IP65
- Body: Aluminum; Color: Dark-Grey
- LED Driver: With internal Non-Dimmable LED driver

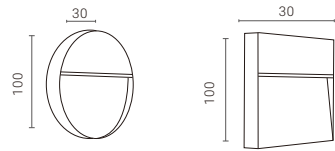

Light Distribution

3000K

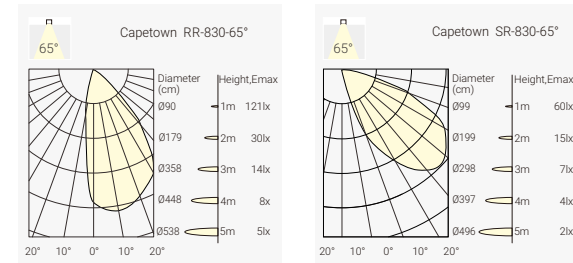

Order Info

LED Power	System Power	Input	CRI	CCT	Beam	System Output	Model	Code
3W	4.5W	220-240VAC	80	3000K	65°	150lm	Capetown RS-830-65°	CTRS-8306505F-DN
3W	4.5W	220-240VAC	80	3000K	65°	170lm	Capetown SS-830-65°	CTSS-8306505F-DN

Remark: With internal Non-Dimmable LED driver

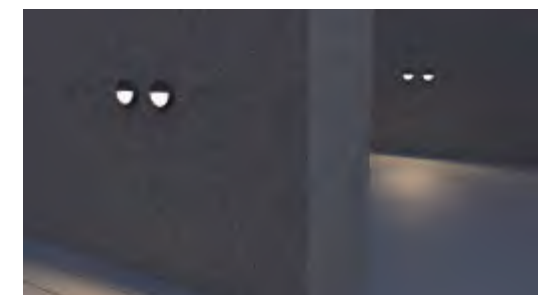

! NEW



Features

- Modular designed pathway light with IP66 waterproof rating, perfect for outdoor use
- Twist & Lock covers are interchangeable, styles can be custom made
- Press button for CCT changeable, warm 2700K(2200K Optional) or cozy 3000K
- Extension poles are available with shrubbery growing
- Multiple installation accessories; Pole, Spike or base mounting
- Triple layer coating, ensuring over 1000hours of salt mist test, suitable for seaside installations
- Wider light distribution 130° achieved by advanced lens design
- Invisible screws for esthetic appeal

- The top cover is designed to prevent loss, requiring a downward press to unlock, similar to the safety cap mechanism.

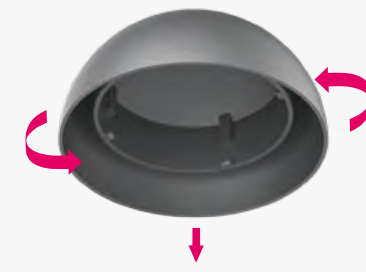

- Interchangeable Covers

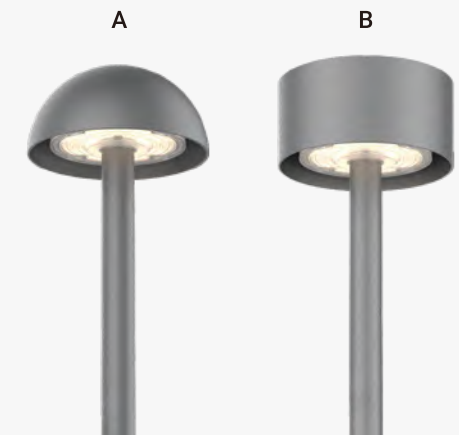

- Press Button for 2CCT Changeable



2700K



3000K

- 2700K-3000K Changeable



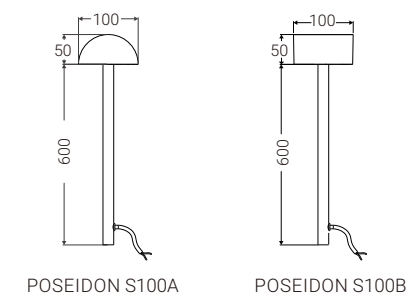
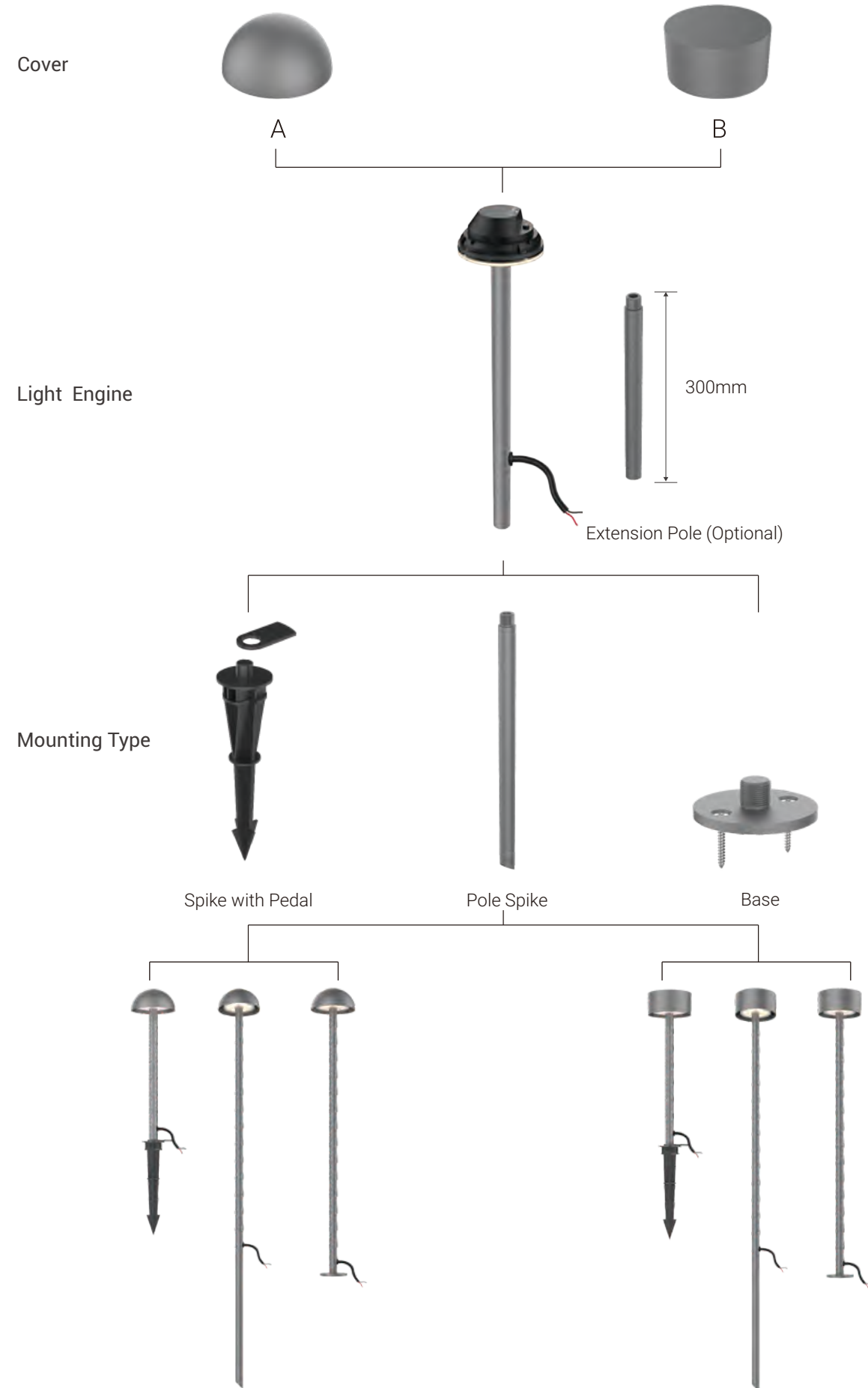

360°
2700K
3000K
CRI >80
IP66
IK07
CE
OSRAM
50,000h@L80B10
5 YEARS
GUARANTEE

Quick Info

- OSRAM LED: 4W, 5W, CRI>80, 2700K(2200K Optional)-3000K Changeable
- Beam Angle: Light Emission 360°
- Lumen Output: Up to 370m/ 485lm System Luminous Flux
- IP Class: IP66
- Body: Aluminum; Color: Dark-Grey
- 24VDC Version: 24VDC Remote On-Off LED Driver
- LED Driver Integrated Version: On-Off, 220~240VAC Input

Light Distribution

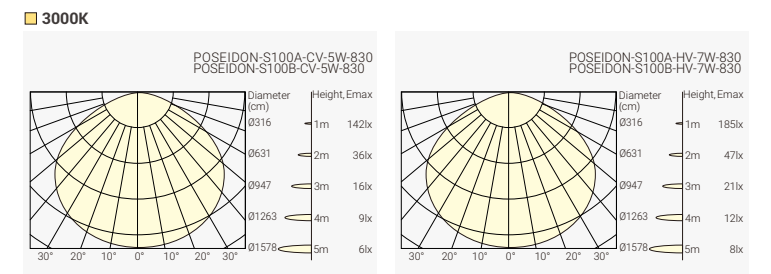

Accessory

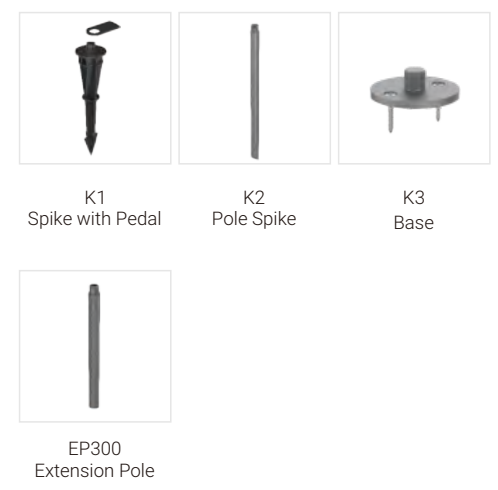

Order Info

24VDC Version

LED Power	System Power	Voltage	CRI	CCT	System Output	Model	Code
4W	5W	24VDC	80	@2700K	350lm	POSEIDON-S100A-CV	PAV1-8A3C605F-DN-K1
				@3000K	370lm		
				@2700K	350lm	POSEIDON-S100B-CV	PBV1-8A3C605F-DN-K1
				@3000K	370lm		

Code Remark: K1=(Spike with Pedal) K2=(Pole Spike) K3=(Base) Remark: External 24VDC LED Driver is Required

LED Driver Integrated Version

LED Power	System Power	Input	CRI	CCT	System Output	Model	Code
5W	7W	220-240VAC	80	@2700K	460lm	POSEIDON-S100A-HV	PAH1-8A3C607F-DN-K1
				@3000K	485lm		
				@2700K	460lm	POSEIDON-S100B-HV	PBH1-8A3C607F-DN-K1
				@3000K	485lm		

Code Remark: K1=(Spike with Pedal) K2=(Pole Spike) K3=(Base) Remark: On-Off LED Driver Integrated

CALIFORNIA – LED Bollard Lamp

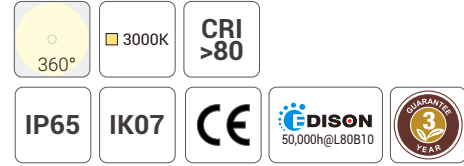
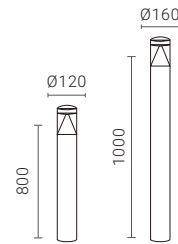
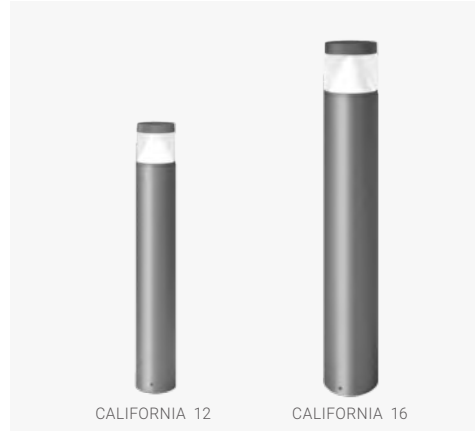

Quick Info

- DISON LED: 11W, 17W, CRI>80, 3000K
- Beam Angle: Light Emission 360°
- Lumen Output: Up to 660lm/ 1220lm System Luminous Flux
- IP Class: IP65
- Body: Aluminum; Color: Dark-Grey
- LED Driver: With internal Non-Dimmable LED driver

Light Distribution

3000K

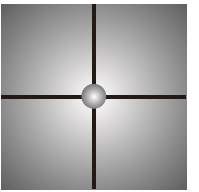
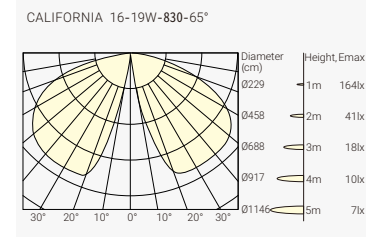
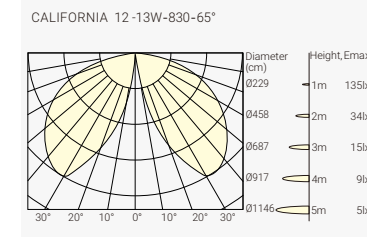

Light Emission 360°

Order Info

LED Power	System Power	Input	CRI	CCT	Beam	System Output	Model	Code
11W	13W	220-240VAC	80	3000K	65°	660lm	CALIFORNIA 12-830	CA12-830C613F-DN
17W	19W	220-240VAC	80	3000K	65°	1220lm	CALIFORNIA 16-830	CA16-830C619F-DN

Remark: With internal Non-Dimmable LED driver



DURBAN – LED Bollard Lamp

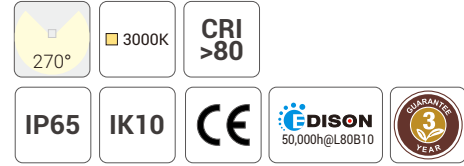

Quick Info

- EDISON LED: 5W, CRI>80, 3000K
- Beam Angle: Light Emission 270°
- Lumen Output: Up to 450lm System Luminous Flux
- IP Class: IP65
- Body: Aluminum; Color: Dark-Grey
- LED Driver: With internal Non-Dimmable LED driver

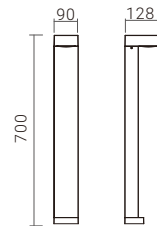

Light Distribution

3000K

CALIFORNIA 12-13W-830-65°

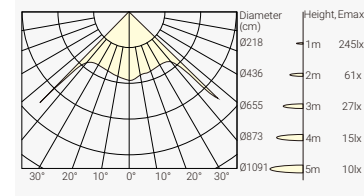

Order Info

LED Power	System Power	Input	CRI	CCT	Beam	System Output	Model	Code
5W	6W	220-240VAC	80	3000K	270°	450lm	DURBAN-830	DURB-830B706F-DN

Remark: With internal Non-Dimmable LED driver

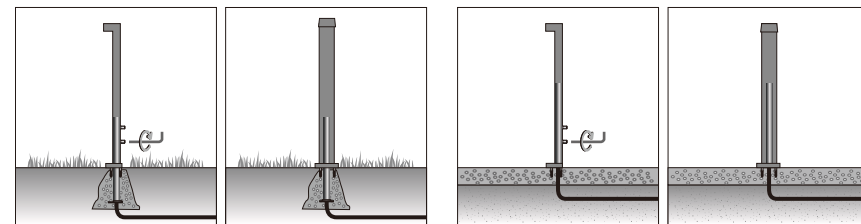

Anchorage installation

Surface installation

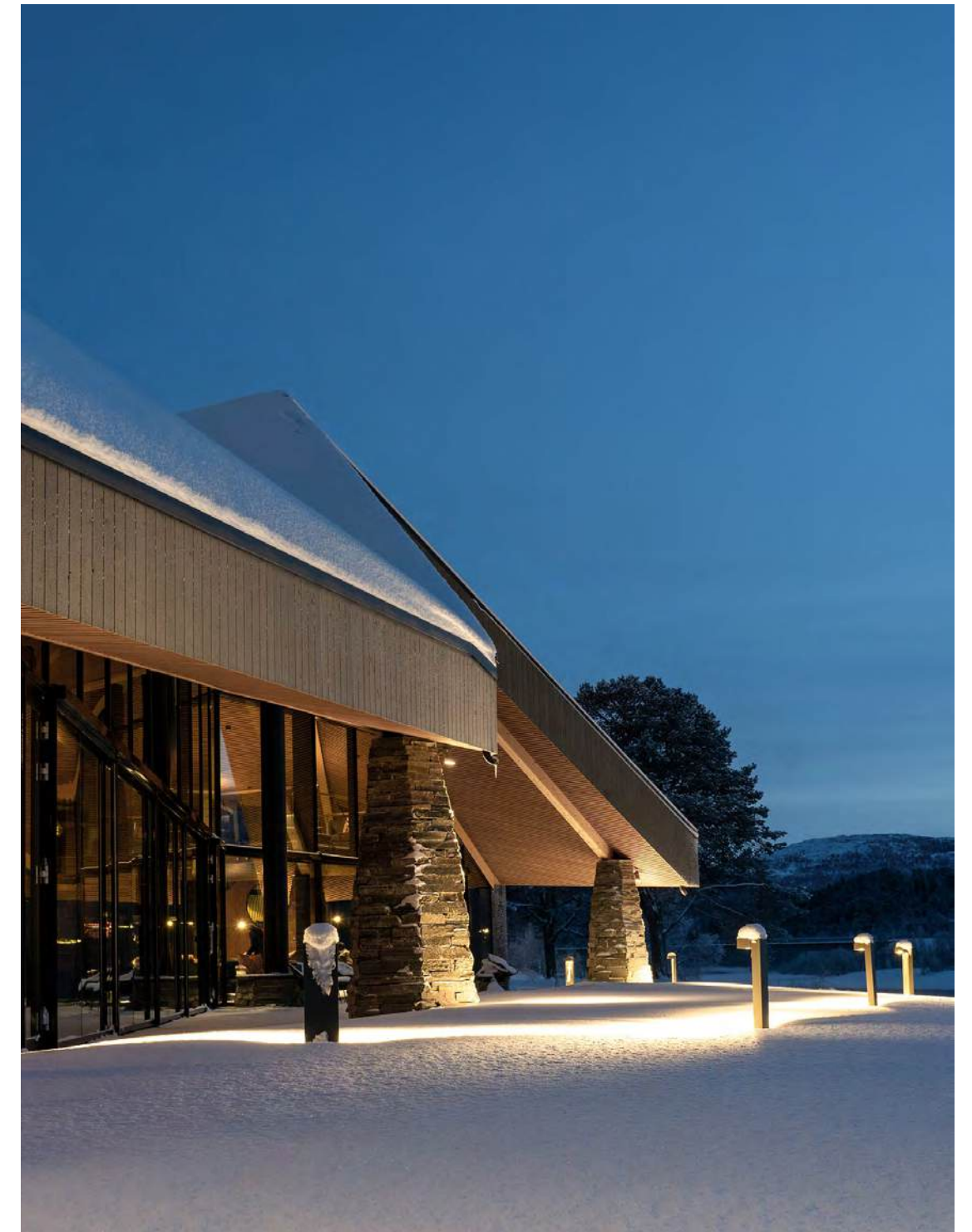

Light Emission 270°

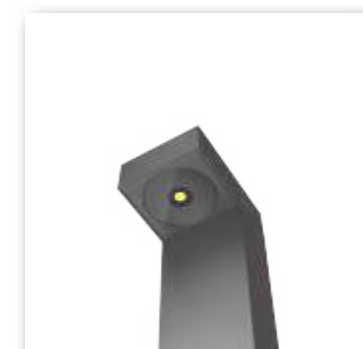

POSITANO – LED Bollard Lamp



POSITANO 300 POSITANO 600

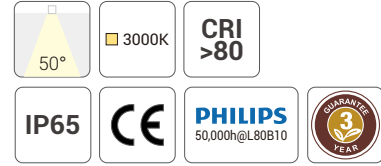
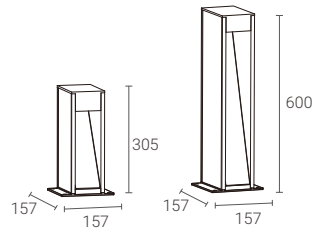

Quick Info

- PHILIPS LED: 5W, CRI>80, 3000K
- Beam Angle: 50°
- Lumen Output: Up to 200lm System Luminous Flux
- IP Class: IP65
- Body: Aluminum; Color: Dark-Grey
- LED Driver: With internal Non-Dimmable LED driver

Light Distribution

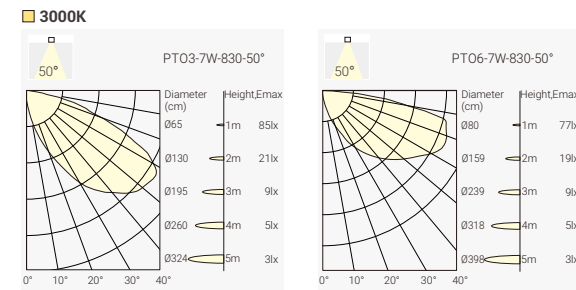

Order Info

LED Power	System Power	Input	CRI	CCT	Beam	System Output	Model	Code
5W	7W	220-240VAC	80	3000K	50°	200lm	POSITANO 300-830	PTO3-8305007F-DN
							POSITANO 600-830	PTO6-8305007F-DN

Remark: With internal Non-Dimmable LED driver



PORTOFINO – Projector Light



PORTOFINO S

PORTOFINO L

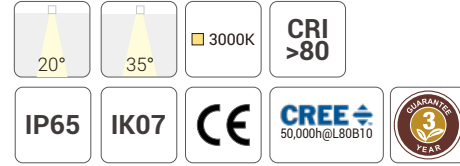
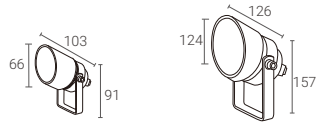

Quick Info

- CREE LED: 3W, 11W, CRI>80, 3000K
- Beam Angle: 20°, 35°
- Lumen Output: Up to 250lm/ 1050lm System Luminous Flux
- IP Class: IP65
- Body: Aluminum; Color: Dark-Grey
- LED Driver: With internal Non-Dimmable LED driver

Light Distribution

3000K

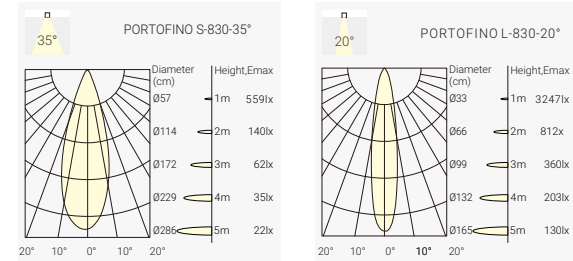

Accessory : Stake for PORTOFINO series projectors



Order Info

LED Power	System Power	Input	CRI	CCT	Beam	System Output	Model	Code
3W	4W	220-240VAC	80	3000K	35°	250lm	PORTOFINO S-830-35°	PORS-8303504F-DN
11W	13W	220-240VAC	80	3000K	20°	1050lm	PORTOFINO L-830-20°	PORL-8302013F-DN

Remark: With internal Non-Dimmable LED driver

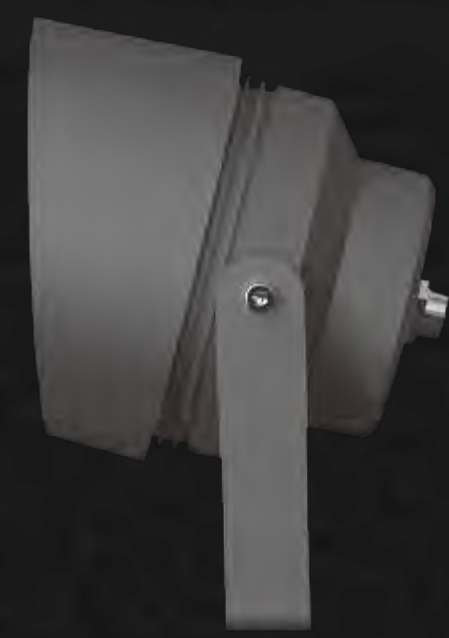

PORTOFINO Adjustable – Beam Angle Zooming Projector Light

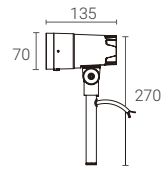

15-60° Zooming
3000K
CRI >80

IP65
IK07
CE
DISON 50,000h@L80B10
3 YEAR WARRANTY

Quick Info

- EDISON LED: 9W, CRI>80, 3000K
- Beam Angle: 15°-60° Zooming
- Lumen Output: Up to 450lm System Luminous Flux
- IP Class: IP65
- Body: Aluminum; Color: Dark-Grey
- LED Driver: With internal Non-Dimmable LED driver

Light Distribution

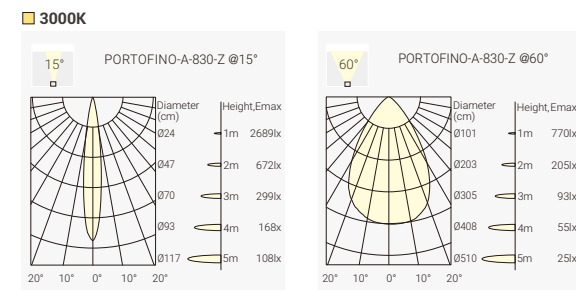

Order Info

LED Power	System Power	Input	CRI	CCT	Beam	System Output	Model	Code
9W	11W	220-240VAC	80	3000K	15°-60°	Max.450lm	PORTOFINO A-830-Z	PORA-830ZM11F-DN

Remark: With internal Non-Dimmable LED driver

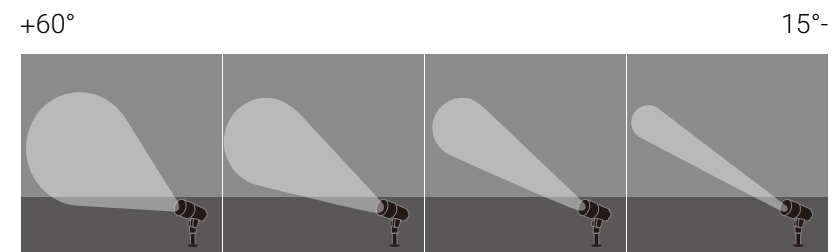

AFTER7 MINI – Projector Light



Quick Info

- CITIZEN LED: 5W, CRI>80, 2700K, 3000K
- Beam Angle: 30°, 45°
- Lumen Output: Up to 500lm System Luminous Flux
- IP Class: IP67
- Body: Aluminum; Color: Dark-Grey
- LED Driver: Remote 24VDC LED driver is required (Non-Dimmable)

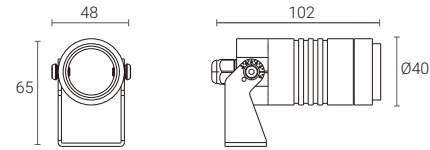

Light Distribution

3000K

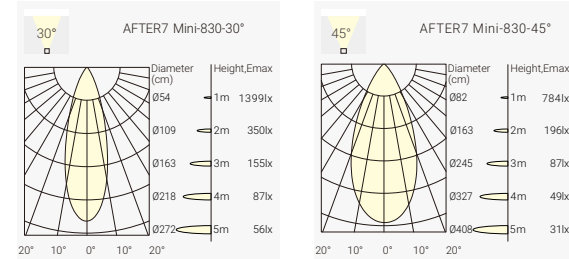

Versions



Order Info

LED Power	System Power	LED Voltage	CRI	CCT	Beam	System Output	Model	Code				
5W	5.5W	24V	80	2700K	30°	480lm	AFTER7 Mini-827-30°	AFMI-8273006F-DN				
					45°	480lm	AFTER7 Mini-827-45°	AFMI-8274506F-DN				
					30°	450lm	AFTER7 Mini-82730°-H	AFMI-8273006F-DN-H				
					45°	450lm	AFTER7 Mini-827-45°-H	AFMI-8274506F-DN-H				
					3000K	30°	500lm	AFTER7 Mini-830-30°	AFMI-8303006F-DN			
						45°	500lm	AFTER7 Mini-830-45°	AFMI-8304506F-DN			
						30°	470lm	AFTER7 Mini-830-30°-H	AFMI-8303006F-DN-H			
						45°	470lm	AFTER7 Mini-830-45°-H	AFMI-8304506F-DN-H			
										Remark: Remote 24VDC LED driver is required (Non-Dimmable)		

Accessory : Stake for AFTER7 series projectors



AFTER7 MAXI – Projector Light

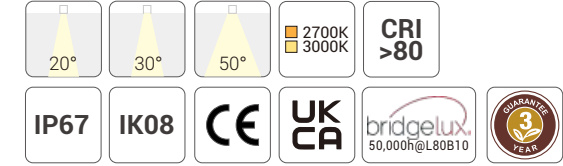

Quick Info

- Bridgelux LED: 9W, CRI>80, 2700K, 3000K
- Beam Angle: 20°, 30°, 50°
- Lumen Output: Up to 850lm System Luminous Flux
- IP Class: IP67
- Body: Aluminum; Color: Dark-Grey
- LED Driver: Remote 24VDC LED driver is required (Non-Dimmable)

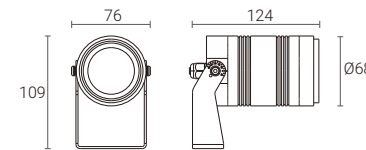

Light Distribution

3000K

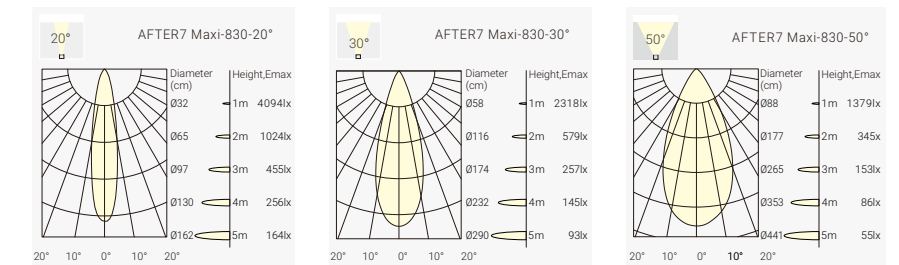

Versions



Order Info

LED Power	System Power	LED Voltage	CRI	CCT	Beam	System Output	Model	Code					
9W	10W	24V	80	2700K	20°	800lm	AFTER7 Maxi-827-20°	AFMA-8272010F-DN					
					30°	800lm	AFTER7 Maxi-827-30°	AFMA-8273010F-DN					
					50°	800lm	AFTER7 Maxi-827-50°	AFMA-8275010F-DN					
					3000K	20°	750lm	AFTER7 Maxi-827-20°-H	AFMA-8272010F-DN				
						30°	750lm	AFTER7 Maxi-827-30°-H	AFMA-8273010F-DN				
						50°	750lm	AFTER7 Maxi-827-50°-H	AFMA-8275010F-DN				
						20°	850lm	AFTER7 Maxi-830-20°	AFMA-8302010F-DN				
						30°	850lm	AFTER7 Maxi-830-30°	AFMA-8303010F-DN				
						50°	850lm	AFTER7 Maxi-830-50°	AFMA-8305010F-DN				
					3000K	20°	800lm	AFTER7 Maxi-830-20°-H	AFMA-8302010F-DN				
						30°	800lm	AFTER7 Maxi-830-30°-H	AFMA-8303010F-DN				
						50°	800lm	AFTER7 Maxi-830-50°-H	AFMA-8305010F-DN				
									Remark: Remote 24VDC LED driver is required (Non-Dimmable)				

Accessory : Stake for AFTER7 series projectors





NEW



IP67

Metaliron grey with triple layer coating for high corrosion and UV resistance

- Chemical conversion coating on the aluminium surface followed by the first layer of anodising
- The second layer of epoxy paint
- The third polyester powder
- Salt spray test passed over 1000hours

Optional accessory

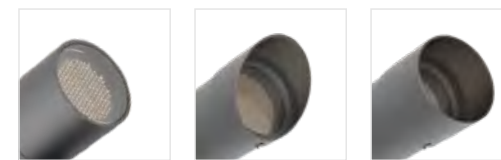

Honeycomb

Bevel Snout

Straight Snout

Accessory



Stake for NEPTUNE series projectors

Models:

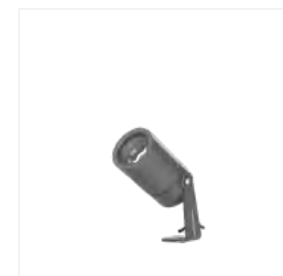

NEPTUNE XSU CV

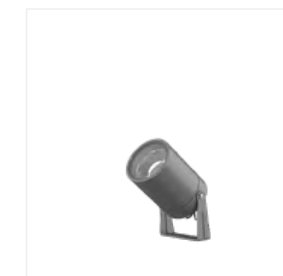

NEPTUNE SU CV



NEPTUNE MU CV



NEPTUNE LU CV

NEPTUNE XSU CV – Projector Light

NEW

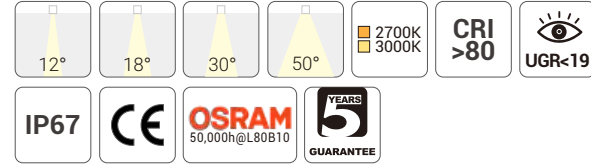

Quick Info

- OSRAM LED: 3W, CRI>80, 2700K, 3000K
- Beam Angle: 12°, 18°, 30°, 50°
- Lumen Output: Up to 150lm System Luminous Flux
- IP Class: IP67
- Body: Aluminum; Color: Dark-Grey
- Compatible with On-Off/ Phase Dim/ 1-10V Dim/ DALI Dim Remote 24VDC LED Driver
- Remote 24VDC LED Driver to be Ordered Separately

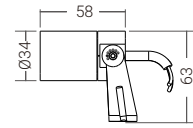

Light Distribution

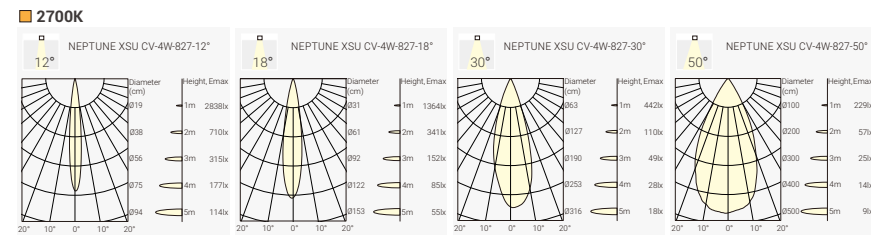

Accessory: Stake for NEPTUNE series projectors



Optional Accessory

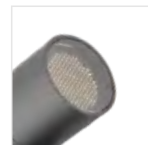

Honeycomb

NEPTUNE SU CV – Projector Light

NEW

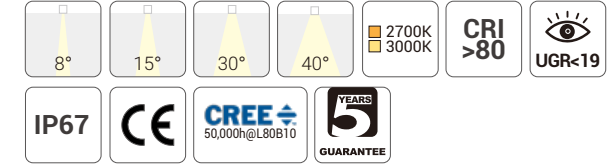

Quick Info

- OSRAM LED: 4W, CRI>80, 2700K, 3000K
- Beam Angle: 8°, 15°, 30°, 40°
- Lumen Output: Up to 420lm System Luminous Flux
- IP Class: IP67
- Body: Aluminum; Color: Dark-Grey
- Compatible with On-Off/ Phase Dim/ 1-10V Dim/ DALI Dim Remote 24VDC LED Driver
- Remote 24VDC LED Driver to be Ordered Separately

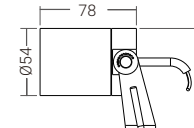

Light Distribution

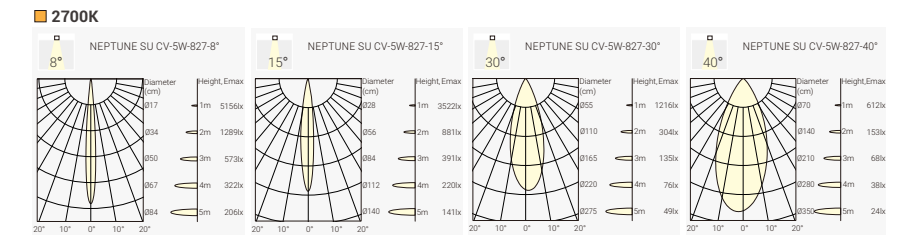

Accessory: Stake for NEPTUNE series projectors



Optional Accessory



Honeycomb

Bevel Snoot

Straight Snoot

Order Info

LED Power	System Power	Voltage	CRI	CCT	Beam	System Output	Model	Code
3W	4W	24VDC	80	2700K	12°	140lm	NEPTUNE XSU-4W-827-12°	NU1C-8271204N-DN
					18°	140lm	NEPTUNE XSU-4W-827-18°	NU1C-8271804N-DN
					30°	140lm	NEPTUNE XSU-4W-827-30°	NU1C-8273004N-DN
					50°	140lm	NEPTUNE XSU-4W-827-50°	NU1C-8275004N-DN
					12°	150lm	NEPTUNE XSU-4W-830-12°	NU1C-8301204N-DN
3000K	4W	24VDC	80	3000K	18°	150lm	NEPTUNE XSU-4W-830-18°	NU1C-8301804N-DN
					30°	150lm	NEPTUNE XSU-4W-830-30°	NU1C-8303004N-DN
					50°	150lm	NEPTUNE XSU-4W-830-50°	NU1C-8305004N-DN

Remark: Compatible with On-Off/ Phase Dim/ 1-10V Dim/ DALI Dim Remote 24VDC LED Driver Remote 24VDC LED Driver to be Ordered Separately

Order Info

LED Power	System Power	Voltage	CRI	CCT	Beam	System Output	Model	Code
4W	5W	24VDC	80	2700K	8°	260lm	NEPTUNE SU-5W-827-8°	NU2C-8270805N-DN
					15°	260lm	NEPTUNE SU-5W-827-15°	NU2C-8271505N-DN
4.2W	5W	24VDC	80	2700K	30°	380lm	NEPTUNE SU-5W-827-30°	NU2C-8273005N-DN
					40°	380lm	NEPTUNE SU-5W-827-40°	NU2C-8274005N-DN
					15°	420lm	NEPTUNE SU-5W-830-15°	NU2C-8301505N-DN
					30°	420lm	NEPTUNE SU-5W-830-30°	NU2C-8303005N-DN
3000K	5W	24VDC	80	3000K	40°	350lm	NEPTUNE SU-5W-830-40°	NU2C-8304005N-DN

Remark: Compatible with On-Off/ Phase Dim/ 1-10V Dim/ DALI Dim Remote 24VDC LED Driver Remote 24VDC LED Driver to be Ordered Separately

NEPTUNE MU CV – Projector Light

NEW



Quick Info

- CREE LED: 11W, CRI>80, 2700K, 3000K
- Beam Angle: 10°, 20°, 30°, 50°
- Lumen Output: Up to 950lm System Luminous Flux
- IP Class: IP67
- Body: Aluminum; Color: Dark-Grey
- Compatible with On-Off/ Phase Dim/ 1-10V Dim/ DALI Dim Remote 24VDC LED Driver
- Remote 24VDC LED Driver to be Ordered Separately

Light Distribution

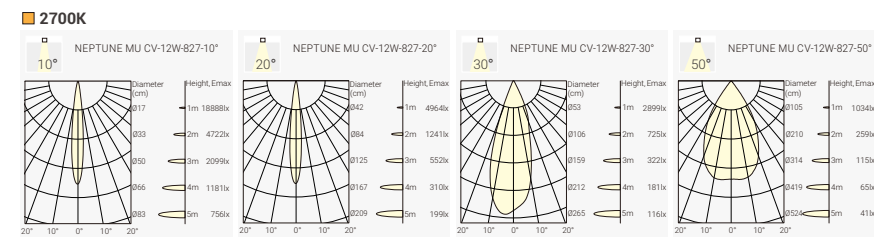
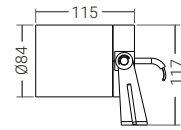

Accessory: Stake for NEPTUNE series projectors



Order Info

LED Power	System Power	Voltage	CRI	CCT	Beam	System Output	Model	Code	
11W	12W	24VDC	80	2700K	10°	800lm	NEPTUNE MU-12W-827-10°	NU3C-8271012N-DN	
					20°	850lm	NEPTUNE MU-12W-827-20°	NU3C-8272012N-DN	
					30°	850lm	NEPTUNE MU-12W-827-30°	NU3C-8273012N-DN	
					50°	800lm	NEPTUNE MU-12W-827-50°	NU3C-8275012N-DN	
					3000K	10°	850lm	NEPTUNE MU-12W-830-10°	NU3C-8301012N-DN
						20°	950lm	NEPTUNE MU-12W-830-20°	NU3C-8302012N-DN
						30°	950lm	NEPTUNE MU-12W-830-30°	NU3C-8303012N-DN
						50°	850lm	NEPTUNE MU-12W-830-50°	NU3C-8305012N-DN

Remark: Compatible with On-Off/ Phase Dim/ 1-10V Dim/ DALI Dim Remote 24VDC LED Driver Remote 24VDC LED Driver to be Ordered Separately

Optional Accessory



Honeycomb Bevel Snoot Straight Snoot

NEPTUNE LU CV – Projector Light

NEW



Quick Info

- CREE LED: 16W, CRI>80, 2700K, 3000K
- Beam Angle: 10°, 10°, 30°, 50°
- Lumen Output: Up to 1600lm System Luminous Flux
- IP Class: IP67
- Body: Aluminum; Color: Dark-Grey
- Compatible with On-Off/ Phase Dim/ 1-10V Dim/ DALI Dim Remote 24VDC LED Driver
- Remote 24VDC LED Driver to be Ordered Separately

Light Distribution

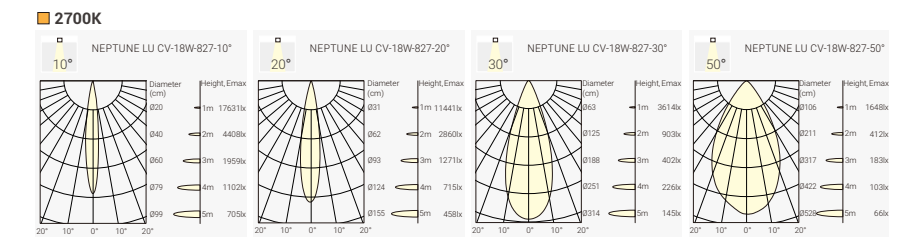
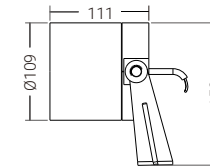

Accessory: Stake for NEPTUNE series projectors



Order Info

LED Power	System Power	Voltage	CRI	CCT	Beam	System Output	Model	Code	
16W	18W	24VDC	80	2700K	10°	1400lm	NEPTUNE LU-18W-827-10°	NU4C-8271018N-DN	
					20°	1450lm	NEPTUNE LU-18W-827-20°	NU4C-8272018N-DN	
					30°	1450lm	NEPTUNE LU-18W-827-30°	NU4C-8273018N-DN	
					50°	1400lm	NEPTUNE LU-18W-827-50°	NU4C-8275018N-DN	
					3000K	10°	1500lm	NEPTUNE LU-18W-830-10°	NU4C-8301018N-DN
						20°	1600lm	NEPTUNE LU-18W-830-20°	NU4C-8302018N-DN
						30°	1600lm	NEPTUNE LU-18W-830-30°	NU4C-8303018N-DN
						50°	1500lm	NEPTUNE LU-18W-830-50°	NU4C-8305018N-DN

Remark: Compatible with On-Off/ Phase Dim/ 1-10V Dim/ DALI Dim Remote 24VDC LED Driver Remote 24VDC LED Driver to be Ordered Separately

Optional Accessory

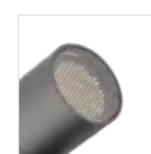

Honeycomb

NEPTUNE Base Version

Standard 24VDC Version

LED Driver Integrated Version Optional

Installation Possibilities:

- 1 -Rear Cable
- 2 -Metal Tube
- 3 -PVC Pipe
- 4 -Direct Cable
- 5 -Corrugated Tube
- 6 -Spike Mounted



NEW

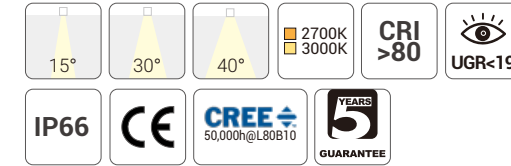

Quick Info

- CREE LED: 4W, CRI>80, 2700K, 3000K
- Beam Angle: 15°, 30°, 40°
- Lumen Output: Up to 420lm System Luminous Flux
- IP Class: IP66
- Body: Aluminum; Color: Dark-Grey
- 24VDC Version: Compatible with On-Off/ Phase Dim/ 1-10V Dim/ DALI Dim Remote 24VDC LED Driver
- LED Driver Integrated Version: On-Off, 220~240VAC Input

Light Distribution

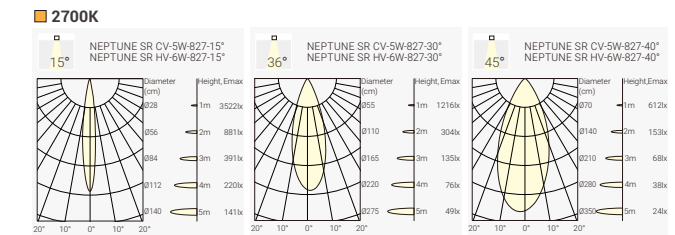

Accessory: Stake for NEPTUNE series projectors



Optional Accessory



Honeycomb Bevel Snoot Straight Snoot

Order Info

24VDC Version

LED Power	System Power	Voltage	CRI	CCT	Beam	System Output	Model	Code	
4W	5W	24VDC	80	2700K	15°	380lm	NEPTUNE SR CV-5W-827-15°	NR1C-8271505F-DN	
					30°	380lm	NEPTUNE SR CV-5W-827-30°	NR1C-8273005F-DN	
					40°	300lm	NEPTUNE SR CV-5W-827-40°	NR1C-8274005F-DN	
					3000K	15°	420lm	NEPTUNE SR CV-5W-830-15°	NR1C-8301505F-DN
						30°	420lm	NEPTUNE SR CV-5W-830-30°	NR1C-8303005F-DN
						40°	350lm	NEPTUNE SR CV-5W-830-40°	NR1C-8304005F-DN

Remark: Compatible with On-Off/ Phase Dim/ 1-10V Dim/ DALI Dim Remote 24VDC LED Driver Remote 24VDC LED Driver to be Ordered Separately

LED Driver Integrated Version

LED Power	System Power	Input	CRI	CCT	Beam	System Output	Model	Code	
4W	6W	220-240VAC	80	2700K	15°	380lm	NEPTUNE SR HV-6W-827-15°	NR1H-8271506F-DN	
					30°	380lm	NEPTUNE SR HV-6W-827-30°	NR1H-8273006F-DN	
					40°	300lm	NEPTUNE SR HV-6W-827-40°	NR1H-8274006F-DN	
					3000K	15°	420lm	NEPTUNE SR HV-6W-830-15°	NR1H-8301506F-DN
						30°	420lm	NEPTUNE SR HV-6W-830-30°	NR1H-8303006F-DN
						40°	350lm	NEPTUNE SR HV-6W-830-40°	NR1H-8304006F-DN

Code Remark: F=(ON-OFF) **Remark:** On-Off LED Driver Integrated, 220~240VAC Input

NEPTUNE MR – Projector Light

NEW



Quick Info

- CREE LED: 11W, CRI>80, 2700K, 3000K
- Beam Angle: 10°, 20°, 30°, 50°
- Lumen Output: Up to 950lm System Luminous Flux
- IP Class: IP66
- Body: Aluminum; Color: Dark-Grey
- 24VDC Version: Compatible with On-Off/ Phase Dim/ 1-10V Dim/ DALI Dim Remote 24VDC LED Driver
- LED Driver Integrated Version: On-Off, 220~240VAC Input

Light Distribution

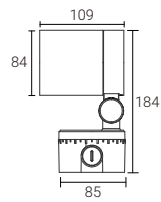
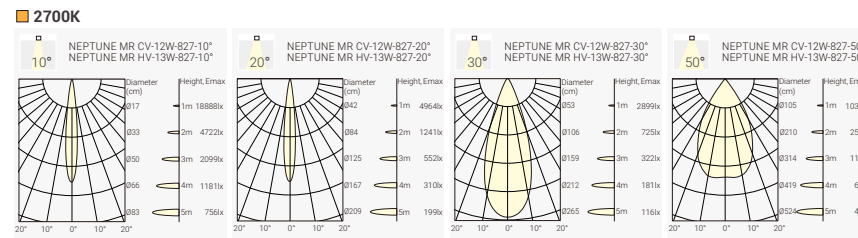

Accessory: Stake for NEPTUNE series projectors



Order Info

24VDC Version

LED Power	System Power	Voltage	CRI	CCT	Beam	System Output	Model	Code	
11W	12W	24VDC	80	2700K	10°	800lm	NEPTUNE MR CV-12W-827-10°	NR2C-8271012F-DN	
					20°	850lm	NEPTUNE MR CV-12W-827-20°	NR2C-8272012F-DN	
					30°	850lm	NEPTUNE MR CV-12W-827-30°	NR2C-8273012F-DN	
					50°	800lm	NEPTUNE MR CV-12W-827-50°	NR2C-8275012F-DN	
					3000K	10°	850lm	NEPTUNE MR CV-12W-830-10°	NR2C-8301012F-DN
						20°	950lm	NEPTUNE MR CV-12W-830-20°	NR2C-8302012F-DN
						30°	950lm	NEPTUNE MR CV-12W-830-30°	NR2C-8303012F-DN
						50°	850lm	NEPTUNE MR CV-12W-830-50°	NR2C-8305012F-DN

Remark: Compatible with On-Off/ Phase Dim/ 1-10V Dim/ DALI Dim Remote 24VDC LED Driver Remote 24VDC LED Driver to be Ordered Separately

LED Driver Integrated Version

LED Power	System Power	Input	CRI	CCT	Beam	System Output	Model	Code	
11W	13W	220-240VAC	80	2700K	10°	800lm	NEPTUNE MR HV-13W-827-10°	NR2H-8271013F-DN	
					20°	850lm	NEPTUNE MR HV-13W-827-20°	NR2H-8272013F-DN	
					30°	850lm	NEPTUNE MR HV-13W-827-30°	NR2H-8273013F-DN	
					50°	800lm	NEPTUNE MR HV-13W-827-50°	NR2H-8275013F-DN	
					3000K	10°	850lm	NEPTUNE MR HV-13W-830-10°	NR2H-8301013F-DN
						20°	950lm	NEPTUNE MR HV-13W-830-20°	NR2H-8302013F-DN
						30°	950lm	NEPTUNE MR HV-13W-830-30°	NR2H-8303013F-DN
						50°	850lm	NEPTUNE MR HV-13W-830-50°	NR2H-8305013F-DN

Code Remark: F=(ON-OFF) Remark: On-Off LED Driver Integrated, 220~240VAC Input

Optional Accessory



Honeycomb Bevel Snoot Straight Snoot

NEPTUNE LR – Projector Light

NEW



Quick Info

- CREE LED: 16W, CRI>80, 2700K, 3000K
- Beam Angle: 10°, 20°, 30°, 50°
- Lumen Output: Up to 1600lm System Luminous Flux
- IP Class: IP66
- Body: Aluminum; Color: Dark-Grey
- 24VDC Version: Compatible with On-Off/ Phase Dim/ 1-10V Dim/ DALI Dim Remote 24VDC LED Driver
- LED Driver Integrated Version: On-Off, 220~240VAC Input

Light Distribution

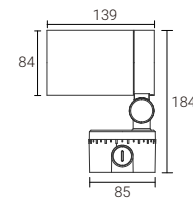
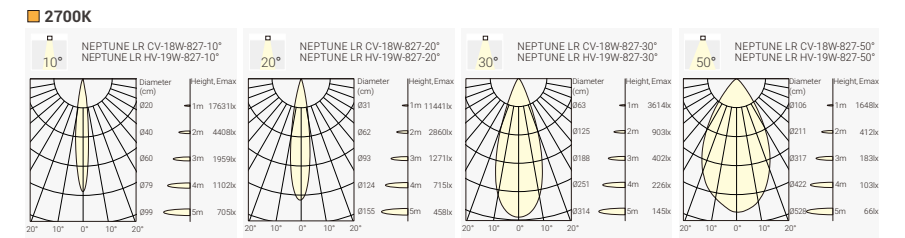

Accessory: Stake for NEPTUNE series projectors



Order Info

24VDC Version

LED Power	System Power	Voltage	CRI	CCT	Beam	System Output	Model	Code	
16W	18W	24VDC	80	2700K	10°	1400lm	NEPTUNE LR CV-18W-827-10°	NR3C-8271018F-DN	
					20°	1450lm	NEPTUNE LR CV-18W-827-20°	NR3C-8272018F-DN	
					30°	1450lm	NEPTUNE LR CV-18W-827-30°	NR3C-8273018F-DN	
					50°	1400lm	NEPTUNE LR CV-18W-827-50°	NR3C-8275018F-DN	
					3000K	10°	1500lm	NEPTUNE LR CV-18W-830-10°	NR3C-8301018F-DN
						20°	1600lm	NEPTUNE LR CV-18W-830-20°	NR3C-8302018F-DN
						30°	1600lm	NEPTUNE LR CV-18W-830-30°	NR3C-8303018F-DN
						50°	1500lm	NEPTUNE LR CV-18W-830-50°	NR3C-8305018F-DN

Remark: Compatible with On-Off/ Phase Dim/ 1-10V Dim/ DALI Dim Remote 24VDC LED Driver Remote 24VDC LED Driver to be Ordered Separately

LED Driver Integrated Version

LED Power	System Power	Input	CRI	CCT	Beam	System Output	Model	Code	
16W	19W	220-240VAC	80	2700K	10°	1400lm	NEPTUNE LR HV-19W-827-10°	NR3H-8271019F-DN	
					20°	1450lm	NEPTUNE LR HV-19W-827-20°	NR3H-8272019F-DN	
					30°	1450lm	NEPTUNE LR HV-19W-827-30°	NR3H-8273019F-DN	
					50°	1400lm	NEPTUNE LR HV-19W-827-50°	NR3H-8275019F-DN	
					3000K	10°	1500lm	NEPTUNE LR HV-19W-830-10°	NR3H-8301019F-DN
						20°	1600lm	NEPTUNE LR HV-19W-830-20°	NR3H-8302019F-DN
						30°	1600lm	NEPTUNE LR HV-19W-830-30°	NR3H-8303019F-DN
						50°	1500lm	NEPTUNE LR HV-19W-830-50°	NR3H-8305019F-DN

Code Remark: F=(ON-OFF) Remark: On-Off LED Driver Integrated, 220~240VAC Input

Optional Accessory

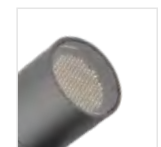

Honeycomb

TERARACE MICRO – Recessed Ground Light

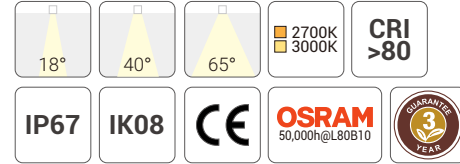

Quick Info

- OSRAM LED: 1W, CRI>80, 2700K, 3000K
- Beam Angle: 18°, 40°, 40°
- Lumen Output: Up to 100lm System Luminous Flux
- IP Class: IP65
- Body: Aluminum; Color: Dark-Grey
- LED Driver: Remote 24VDC LED driver is required (Non-Dimmable)

Light Distribution

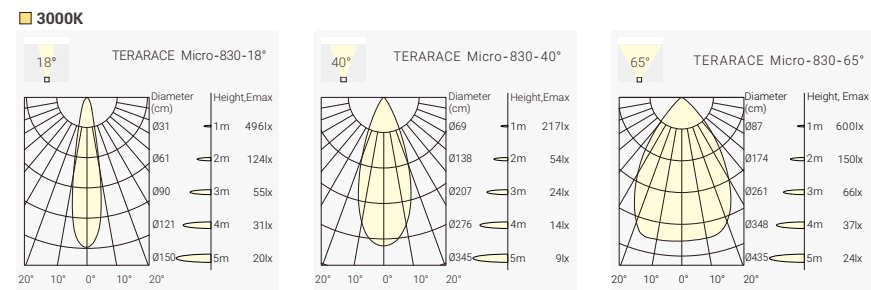

Order Info

LED Power	System Power	LED Voltage	CRI	CCT	Beam	System Output	Model	Code
1W	1.5W	24V	80	2700K	18°	90lm	TERARACE Micro-827-18°	TEMI-8271802F-DN
					40°	90lm	TERARACE Micro-827-40°	TEMI-8274002F-DN
					65°	90lm	TERARACE Micro-827-65°	TEMI-8276502F-DN
					18°	100lm	TERARACE Micro-830-18°	TEMI-8301802F-DN
					40°	100lm	TERARACE Micro-830-40°	TEMI-8304002F-DN
					65°	100lm	TERARACE Micro-830-65°	TEMI-8306502F-DN

Remark: Remote 24VDC LED driver is required (Non-Dimmable)

Accessory: Pre-embedded Tube



TERARACE NANO – Recessed Ground Light

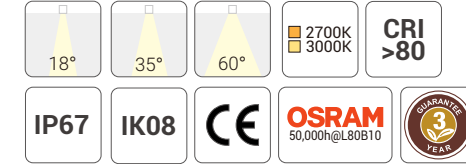

Quick Info

- OSRAM LED: 1.6W, CRI>80, 2700K, 3000K
- Beam Angle: 18°, 35°, 60°
- Lumen Output: Up to 120lm System Luminous Flux
- IP Class: IP67
- Body: Aluminum; Color: Dark-Grey
- LED Driver: Remote 24VDC LED driver is required (Non-Dimmable)

Light Distribution

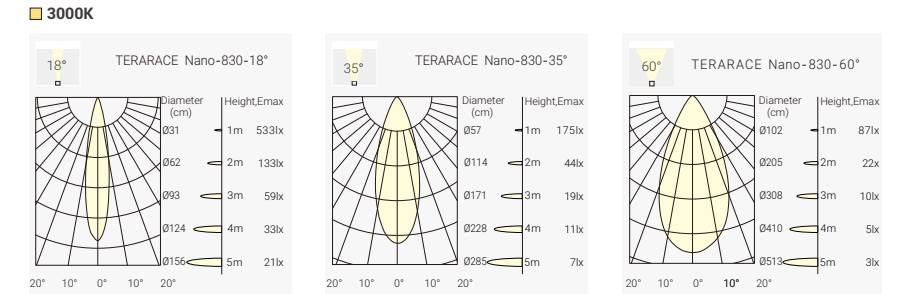

Order Info

LED Power	System Power	LED Voltage	CRI	CCT	Beam	System Output	Model	Code
1.6W	2W	24V	80	2700K	18°	110lm	TERARACE Nano-827-18°	TEMI-8271802F-DN
					35°	110lm	TERARACE Nano-827-35°	TEMI-8273502F-DN
					60°	110lm	TERARACE Nano-827-60°	TEMI-8276002F-DN
					18°	120lm	TERARACE Nano-830-18°	TEMI-8301802F-DN
					35°	120lm	TERARACE Nano-830-35°	TEMI-8303502F-DN
					60°	120lm	TERARACE Nano-830-60°	TEMI-8306002F-DN

Remark: Remote 24VDC LED driver is required (Non-Dimmable)

Accessory: Pre-embedded Tube



TERARACE MICRO – Recessed Ground Light

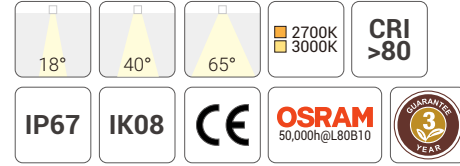

Quick Info

- OSRAM LED: 1W, CRI>80, 2700K, 3000K
- Beam Angle: 18°, 40°, 40°
- Lumen Output: Up to 100lm System Luminous Flux
- IP Class: IP65
- Body: Aluminum; Color: Dark-Grey
- LED Driver: Remote 24VDC LED driver is required (Non-Dimmable)

Light Distribution

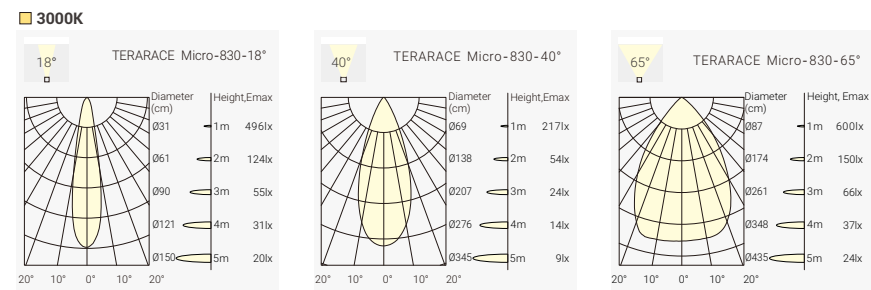

Order Info

LED Power	System Power	LED Voltage	CRI	CCT	Beam	System Output	Model	Code
1W	1.5W	24V	80	2700K	18°	90lm	TERARACE Micro-827-18°	TEMI-8271802F-DN
					40°	90lm	TERARACE Micro-827-40°	TEMI-8274002F-DN
					65°	90lm	TERARACE Micro-827-65°	TEMI-8276502F-DN
					18°	100lm	TERARACE Micro-830-18°	TEMI-8301802F-DN
					40°	100lm	TERARACE Micro-830-40°	TEMI-8304002F-DN
					65°	100lm	TERARACE Micro-830-65°	TEMI-8306502F-DN

Remark: Remote 24VDC LED driver is required (Non-Dimmable)

Accessory: Pre-embedded Tube



TERARACE NANO – Recessed Ground Light

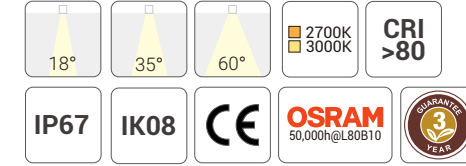

Quick Info

- OSRAM LED: 1.6W, CRI>80, 2700K, 3000K
- Beam Angle: 18°, 35°, 60°
- Lumen Output: Up to 120lm System Luminous Flux
- IP Class: IP67
- Body: Aluminum; Color: Dark-Grey
- LED Driver: Remote 24VDC LED driver is required (Non-Dimmable)

Light Distribution

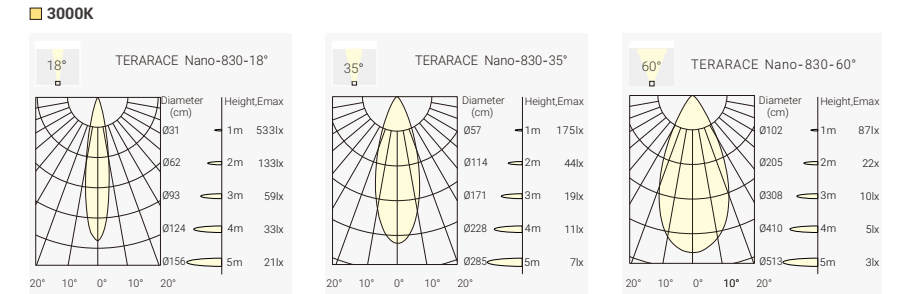

Order Info

LED Power	System Power	LED Voltage	CRI	CCT	Beam	System Output	Model	Code
1.6W	2W	24V	80	2700K	18°	110lm	TERARACE Nano-827-18°	TEMI-8271802F-DN
					35°	110lm	TERARACE Nano-827-35°	TEMI-8273502F-DN
					60°	110lm	TERARACE Nano-827-60°	TEMI-8276002F-DN
					18°	120lm	TERARACE Nano-830-18°	TEMI-8301802F-DN
					35°	120lm	TERARACE Nano-830-35°	TEMI-8303502F-DN
					60°	120lm	TERARACE Nano-830-60°	TEMI-8306002F-DN

Remark: Remote 24VDC LED driver is required (Non-Dimmable)

Accessory: Pre-embedded Tube



TERARACE MINI – Recessed Ground Light

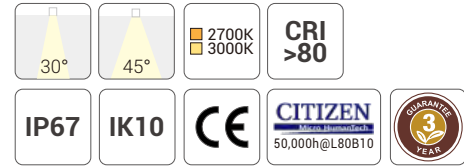

Quick Info

- CITIZEN LED: 5 W, CRI>80, 2700K, 3000K
- Beam Angle: 30°, 45°
- Lumen Output: Up to 500lm System Luminous Flux
- IP Class: IP67
- Body: Aluminum; Color: Dark-Grey
- LED Driver: Remote 24VDC LED driver is required (Non-Dimmable)

Light Distribution

3000K

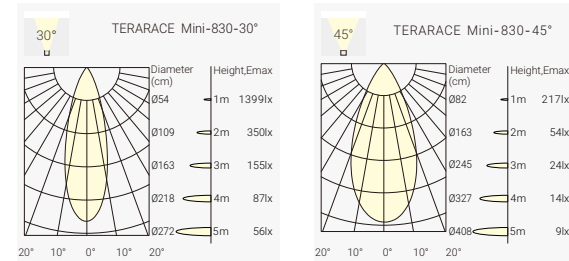

Order Info

LED Power	System Power	LED Voltage	CRI	CCT	Beam	System Output	Model	Code
5W	5.5W	24V	80	2700K	30°	480lm	TERARACE Mini-827-30°	TEMI-8273006F-DN
					45°	480lm	TERARACE Mini-827-45°	TEMI-8274506F-DN
					30°	500lm	TERARACE Mini-830-30°	TEMI-8303006F-DN
					45°	500lm	TERARACE Mini-830-45°	TEMI-8304506F-DN

Remark: Remote 24VDC LED driver is required (Non-Dimmable)

Accessory: Pre-embedded Tube

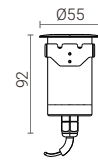

TERARACE MAXI – Recessed Ground Light

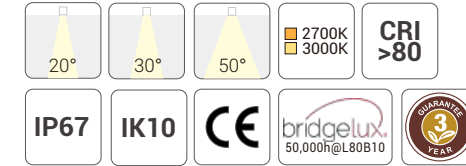

Quick Info

- CITIZEN LED: 9W, CRI>80, 2700K, 3000K
- Beam Angle: 20°, 30°, 45°
- Lumen Output: Up to 850lm System Luminous Flux
- IP Class: IP67
- Body: Aluminum; Color: Dark-Grey
- LED Driver: Remote 24VDC LED driver is required (Non-Dimmable)

Light Distribution

3000K

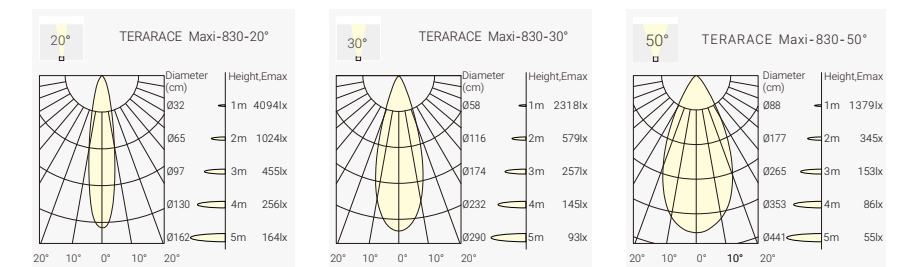

Order Info

LED Power	System Power	LED Voltage	CRI	CCT	Beam	System Output	Model	Code
9W	10W	24V	80	2700K	20°	850lm	TERARACE Maxi-827-20°	TEMA-8272010F-DN
					30°	850lm	TERARACE Maxi-827-30°	TEMA-8273010F-DN
					50°	850lm	TERARACE Maxi-827-50°	TEMA-8275010F-DN
					20°	850lm	TERARACE Maxi-830-20°	TEMA-8302010F-DN
					30°	850lm	TERARACE Maxi-830-30°	TEMA-8303010F-DN
					50°	850lm	TERARACE Maxi-830-50°	TEMA-8305010F-DN

Remark: Remote 24VDC LED driver is required (Non-Dimmable)

Accessory: Pre-embedded Tube

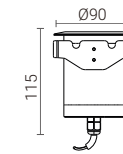

- Headquarters
- Factory
- German Office / Warehouse
- N. America
- UK Office
- France Office
- Beijing Office
- Shanghai Office
- Distributor

- NEKO LIGHTING AG**
Switzerland Headquarters
 Kreuzstrasse 2, CH-8008 Zürich, Switzerland
 Tel: +41 44 451 80 15
 sales@nekolighting.com
 www.nekolighting.com
- NEKO LIGHTING LTD.**
China Factory
 Huizhou, P.R.China | P.C.: 516057
 Tel: +86 755 3669 7712
 sales@nekolighting.com
 www.nekolighting.com
- NEKO LIGHTING GmbH**
German Office / Warehouse
 Lange Reihe 170, 59071 Hamm, Germany
 Tel: +49 2381 8770960
 sales@nekolighting.de
 www.nekolighting.de
- NEKO LIGHTING INC.**
Canada Office
 3025 Bates Road, Montreal, QC H3S 2W8, Canada
- USA Office**
 132 32nd Street, Suite 313, Brooklyn, NY 11232, USA
 Tel: +1 855 LED NEKO (533 6356)
 sales@nekolighting.com
- NEKO Lighting Ltd.**
UK Office
 6C Calderdale Business Park, Club Lane,
 Ovenden, Halifax, Hx2 8DB
 andy@nekolightinguk.com
 www.nekolighting.com
- NEKO Lighting**
France Office
 41 rue des dames – 75017 Paris
 +33 1 44 50 20 30
 sales@nekolighting.fr
 www.nekolighting.com
- NEKO Lighting Middle East**
 1905-55 Prism Tower, Business Bay, Dubai
 Tel: +971 50 2426 911
 david@nekolighting.com
- NEKO Beijing Office**
 Room 218, Huaxi Loft, 5th Da Yang Fang Road,
 Chaoyang District, Beijing, P.R.China
 Tel: +86 173 2681 1100
 sales@nekolighting.com
- NEKO Shanghai Office**
 Haiyang Building Room 2811, No. 550, Yan'an East Road,
 Huangpu District, Shanghai, P.R.China
 Tel: +86 189 2602 8927
 jonson@nekolighting.com

- NEKO Lighting**
Indian Office
 M no 901, A. P. Mordaree T.Haveli, Dist.Pune India
 +91 7410700999
 mailto:neko.india@nekolighting.in
- NEKO Lighting**
Mexico Office
 Interlomas No. 39 Int: 601 entre
 Calle Via magna y Calle Magno Centro,
 Col. La Herradura,
 CP: 52784, Huixquilucan,
 Estado de México, México
 administracion@nekolighting.com.mx
- NEKO Lighting**
Singapore Office
 The Quartz, Singapore
 +65 96442381
 Jeremy@nekolighting.com

